

PLEASE CHECK WWW.MOLEX.COM FOR LATEST PART INFORMATION

Part Number: [5023860270](#)
Status: **Active**
Description: 1.25mm (.049") Pitch CLIK-Mate™ Wire-to-Board PCB Receptacle, Single Row, Right Angle, 2 Circuits

Documents:

[3D Model](#) [Product Specification PS-502382-001 \(PDF\)](#)
[Drawing \(PDF\)](#) [Related Catalog Page \(PDF\)](#)
[Application Specification \(PDF\)](#)

General

Product Family PCB Receptacles
 Series [502386](#)
 Application Wire-to-Board
 Product Name CLIK-Mate™

Physical

Circuits (Loaded) 2
 Circuits (maximum) 2
 Color - Resin Natural
 Durability (mating cycles) min 30 cycles
 Guide to Mating Part Yes
 Keying to Mating Part Yes
 Lock to Mating Part Yes
 Mated Height (in) 0.219 In
 Mated Height (mm) 5.55 mm
 Material - Plating Mating Tin
 Material - Plating Termination Tin
 Material - Resin High Temperature Thermoplastic
 Number of Rows 1
 Orientation Right Angle
 PCB Locator No
 PCB Retention None
 Packaging Type Embossed Tape on Reel
 Pitch - Mating Interface (in) 0.049 In
 Pitch - Mating Interface (mm) 1.25 mm
 Pitch - Term. Interface (in) 0.049 In
 Pitch - Term. Interface (mm) 1.25 mm
 Plating min: Mating (µin) 40
 Plating min: Mating (µm) 1
 Plating min: Termination (µin) 40
 Plating min: Termination (µm) 1
 Polarized to Mating Part Yes
 Polarized to PCB No
 Stackable No
 Surface Mount Compatible (SMC) Yes
 Temperature Range - Operating -25°C to +85°C
 Termination Interface: Style Surface Mount

Electrical

Current - Maximum 1.000 Amp
 Voltage - Maximum 50V AC(RMS)/DC

Material Info

Reference - Drawing Numbers

Product Specification PS-502382-001
 Sales Drawing SD-502386-001

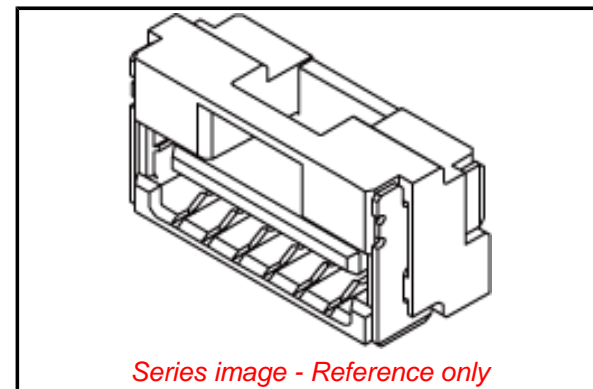

Series image - Reference only

EU RoHS

**ELV and RoHS
Compliant**

China RoHS



**Need more information on product
environmental compliance?**

Email productcompliance@molex.com
 Please visit the [Contact Us](#) section for any
 non-product compliance questions.

Search Parts in this Series

[502386](#) Series

Mates With

[502380](#) Crimp Housing

This document was generated on 01/06/2009

PLEASE CHECK WWW.MOLEX.COM FOR LATEST PART INFORMATION



PRODUCT SPECIFICATION



LANGUAGE
JAPANESE
ENGLISH

【1. 適用範囲 SCOPE】

本仕様書は、_____ 殿 に納入する
_____ 1.25mm ピッチ 電線対基板 コネクタ (1列品) _____ について規定する。
This specification covers the 1.25 mm PITCH WIRE TO BOARD CONNECTOR (SINGLE TYPE) series

【2. 製品名称及び型番 PRODUCT NAME AND PART NUMBER】

製品名称 Product Name		製品型番 Part Number
プラグ ターミナル Plug Terminal	無鉛 LEAD FREE	502381-0000
プラグハウジング (フリクションロック付き) Plug Housing (With Friction Lock)		502380-***00
ストレートリセアセンブリ Straight Receptacle Assembly	無鉛 LEAD FREE	502382-***09
502382 エンボス梱包品 Embossed Tape Packaging For 502382-***09	無鉛 LEAD FREE	502382-***70
ライトアングルリセアセンブリ Right Angle Receptacle Assembly	無鉛 LEAD FREE	502386-***09
502386 エンボス梱包品 Embossed Tape Packaging For 502386-***09	無鉛 LEAD FREE	502386-***70

*: 図面参照 Refer to the drawing.

【3. 定格及び適用電線 RATINGS AND APPLICABLE WIRES】

項目 Item	規格 Standard	
最大許容電圧 Rated Voltage (MAX.)	50 V	
最大許容電流及び適用電線 Rated Current (MAX.) and Applicable wires	AWG#26	1.0A
	AWG#28	1.0A
使用温度範囲 Ambient Temperature Range	-25℃ ~ +85℃ *1 低温において氷結しないこと Not freeze to low temperature	

*1: 通電による温度上昇分も含む。 Including terminal temperature rise.

作成	A	B	C																
SHEET	1-11	1-11	1-11																
REVISE ON PC ONLY							TITLE: 1.25mm PITCH WIRE TO BOARD CONNECTOR SINGLE TYPE												
C	変更 REVISED J2007-3489 '07/06/22 K.SETO						製品仕様書												
	THIS DOCUMENT CONTAINS INFORMATION THAT IS PROPRIETARY TO MOLEX INC. AND SHOULD NOT BE USED WITHOUT WRITTEN PERMISSION																		
REV.	DESCRIPTION																		
DESIGN CONTROL J				STATUS		WRITTEN BY: T.MIYAZAKI	CHECKED BY: K.ASAKAWA	APPROVED BY: YO.ITO	DATE : YR/MO/DAY 2006/10/27										
DOCUMENT NUMBER PS-502382-001														FILE NAME PS502382001.doc	SHEET 1 OF 11				



【4. 性能 PERFORMANCE】

4-1. 電氣的性能 Electrical performance

項目 Item		条件 Test Condition	規格 Requirement
4-1-1	接触抵抗 Contact Resistance	コネクタを嵌合させ、開放電圧 20mV以下、短絡電流 10mA にて測定する。 (JIS C5402 5.4) Mate connectors and measured by dry circuit, 20mV MAX., 10mA. (JIS C5402 5.4)	20 milliohms MAX.
4-1-2	絶縁抵抗 Insulation Resistance	コネクタを嵌合させ、隣接するターミナル間及びターミナル、アース間に、DC 250Vを印加し測定する。 (JIS C5402 5.2/MIL-STD-202 試験法 302) Mate connectors and apply 250V DC between adjacent terminal or ground. (JIS C5402 5.2/MIL-STD-202 Method 302)	100 Megohms MIN.
4-1-3	耐電圧 Dielectric Strength	コネクタを嵌合させ、隣接するターミナル間及びターミナル、アース間に、AC(rms) 500V (実効値) を1分間 印加する。感度電流 2mA (JIS C5402 5.1/MIL-STD-202 試験法 301) Mate connectors and apply 500V AC(rms) for 1 minute between adjacent terminal or ground. Trip current 2mA. (JIS C5402 5.1/MIL-STD-202 Method 301)	異常なきこと No Breakdown
4-1-4	圧着部接触抵抗 Contact Resistance on Crimped Portion	ターミナルに適合電線を圧着し、開放電圧20mV以下、短絡電流 10mA にて測定する。 Crimp the applicable wire to the terminal, measured by dry circuit, 20mV MAX., 10mA.	5 milliohms MAX.

REVISE ON PC ONLY		TITLE: 1.25mm PITCH WIRE TO BOARD CONNECTOR SINGLE TYPE 製品仕様書	
C	SEE SHEET 1		
REV.	DESCRIPTION	THIS DOCUMENT CONTAINS INFORMATION THAT IS PROPRIETARY TO MOLEX INC. AND SHOULD NOT BE USED WITHOUT WRITTEN PERMISSION	
DOCUMENT NUMBER PS-502382-001		FILE NAME PS502382001.doc	SHEET 2 OF 11



4 - 2. 機械的性能 Mechanical Performance

項目 Item		条件 Test Condition		規格 Requirement
4-2-1	挿入力及び抜去力 Insertion and Withdrawal Force	手挿抜にて挿入、抜去を行う。 Insert and withdraw connectors with hand.		第6項参照 Refer to paragraph 6
4-2-2	圧着部引張強度 Crimping Pull out Force	圧着されたターミナルを治具に 固定し、電線を軸方向に 毎分25±3mmの速さで引張る。 (JIS C5402 6.8)	AWG#26	9.8N{1.0kgf}MIN.
		Fix the crimped terminal, apply axial pull out force on the wire at the speed rate of 25±3mm/minute. (JIS C5402 6.8)	AWG#28	9.8N{1.0kgf}MIN.
4-2-3	ターミナル挿入力 Terminal Insertion Force	圧着されたターミナルをハウジングに挿入する。 Insert the crimped terminal into the housing.		4.9N { 0.5kgf } MAX.
4-2-4	プラグターミナル 保持力 Plug Terminal Retention Force	プラグハウジングに装着されたプラグターミナルを 毎分 1~5mm/sec の速さで引張る。 Apply axial pull out force at the speed rate of 1~5mm/sec on the plug terminal assembled in the plug housing.		6.9N {0.7 kgf} MIN.
4-2-5	リセターミナル 保持力 Rec. Terminal Retention Force	リセハウジングに装着されたターミナルを 毎分 25±3mm の速さで軸方向に引張る。 Apply axial pull out force at the speed rate of 25±3mm/minute on the rec. terminal assembled in the rec. housing.		2.94N {0.3 kgf} MIN.
4-2-6	ハウジングロック強度 (ポジティブロック) Housing Lock Strength (Positive Lock)	ハウジングを嵌合し、軸方向に毎分25±3mmの 速さで引張る。 Mated connectors, and apply axial pull out force at the speed rate of 25±3mm/minute.		19.6N {2 kgf} MIN.

REVISE ON PC ONLY		TITLE: 1.25mm PITCH WIRE TO BOARD CONNECTOR SINGLE TYPE 製品仕様書
C	SEE SHEET 1	
REV.	DESCRIPTION	THIS DOCUMENT CONTAINS INFORMATION THAT IS PROPRIETARY TO MOLEX INC. AND SHOULD NOT BE USED WITHOUT WRITTEN PERMISSION

DOCUMENT NUMBER PS-502382-001	FILE NAME PS502382001.doc	SHEET 3 OF 11
---	------------------------------	------------------



PRODUCT SPECIFICATION



LANGUAGE
JAPANESE
ENGLISH

4-3. その他 Environmental Performance and Others

項目 Item		条件 Test Condition	規格 Requirement	
4-3-1	挿抜寿命 Repeated Insertion / Withdrawal	1分間 10回 以下の速さで、手挿抜にて挿入、抜去を30回 繰返す。 When mated up to 30 cycles repeatedly by the rate of 10 cycles per minute with hand.	接触抵抗 Contact Resistance	40 milliohms MAX.
4-3-2	温度上昇 Temperature Rise	全ての圧着端子を最小導体の電線で直列に接続し定格電圧/電流で熱平衡に達した時の温度上昇を熱電対で測定する。 (但し、抵抗負荷) All crimp-style terminal shall be connected in a direct series by minimum AWG. The temperature rise shall be measured by thermocouple when the terminal reaches terminal equilibrium under rated voltage / rated current. (However with resistive load)	温度上昇 Temperature Rise	30 °C MAX.
4-3-3	耐振動性 Vibration	DC 1mA 通電状態にて、嵌合軸を含む互いに垂直な 3方向に 掃引割合 10~55~10 Hz/分、全振幅 1.52mm の振動を各2時間 加える。 (MIL-STD-202 試験法 201) Mate connectors and subject to the following vibration conditions, for a period of 2 hours in each of 3 mutually perpendicular axes, passing DC 1mA during the test. Amplitude : 1.52mm P-P Frequency : 10~55~10 Hz in 1 minute. Duration : 2 hours in each X.Y.Z.axes. (MIL-STD-202 Method 201)	外観 Appearance	異状なきこと No Damage
			接触抵抗 Contact Resistance	40 milliohms MAX.
			瞬断 Discontinuity	1 microsecond MAX.
4-3-4	耐衝撃性 Mechanical Shock	DC 1mA 通電状態にて、嵌合軸を含む互いに垂直な 6方向に 490m/s ² { 50G }、作用時間 11msの衝撃を 各3回 加える。 (JIS C0041/MIL-STD-202 試験法 213) Mate connectors and subject to the following shock conditions. 3 shocks shall be applied along 3 mutually perpendicular axes, passing DC 1 mA current during the test. (Total of 18 shocks) Test pulse : Half Sine Peak value : 490 m/s ² (50 G) Duration : 11 ms (JIS C0041/MIL-STD-202 Method 213)	外観 Appearance	異状なきこと No Damage
			接触抵抗 Contact Resistance	40 milliohms MAX.
			瞬断 Discontinuity	1 microsecond MAX.

REVISE ON PC ONLY		TITLE: 1.25mm PITCH WIRE TO BOARD CONNECTOR SINGLE TYPE 製品仕様書
C	SEE SHEET 1	
REV.	DESCRIPTION	THIS DOCUMENT CONTAINS INFORMATION THAT IS PROPRIETARY TO MOLEX INC. AND SHOULD NOT BE USED WITHOUT WRITTEN PERMISSION
DOCUMENT NUMBER PS-502382-001		FILE NAME PS502382001.doc
		SHEET 4 OF 11



PRODUCT SPECIFICATION



LANGUAGE

JAPANESE
ENGLISH

項 目 Item		条 件 Test Condition	規 格 Requirement	
4-3-5	耐熱性 Heat Resistance	コネクタを嵌合させ、85±2℃ の雰囲気中に96時間放置後取り出し、1時間室温に放置する。 (JIS C60068-2-2/MIL-STD-202 試験法 108) Mate connectors and expose to 85±2℃ for 96 hours. Upon completion of the exposure period, the test specimens shall be conditioned at ambient room conditions for 1 hour , after which the specified measurements shall be performed. (JIS C60068-2-2/MIL-STD-202 Method 108)	外 観 Appearance	異常なきこと No Damage
			接 触 抵 抗 Contact Resistance	40 milliohms MAX
4-3-6	耐寒性 Cold Resistance	コネクタを嵌合させ、-25±3℃ の雰囲気中に96時間 放置後取り出し、1時間 室温に放置する。(JIS C60068-2-1) Mate connectors and expose to -25±3℃ for 96 hours. Upon completion of the exposure period, the test specimens shall be conditioned at ambient room conditions for 1 hour, after which the specified measurements shall be performed. (JIS C60068-2-1)	外 観 Appearance	異常なきこと No Damage
			接 触 抵 抗 Contact Resistance	40 milliohms MAX.
4-3-7	耐湿性 Humidity	コネクタを嵌合させ、40±2℃、相対湿度90~95% の雰囲気中に 96時間 放置後取り出し、1時間 室温に放置する。 (JIS C60068-2-3/MIL-STD-202 試験法 103) Mate connectors and expose to 40±2℃, relative humidity 90 to 95% for 96 hours. Upon completion of the exposure period, the test specimens shall be conditioned at ambient room conditions for 1 to 2 hours, after which the specified measurements shall be performed. (JIS C60068-2-3/MIL-STD-202 Method 103)	外 観 Appearance	異常なきこと No Damage
			接 触 抵 抗 Contact Resistance	40 milliohms MAX.
			絶 縁 抵 抗 Insulation Resistance	4-1-2項満足のこと Must meet 4-1-2
			耐 電 圧 Dielectric Strength	4-1-3項満足のこと Must meet 4-1-3

REVISE ON PC ONLY		TITLE: 1.25mm PITCH WIRE TO BOARD CONNECTOR SINGLE TYPE 製品仕様書
C	SEE SHEET 1	
REV.	DESCRIPTION	THIS DOCUMENT CONTAINS INFORMATION THAT IS PROPRIETARY TO MOLEX INC. AND SHOULD NOT BE USED WITHOUT WRITTEN PERMISSION

DOCUMENT NUMBER PS-502382-001	FILE NAME PS502382001.doc	SHEET 5 OF 11
---	------------------------------	------------------



PRODUCT SPECIFICATION



LANGUAGE

JAPANESE
ENGLISH

項 目 Item		条 件 Test Condition	規 格 Requirement	
4-3-8	温度サイクル Temperature Cycling	<p>コネクタを嵌合させ、$-25\pm 3^{\circ}\text{C}$ に 30分、$+85\pm 2^{\circ}\text{C}$ に 30分 これを1サイクルとし、5サイクル 繰返す。 但し、温度移行時間は 5分以内 とする。 試験後1~2時間 室温に放置する。 (JIS C0025)</p> <p>Mate connectors and subject to the following conditions for 5 cycles. Upon completion of the exposure period, the test specimens shall be conditioned at ambient room conditions for 1 to 2hours, after which the specified measurements shall be performed. 5 cycles of :</p> <p>a) $-25\pm 3^{\circ}\text{C}$ 30 minutes b) $+85\pm 2^{\circ}\text{C}$ 30 minutes (JIS C0025)</p>	外 観 Appearance	異常なきこと No Damage
			接 触 抵 抗 Contact Resistance	40 milliohms MAX.
4-3-10	塩 水 噴 霧 Salt Spray	<p>コネクタを嵌合させ、$35\pm 2^{\circ}\text{C}$ にて $5\pm 1\%$ 重量比の塩水を 48 ± 4時間噴霧し、試験後常温で水洗いした後、室温で乾燥させる。 (JIS C60068-2-11/MIL-STD-202 試験法101)</p> <p>Mate connectors and expose to the following salt mist conditions. Upon completion of the exposure period, salt deposits shall be removed by a gentle wash or dip in running water, after which the specified measurements shall be performed. NaCl solution Concentration : $5\pm 1\%$ Spray time : 48 ± 4 hours Ambient temperature : $35\pm 2^{\circ}\text{C}$ (JIS 60068-2-11/MIL-STD-202 Method 101)</p>	外 観 Appearance	著しいサビの なきこと。 No Damage
			接 触 抵 抗 Contact Resistance	40 milliohms MAX.
4-3-11	耐亜硫酸ガス SO ₂ Gas	<p>コネクタを嵌合させ、$40\pm 2^{\circ}\text{C}$ にて 50 ± 5ppmの亜硫酸ガス中に24時間放置する。 Mated connectors and expose to the conditions of 50 ± 5ppm SO₂ gas ambient temperature $40\pm 2^{\circ}\text{C}$ for 24 hours.</p>	外 観 Appearance	異常なきこと No Damage
			接 触 抵 抗 Contact Resistance	40 milliohms MAX.

REVISE ON PC ONLY		TITLE: 1.25mm PITCH WIRE TO BOARD CONNECTOR SINGLE TYPE 製品仕様書
C	SEE SHEET 1	
REV.	DESCRIPTION	THIS DOCUMENT CONTAINS INFORMATION THAT IS PROPRIETARY TO MOLEX INC. AND SHOULD NOT BE USED WITHOUT WRITTEN PERMISSION
DOCUMENT NUMBER PS-502382-001		FILE NAME PS502382001.doc
		SHEET 6 OF 11



PRODUCT SPECIFICATION



LANGUAGE

JAPANESE
ENGLISH

項目 Item		条件 Test Condition	規格 Requirement	
4-3-12	耐アンモニア性 Ammonia gas	コネクタを嵌合させ、濃度28%のアンモニア水を入れた容器中に40分間放置する。 (1 Lに対して25m Lの割合) Mated connectors and expose to the conditions of NH3 gas evaporating from 28% Ammonia solution for 40 minutes.	外 観 Appearance	割れ、ヒビ等の 破損なきこと without damage such as cracks or other breaks
			接 触 抵 抗 Contact Resistance	40 milliohms MAX.
4-3-13	半田付け性 Solderability	端子先端より 0.5mm の位置まで、 245±3℃の半田に4~5秒浸す。 Dip soldertails into the molten solder [held at 245±5 degree centigrade] up to 0.5mm from the bottom of the housing for 4~5 seconds.	濡れ性 Solder Wetting	浸漬面積の 90%以上 90% of immersed area must show no voids, pin holes.
4-3-14	半田耐熱性 Resistance to Soldering Heat	リフロー時 第7項の条件にて実施する。 <u>Reflow soldering method</u> Reference reflow condition at 7 clause.	外 観 Appearance	端子ガタ、割れ等 異状なきこと No Damage
		手半田時 端子先端及び金具先端より0.2mmの 位置まで、350±10℃の半田ゴテにて 3~4秒加熱する。 <u>Soldering iron method</u> 0.2mm from terminal tip Solder Temperature : 350±10℃ Soldering Time :3~4 seconds MAX.		

() : 参考規格 Reference Standard
{ } : 参考単位 Reference Unit

【5. 外観形状、寸法及び材質 PRODUCT SHAPE, DIMENSIONS AND MATERIALS】

図面参照 Refer to the drawing.

REVISE ON PC ONLY		TITLE: 1.25mm PITCH WIRE TO BOARD CONNECTOR SINGLE TYPE 製品仕様書
C	SEE SHEET 1	
REV.	DESCRIPTION	THIS DOCUMENT CONTAINS INFORMATION THAT IS PROPRIETARY TO MOLEX INC. AND SHOULD NOT BE USED WITHOUT WRITTEN PERMISSION
DOCUMENT NUMBER PS-502382-001		FILE NAME PS502382001.doc
		SHEET 7 OF 11



【6. 挿入力及び抜去力 INSERTION / WITHDRAWAL FORCE】

極数 No. of CKT	単位 UNIT	挿入力 (最大値) Insertion (MAX.)			抜去力 (最小値) Withdrawal (MIN.)		
		初回 1st	6回目 6th	30回目 30th	初回 1st	6回目 6th	30回目 30th
2	N {kgf}	9.8 { 1.0 }	10.8 { 1.1 }	11.8 { 1.2 }	0.4 { 0.04 }	0.4 { 0.04 }	0.4 { 0.04 }
3	N {kgf}	10.8 { 1.1 }	11.8 { 1.2 }	12.7 { 1.3 }	0.6 { 0.06 }	0.6 { 0.06 }	0.6 { 0.06 }
4	N {kgf}	11.8 { 1.2 }	12.7 { 1.3 }	16.7 { 1.7 }	0.8 { 0.08 }	0.8 { 0.08 }	0.8 { 0.08 }
5	N {kgf}	14.7 { 1.5 }	16.7 { 1.7 }	19.6 { 2.0 }	1.0 { 0.10 }	1.0 { 0.10 }	1.0 { 0.10 }
6	N {kgf}	17.6 { 1.8 }	19.6 { 2.0 }	22.5 { 2.3 }	1.2 { 0.12 }	1.2 { 0.12 }	1.2 { 0.12 }
7	N {kgf}	20.6 { 2.1 }	22.5 { 2.3 }	25.5 { 2.6 }	1.4 { 0.14 }	1.4 { 0.14 }	1.4 { 0.14 }
8	N {kgf}	23.5 { 2.4 }	25.5 { 2.6 }	29.4 { 3.0 }	1.6 { 0.16 }	1.6 { 0.16 }	1.6 { 0.16 }
9	N {kgf}	26.5 { 2.7 }	29.4 { 3.0 }	32.3 { 3.3 }	1.8 { 0.18 }	1.8 { 0.18 }	1.8 { 0.18 }
10	N {kgf}	29.4 { 3.0 }	32.3 { 3.3 }	35.3 { 3.6 }	2.0 { 0.20 }	2.0 { 0.20 }	2.0 { 0.20 }
11	N {kgf}	32.3 { 3.3 }	35.3 { 3.6 }	39.2 { 4.0 }	2.2 { 0.22 }	2.2 { 0.22 }	2.2 { 0.22 }
12	N {kgf}	35.3 { 3.6 }	39.2 { 4.0 }	42.1 { 4.3 }	2.3 { 0.24 }	2.3 { 0.24 }	2.3 { 0.24 }
13	N {kgf}	38.2 { 3.9 }	42.1 { 4.3 }	45.1 { 4.6 }	2.5 { 0.26 }	2.5 { 0.26 }	2.5 { 0.26 }
14	N {kgf}	41.2 { 4.2 }	45.1 { 4.6 }	48.0 { 4.9 }	2.7 { 0.28 }	2.7 { 0.28 }	2.7 { 0.28 }
15	N {kgf}	44.1 { 4.5 }	48.0 { 4.9 }	51.0 { 5.2 }	2.9 { 0.30 }	2.9 { 0.30 }	2.9 { 0.30 }

※ロックを解除して測定 Released lock, and measure. { } :参考単位 Reference Unit

REVISE ON PC ONLY		TITLE:	
C	SEE SHEET 1	1.25mm PITCH WIRE TO BOARD CONNECTOR SINGLE TYPE	
	REV.	DESCRIPTION	製品仕様書
DOCUMENT NUMBER PS-502382-001		THIS DOCUMENT CONTAINS INFORMATION THAT IS PROPRIETARY TO MOLEX INC. AND SHOULD NOT BE USED WITHOUT WRITTEN PERMISSION	
		FILE NAME PS502382001.doc	SHEET 8 OF 11



【7. リフロー条件 REFLOW CONDITION】

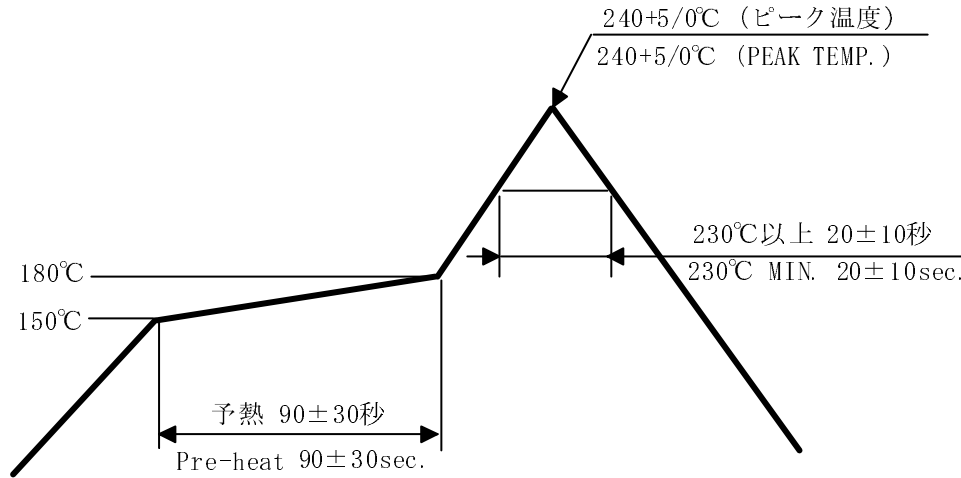

温度条件グラフ
 TEMPERATURE CONDITION GRAPH
 (半田接合部)
 (SOLDER JOINT PART)

注記：本リフロー条件に関しては、リフロー装置及び基板などにより条件が異なりますので
 事前の実装評価(リフロー評価)の御確認を御願い致します。
 端子テール部、ネイルが変色する場合がございますが、半田付け性には問題ありません。
 NOTE : Please check the mount condition (reflow soldering condition) by your own devices
 beforehand, because the condition changes by the soldering devices, p.c.boards, and so on.
 Although tail of terminal and nail may discolors, a solderability does not have a problem

【8. 注記 NOTES】

1. 本製品のプラスチック部に黒点等が確認される場合や色合いが異なる場合がありますが、
製品性能に影響はありません。
There is no influence in the product performance though the black spot etc. might be confirmed to the plastic part of this product and the shade might be different.
2. 本製品は錫めっきを使用しているため、外観に摺動痕がつく場合がございますが、
製品性能に影響はありません。
The wound of friction might adhere to externals because the tin plating is used for the tail and nail. But there is no influence in the product performance.

REVISE ON PC ONLY		TITLE:	
C	SEE SHEET 1	1.25mm PITCH WIRE TO BOARD CONNECTOR SINGLE TYPE	
	REV.	DESCRIPTION	製品仕様書
DOCUMENT NUMBER		THIS DOCUMENT CONTAINS INFORMATION THAT IS PROPRIETARY TO MOLEX INC. AND SHOULD NOT BE USED WITHOUT WRITTEN PERMISSION	
PS-502382-001		FILE NAME	SHEET
		PS502382001.doc	9 OF 11



【9. 取り扱い上の注意事項 INSTRUCTION UPON USAGE】

コネクタの詳細な取り扱いにつきましては、別紙の 1.25 W/B CONN. SINGLE のコネクタ取り扱い説明書を参照して下さい。

Please refer to the manual of the 1.25 W/B connector. SINGLE series for the detailed handling of the connector.

1. 嵌合時にリセハウジングの矢印で示す部位を押し嵌合して下さい。

電線やハウジングのロック部を押した場合、これらが破損する恐れがありますのでお避け下さい。

Please push the part directed by FIG.1 at the time of mate.

It may damage, when electric wires or lock part of the receptacle housing are pushed.



図 1
FIG.1

2. コネクタの嵌合を取り外す際は、必ずロックを解除して行って下さい。

電線はまとめて軽くつかみ、指の平全体で、ロック解除用バーをロック保護壁と共に押してロックを解除し、ゆっくり引き抜いてください。

When unmated connectors, positive locks shall be released.

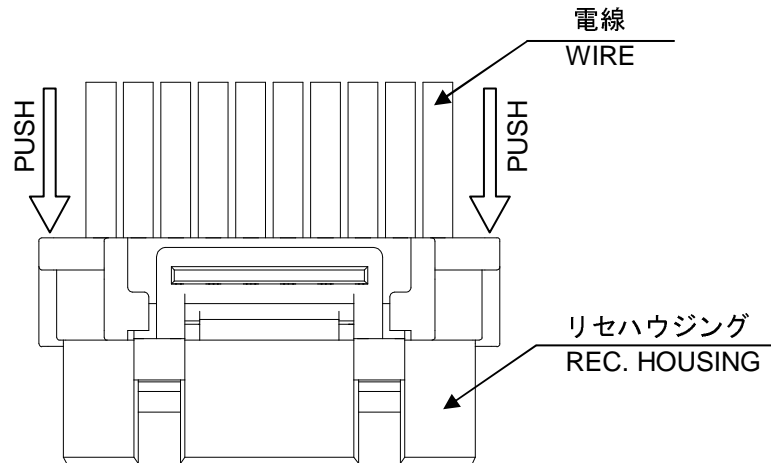
REVISE ON PC ONLY		TITLE:	
C	SEE SHEET 1	1.25mm PITCH WIRE TO BOARD CONNECTOR SINGLE TYPE	
	REV.	DESCRIPTION	製品仕様書
		THIS DOCUMENT CONTAINS INFORMATION THAT IS PROPRIETARY TO MOLEX INC. AND SHOULD NOT BE USED WITHOUT WRITTEN PERMISSION	
DOCUMENT NUMBER PS-502382-001		FILE NAME PS502382001.doc	SHEET 10 OF 11

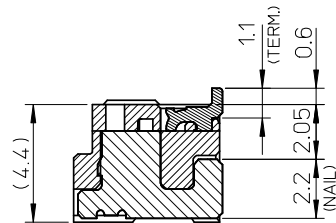
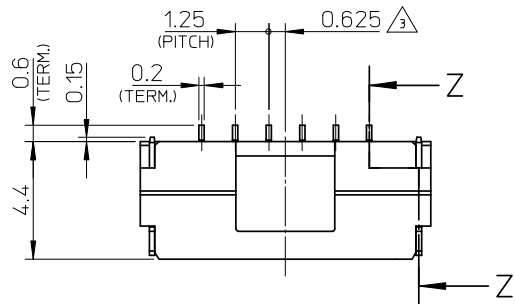

SECTION Z-Z

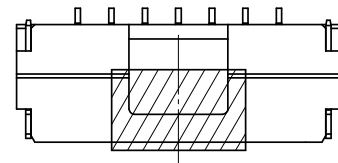

カプトンテープ付き
WITH KAPTON TAPE

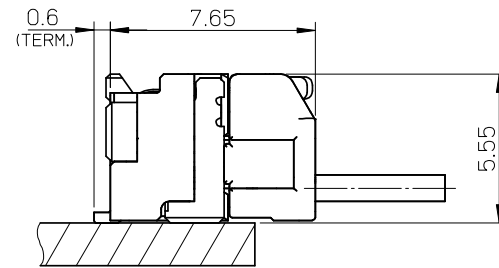
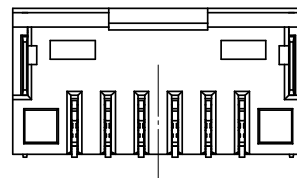
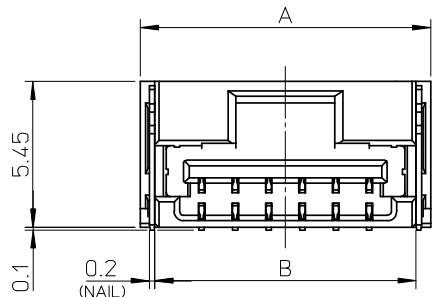
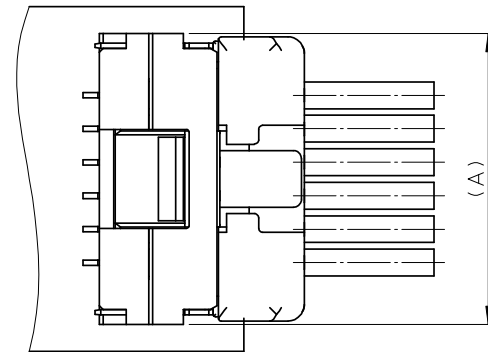

嵌合図

MATED CONNECTORS

NOTES

- 嵌合相手: 502380-****
MATE WITH: 502380-****
- 端子テール部 及び ネイルの平坦度: 0.1MAX.
TAIL AND NAIL COPLANARITY TO BE 0.1 MAX.
- 極数/2=偶数に適用。
APPLY FOR CKT. SIZE / 2 = EVEN.
- 端子テール部 及び ネイルに錫めっきを使用しているため、
外観に摺動痕が付く場合が御座います。
THE WOUND OF FRICTION MIGHT ADHERE TO EXTERNALS
BECAUSE THE TIN PLATING IS USED FOR THA TAIL AND NAIL.
- 本製品のプラスチック部に黒点等が確認される場合や
色合いが異なる場合がありますが、製品性能に影響はありません。
THERE IS NO INFLUENCE IN THE PRODUCT PERFORMANCE THOUGH
THE BLACK SPOT ETC. MIGHT BE CONFIRMED TO THE PLASTIC PART
OF THIS PRODUCT AND THE SHADE MIGHT BE DIFFERENT.
- ELV 及び RoHS 適合品
ELV AND RoHS COMPLIANT

3.4	7.5	11	12.1	502386-0772	502386-0708	502386-0770	502386-0709	7
3.4	6.25	9.75	10.85	502386-0672	502386-0608	502386-0670	502386-0609	6
3.4	5	8.5	9.6	502386-0572	502386-0508	502386-0570	502386-0509	5
3.4	3.75	7.25	8.35	502386-0472	502386-0408	502386-0470	502386-0409	4
2.6	2.5	6	7.1	502386-0372	502386-0308	502386-0370	502386-0309	3
2.2	1.25	4.75	5.85	502386-0272	502386-0208	502386-0270	502386-0209	2
D	C	B	A	EMBOSSD TAPE PACKAGE オーダー番号 ORDER No.	製品番号 MATERIAL NO.	EMBOSSD TAPE PACKAGE オーダー番号 ORDER No.	製品番号 MATERIAL NO.	極数 (KT. NO.)
				WITH CAPTON TAPE		WITHOUT CAPTON TAPE		

番号 NO.	部品 PART	材質 MATERIAL
①	ハウジング HOUSING	耐熱性樹脂 UL94V-0 色: ナチュラル HEATPROOF RESIN UL94V-0 COLOR:NATURAL
②	ターミナル TERMINAL	銅合金 COPPER ALLOY
		錫めっき: 1.0 micro-meter MIN. TIN (TAIL AREA)
		ニッケルめっき(下地): 1.0 micro-meter MIN. NICKEL (UNDER PLATING)
③	ネイル NAIL	銅合金 COPPER ALLOY
		錫めっき: 1.0 micro-meter MIN. TIN
		ニッケルめっき(下地): 1.0 micro-meter MIN. NICKEL (UNDER PLATING)

REVISED EC NO: J2008-3785 DRW:KASETO 2008/04/30 CHK:KASAKAWA 2008/05/07 APPR: SICHIKAWA 2008/05/07	GENERAL TOLERANCES (UNLESS SPECIFIED)		DIMENSION STYLE MM ONLY		SCALE 5:1	DESIGN UNITS METRIC	THIRD ANGLE PROJECTION	
	10 UNDER	±0.2	DRAWN BY DATE T. MIYAZAKI 2006/08/28		TITLE 1.25 W/B CONN. SINGLE R/A REC. ASS'Y 2-7CKT.			
	10 OVER 30 UNDER	±0.25	CHECKED BY DATE K. ASAKAWA 2006/08/28		APPROVED BY DATE YO. ITO 2006/08/28			
	30 OVER	±0.3	MATERIAL NO.		DOCUMENT NO.		SHEET NO.	
	ANGULAR ±3 °		DRAFT WHERE APPLICABLE MUST REMAIN WITHIN DIMENSIONS		SEE TABLE		MOLEX INCORPORATED SD-502386-001	
THIS DRAWING CONTAINS INFORMATION THAT IS PROPRIETARY TO MOLEX INCORPORATED AND SHOULD NOT BE USED WITHOUT WRITTEN PERMISSION								

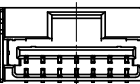
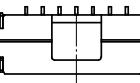
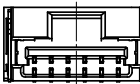
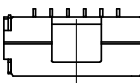
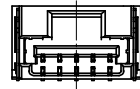
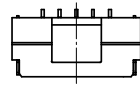

2 CKT.

3 CKT.

4 CKT.

5 CKT.

6 CKT.

7 CKT.

極数の種類
KIND OF CKT. NO.(FRONT VIEW)

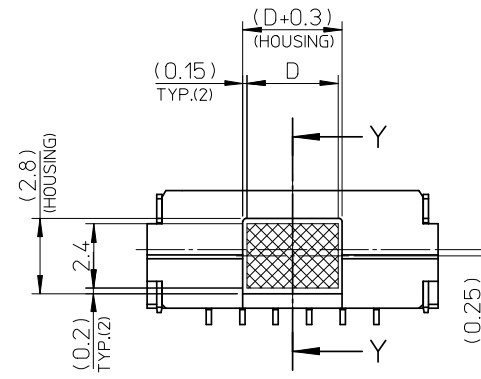

吸着範囲
VACUUM AREA

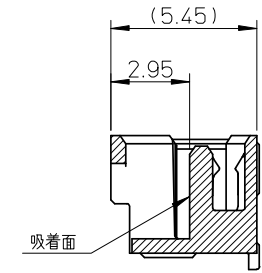

SECTION Y-Y

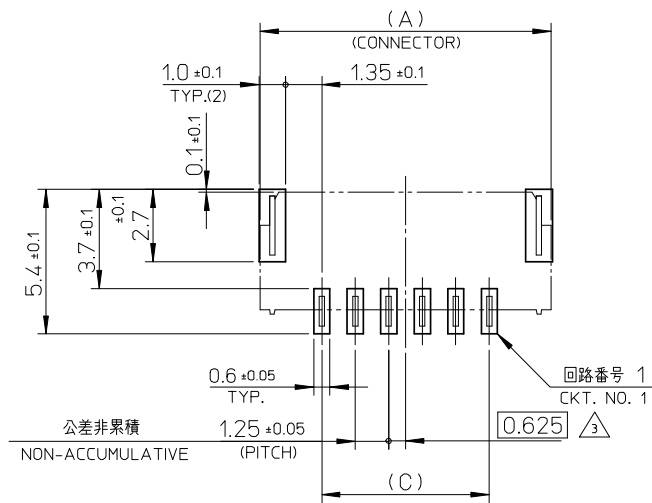

基板パターンレイアウト (参考)
RECOMMENDED P.C.B. PATTERN LAYOUT (REF.)

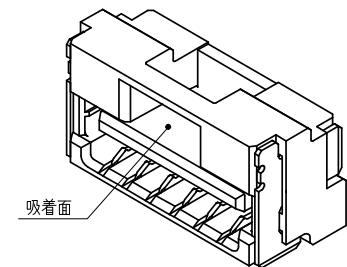

REVISED EC NO: J2008-3785 DRWN:KSETO 2008/04/30 CHKD:KASAKAWA 2008/05/07 APPR: SICHIKAWA 2008/05/07	GENERAL TOLERANCES (UNLESS SPECIFIED)		DIMENSION STYLE MM ONLY		SCALE 5:1	DESIGN UNITS METRIC	THIRD ANGLE PROJECTION	
	10 UNDER	± 0.2	DRAWN BY T. MIYAZAKI	DATE 2006/08/28	TITLE 1.25 W/B CONN. SINGLE R/A REC. ASS'Y 2-7CKT.			
	10 OVER 30 UNDER	± 0.25	CHECKED BY K. ASAKAWA	DATE 2006/08/28	MOLEX INCORPORATED			
	30 OVER	± 0.3	APPROVED BY YO. ITO	DATE 2006/08/28	MATERIAL NO.	DOCUMENT NO.	SHEET NO.	
	ANGULAR	± 3 °	SEE TABLE		SD-502386-001		2 OF 2	
DRAFT WHERE APPLICABLE MUST REMAIN WITHIN DIMENSIONS			THIS DRAWING CONTAINS INFORMATION THAT IS PROPRIETARY TO MOLEX INCORPORATED AND SHOULD NOT BE USED WITHOUT WRITTEN PERMISSION					

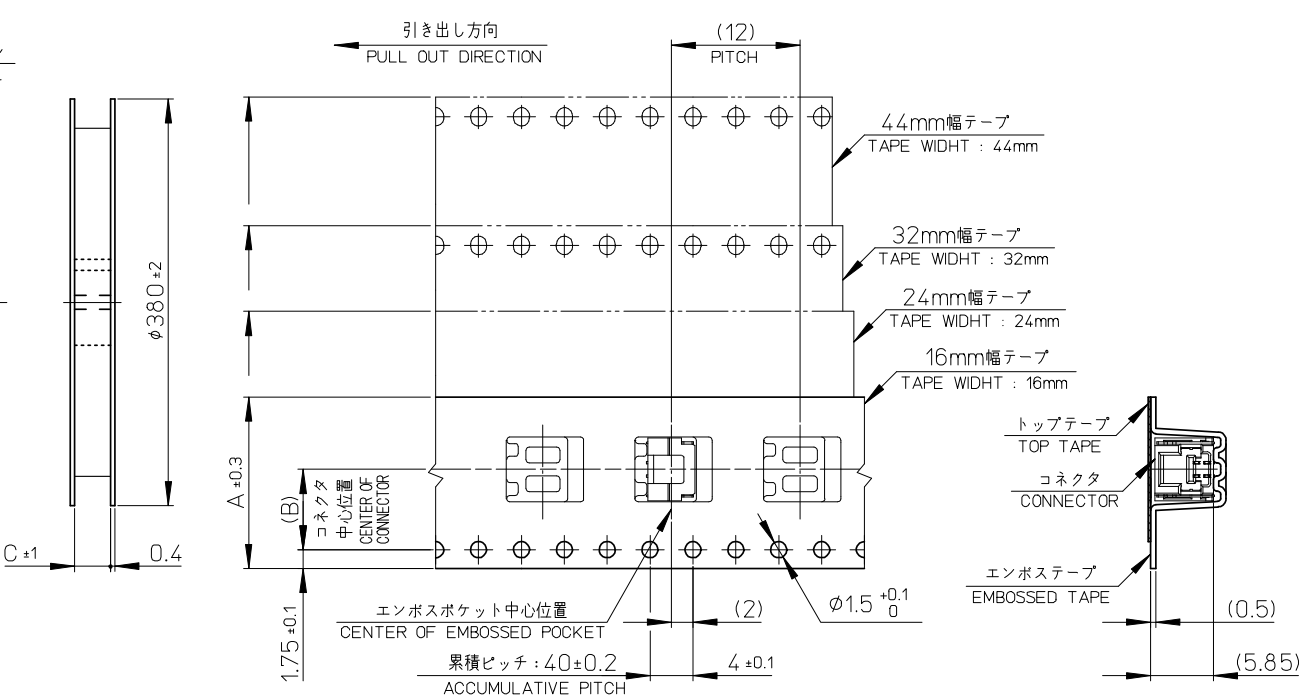
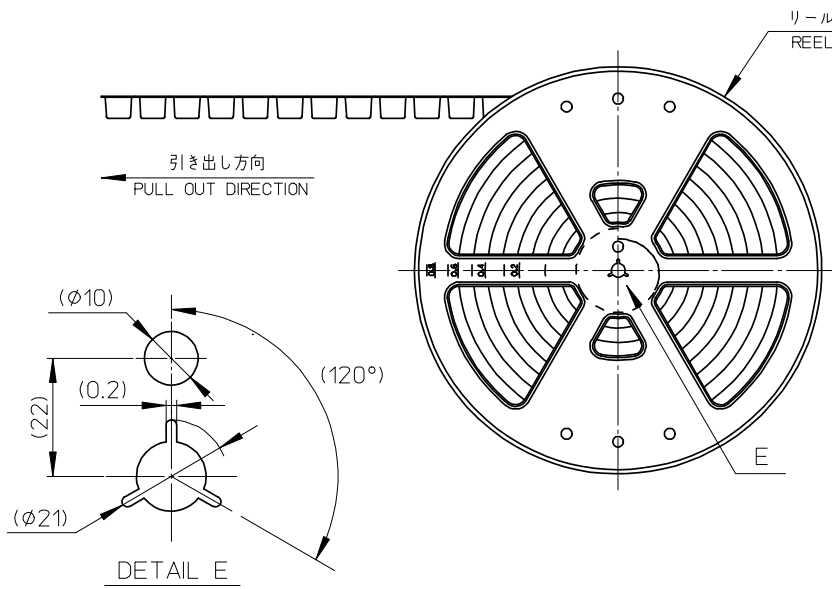

NOTES

- 製品詳細寸法については、SD-502386-001, -002 を参照下さい。
PLEASE REFER TO SD-502386-001, -002 FOR THE DETAILED DIMENSION OF THE CONNECTOR.
- 梱包数量 : 1200個
NUMBER OF CONNECTIONS : 1200 PIECES/REEL.
- リードテープ長さ
LEAD TAPE LENGTH

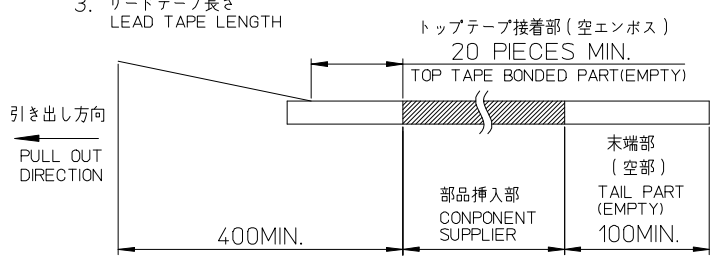

- 材料
MATERIAL
キャリアテープ : ポリスチレン
CARRIER TAPE : POLYSTYRENE
トップテープ : ポリエステル, ポリエチレン, ポリエチレンテレフタレート
TOP TAPE : POLYESTER, POLYETHYLENE, POLYETHYLENE TEREPHTHALATE
リール : ポリスチレン <リサイクル材を含む>
REEL : POLYSTYRENE <RECYCLE MATERIAL CONTAINED>
- ELV 及び RoHS 適合品
ELV AND RoHS COMPLIANT

45.5	20.2	44	—	—	502386-1509	502386-1570	502386-**7*	15	
45.5	20.2	44	—	—	502386-1409	502386-1470		14	
33.5	14.2	32	—	—	502386-1309	502386-1370		13	
33.5	14.2	32	—	—	502386-1209	502386-1270		12	
33.5	14.2	32	—	—	502386-1109	502386-1170		11	
33.5	14.2	32	—	—	502386-1009	502386-1070		10	
25.5	11.5	24	—	—	502386-0909	502386-0970		9	
25.5	11.5	24	—	—	502386-0809	502386-0870		8	
25.5	11.5	24	502386-0708	502386-0772	502386-0709	502386-0770		7	
25.5	11.5	24	502386-0608	502386-0672	502386-0609	502386-0670		6	
25.5	11.5	24	502386-0508	502386-0572	502386-0509	502386-0570	5		
25.5	11.5	24	502386-0408	502386-0472	502386-0409	502386-0470	4		
17.5	7.5	16	502386-0308	502386-0372	502386-0309	502386-0370	3		
17.5	7.5	16	502386-0208	502386-0272	502386-0209	502386-0270	2		
C	B	エンボステープ幅 A WIDTH OF TAPE	コネクタ CONNECTOR	製品番号 MATERIAL NO.	コネクタ CONNECTOR	製品番号 MATERIAL NO.	モデル番号 MODEL NO.	極数 (KT. NO.)	
WITH CAPTON TAPE				WITHOUT CAPTON TAPE					

REVISED EC NO: J2008-3866 DRW:KASETO 2008/05/12 CHK:KASAKAWA 2008/05/12 APPR: SICHIKAWA 2008/05/12	GENERAL TOLERANCES (UNLESS SPECIFIED)		DIMENSION STYLE MM ONLY		SCALE ---	DESIGN UNITS METRIC	THIRD ANGLE PROJECTION	
	10 UNDER	±0.2	DRAWN BY T. MIYAZAKI	DATE 2006/10/16	TITLE 1.25 W/B CONN. SINGLE R/A REC. EMBTP PKG			
	10 OVER 30 UNDER	±0.25	CHECKED BY K. ASAKAWA	DATE 2006/10/16	APPROVED BY YO. ITO			
	30 OVER	±0.3	MATERIAL NO. SEE TABLE		DOCUMENT NO. SD-502386-003		SHEET NO. 1 OF 1	
	ANGULAR ±3 °		DRAFT WHERE APPLICABLE MUST REMAIN WITHIN DIMENSIONS		THIS DRAWING CONTAINS INFORMATION THAT IS PROPRIETARY TO MOLEX INCORPORATED AND SHOULD NOT BE USED WITHOUT WRITTEN PERMISSION			