

Precision Monolithics Inc.

FEATURES

- Low Supply Current **55 μ A Max**
- Single-Supply Operation **+5V to +30V**
- Dual-Supply Operation **$\pm 2.5V$ to $\pm 15V$**
- Low Input Offset Voltage **250 μ V Max**
- Low Input Offset Voltage Drift **1.5 μ V/ $^{\circ}$ C Max**
- High Common-Mode Input Range ... **V- to V+ (-1.5V)**
- High CMRR and PSRR **100dB Min**
- High Open-Loop Gain **120dB Min**
- No External Components Required
- 741 Pinout and Nulling
- Available in Die Form

ORDERING INFORMATION [†]

| $T_A = +25^{\circ}\text{C}$ V_{OS} MAX (mV) | PACKAGE | | | OPERATING TEMPERATURE RANGE |
|-----------------------------------------------------|---------|-----------------|----------------------|-----------------------------------|
| | TO-99 | CERDIP 8-PIN | PLASTIC 8-PIN | |
| 250 | OP20BJ* | OP20BZ | - | MIL |
| 250 | OP20FJ | OP20FZ | - | IND |
| 250 | - | - | OP20FP | COM |
| 500 | - | OP20CZ | - | MIL |
| 500 | OP20GJ | OP20GZ | - | IND |
| 500 | - | - | OP20GP | COM |
| 1000 | OP20HJ | OP20HZ | OP20HS ^{††} | XIND |
| 1000 | - | - | OP20HP | XIND |

* For devices processed in total compliance to MIL-STD-883, add /883 after part number. Consult factory for 883 data sheet.

[†] Burn-in is available on commercial and industrial temperature range parts in cerDIP, plastic DIP, and TO-can packages. For ordering information, see 1990/91 Data Book, Section 2.

^{††} For availability and burn-in information on SO and PLCC packages, contact your local sales office.

GENERAL DESCRIPTION

The OP-20 is a monolithic micropower operational amplifier that can be operated from a single power supply of +5V to +30V, or from dual supplies of $\pm 2.5V$ to $\pm 15V$. The input voltage range extends to the negative rail, therefore input signals down to zero volts can be accommodated when operating from a single supply.

Precision performance in high-gain applications is readily obtained when using the OP-20. The B/F grade features a maximum input offset voltage of 250 μ V, minimum CMRR of 95dB, and open-loop gain of over 500,000. Quiescent supply current is a maximum of only 55 μ A at $\pm 2.5V$ or 80 μ A at $\pm 15V$. The low input offset, high gain, and low power consumption brings precision performance to portable instruments, satellites, missile control systems, and many other battery-powered applications.

PIN CONNECTIONS

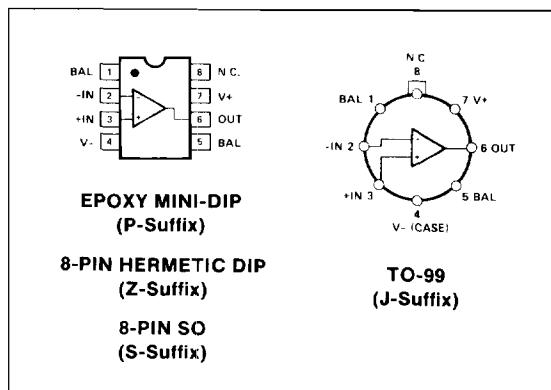

SIMPLIFIED SCHEMATIC

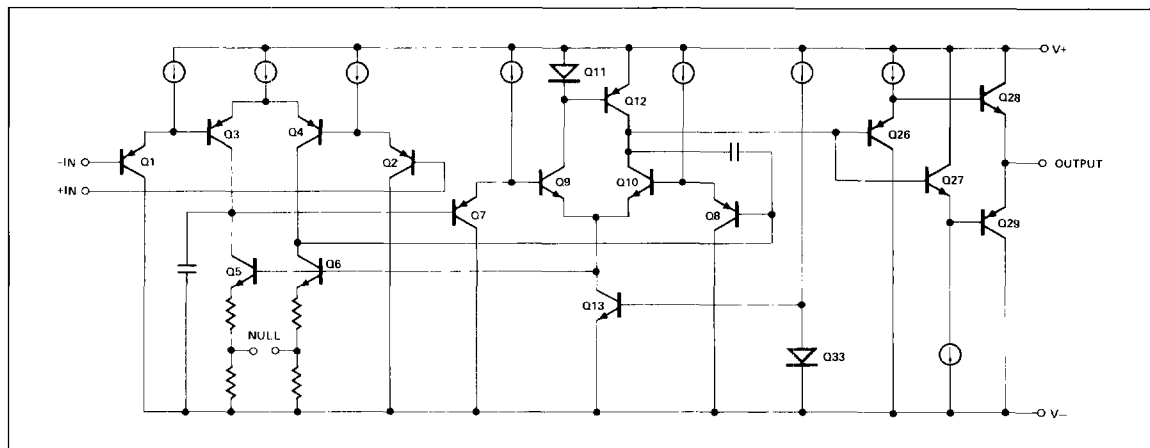

ABSOLUTE MAXIMUM RATINGS (Note 1)

| | |
|--------------------------------------------------|-----------------|
| Supply Voltage | ±18V |
| Differential Input Voltage | ±30V |
| Input Voltage | Supply Voltage |
| Output Short-Circuit Duration | Indefinite |
| Storage Temperature Range | |
| J and Z Packages | -65°C to +150°C |
| P Package | -65°C to +125°C |
| Operating Temperature Range | |
| OP-20B, OP-20C (J, Z) | -55°C to +125°C |
| OP-20F, OP-20G (J, Z) | -25°C to +85°C |
| OP-20H (S, P, J, Z) | -40°C to +85°C |
| OP-20FP, OP-20GP | 0°C to +70°C |
| Lead Temperature Range (Soldering, 60 sec) | 300°C |
| Junction Temperature | -65°C to +150°C |

| PACKAGE TYPE | θ_{JA} (NOTE 2) | θ_{JC} | UNITS |
|------------------------|------------------------|---------------|-------|
| TO-99 (J) | 150 | 18 | °C/W |
| 8-Pin Hermetic DIP (Z) | 148 | 16 | °C/W |
| 8-Pin Plastic DIP (P) | 103 | 43 | °C/W |
| 8-Pin SO (S) | 158 | 43 | °C/W |

NOTES:

1. Absolute maximum ratings apply to both DICE and packaged parts, unless otherwise noted.
2. θ_{JA} is specified for worst case mounting conditions, i.e., θ_{JA} is specified for device in socket for TO, CerDIP and P-DIP packages; θ_{JA} is specified for device soldered to printed circuit board for SO package.

ELECTRICAL CHARACTERISTICS at $V_S = \pm 2.5V$ to $\pm 15V$, $T_A = +25^\circ C$, unless otherwise noted.

| PARAMETER | SYMBOL | CONDITIONS | OP-20B/F | | | OP-20C/G | | | OP-20H | | | UNITS |
|------------------------------|----------|--------------------------------------------------------------------------|----------|------|-----|----------|------|-----|---------|------|------|------------|
| | | | MIN | TYP | MAX | MIN | TYP | MAX | MIN | TYP | MAX | |
| Input Offset Voltage | V_{OS} | $V_S = \pm 15V$ | — | 55 | 250 | — | 150 | 500 | — | 300 | 1000 | μV |
| Input Offset Current | I_{OS} | $V_{CM} = 0$ | — | 0.15 | 1.5 | — | 0.2 | 2.5 | — | 0.3 | 4.0 | nA |
| Input Bias Current | I_B | $V_{CM} = 0$ | — | 12 | 25 | — | 14 | 30 | — | 16 | 40 | nA |
| Input Voltage Range | IVR | $V_+ = +5V$, $V_- = 0V$ $V_S = \pm 15V$ | 0/3.5 | — | — | 0/3.5 | — | — | 0/3.5 | — | — | V |
| Common-Mode Rejection Ratio | CMRR | $V_+ = +5V$, $V_- = 0V$ $0V \leq V_{CM} \leq 3.5V$ | 95 | 105 | — | 90 | 95 | — | 85 | 90 | — | dB |
| | | $V_S = \pm 15V$ $-15V \leq V_{CM} \leq 13.5V$ | 100 | 110 | — | 94 | 105 | — | 90 | 100 | — | |
| Power Supply Rejection Ratio | PSRR | $V_S = \pm 2.5V$ to $\pm 15V$ and $V_- = 0V$, $V_+ = 5V$ to $30V$ | — | 4 | 6 | — | 6 | 10 | — | 10 | 32 | $\mu V/V$ |
| Large-Signal Voltage Gain | A_{VO} | $V_+ = +5V$, $V_- = 0V$ $1V \leq V_O \leq 3.5V$ | 300 | 500 | — | 200 | 500 | — | — | 500 | — | V/mV |
| | | $V_S = \pm 15V$, $V_O = \pm 10V$ $R_L = 25k\Omega$ | 1000 | 2000 | — | 800 | 2000 | — | 500 | 1000 | — | |
| Output Voltage Swing | V_O | $V_+ = 5V$, $V_- = 0V$ $R_L = 10k\Omega$ | 0.6/4.1 | — | — | 0.7/4.1 | — | — | 0.8/4.0 | — | — | V |
| | | $V_S = \pm 15V$, $R_L = 25k\Omega$ | ±14.1 | — | — | ±14.1 | — | — | ±14.0 | — | — | |
| Closed-Loop Bandwidth | BW | $A_{VCL} = +1.0$, $R_L = 10k\Omega$ | — | 100 | — | — | 100 | — | — | 100 | — | kHz |
| Slew Rate | SR | $V_S = \pm 15V$ $R_L = 25k\Omega$ | — | 0.05 | — | — | 0.05 | — | — | 0.05 | — | V/ μs |
| Supply Current | I_{SY} | $V_S = \pm 2.5V$, No Load | — | 40 | 55 | — | 44 | 63 | — | 45 | 70 | μA |
| | | $V_S = \pm 15V$, No Load | — | 55 | 80 | — | 57 | 85 | — | 60 | 95 | |

ELECTRICAL CHARACTERISTICS at $V_S = \pm 2.5V$ to $\pm 15V$, $-55^\circ C \leq T_A \leq +125^\circ C$ for OP-20BJ/BZ and OP-20CZ, $-25^\circ C \leq T_A \leq +85^\circ C$ for OP-20FJ/FZ and OP-20GJ/GZ, and $0^\circ C \leq T_A \leq +70^\circ C$ for OP-20FP, OP-20GP, and $-40^\circ C \leq T_A \leq +85^\circ C$ for OP-20HZ, OP-20HJ, and OP-20HP/HS, unless otherwise noted.

| PARAMETER | SYMBOL | CONDITIONS | OP-20B/F | | | OP-20C/G | | | OP-20H | | | UNITS |
|---------------------------------------------|------------|---------------------------------------------------------------------------------------------------------|-----------------------|------------|----------|-----------------------|-----------|-----------|-----------------------|-----------|-----------|------------------|
| | | | MIN | TYP | MAX | MIN | TYP | MAX | MIN | TYP | MAX | |
| Average Input Offset Voltage Drift (Note 1) | TCV_{OS} | Unnull'd | — | 0.75 | 1.5 | — | 1.0 | 3.0 | — | 1.5 | 7.0 | $\mu V/^\circ C$ |
| Input Offset Voltage | V_{OS} | $V_S = \pm 15V$ | — | 155 | 400 | — | 250 | 800 | — | 500 | 1700 | μV |
| Input Offset Current | I_{OS} | $V_{CM} = 0$ | — | 0.5 | 2.5 | — | 1.0 | 3.5 | — | 1.5 | 5.0 | nA |
| Input Bias Current | I_B | $V_{CM} = 0$ | — | 12 | 27 | — | 14 | 33 | — | 16 | 45 | nA |
| Input Voltage Range | IVR | $V_+ = +5V, V_- = 0V$ $V_S = \pm 15V$ | 0/3.2 -15/13.2 | — | — | 0/3.2 -15/13.2 | — | — | 0/3.2 -15/13.2 | — | — | V |
| Common-Mode Rejection Ratio | CMRR | $V_+ = +5V, V_- = 0V$ $0V \leq V_{CM} \leq 3.2V$ $V_S = \pm 15V$ $-15V \leq V_{CM} \leq 13.2V$ | 90 96 | 100 110 | — | 85 90 | 90 105 | — | 80 85 | 85 100 | — | dB |
| Power Supply Rejection Ratio | PSRR | $V_S = \pm 2.5V$ to $\pm 15V$ $V_- = 0V$, $V_+ = 5V$ to $30V$ | — | 4 | 10 | — | 6 | 18 | — | 10 | 32 | $\mu V/V$ |
| Large-Signal Voltage Gain | A_{VO} | $V_S = \pm 15V, V_O = \pm 10V$ $R_L = 50k\Omega$ | 500 | 700 | — | 400 | 600 | — | 250 | 400 | — | V/mV |
| Output Voltage Swing | V_O | $V_+ = 5V, V_- = 0V$, $R_L = 50k\Omega$ $V_S = \pm 15V$, $R_L = 50k\Omega$ | 0.8/4.0 ± 14.0 | — | — | 0.9/3.9 ± 13.9 | — | — | 1.0/3.8 ± 13.9 | — | — | V |
| Supply Current | I_{SY} | $V_S = \pm 2.5V$, No Load or $+5V, 0V$ $V_S = \pm 15V$, No Load | — | 50 64 | 65 95 | — | 53 68 | 75 100 | — | 55 72 | 85 115 | μA |

NOTE:

- Sample tested.

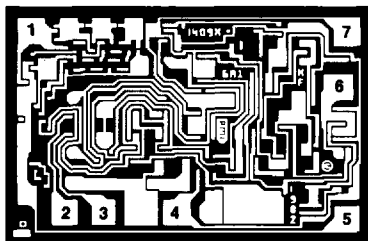

DICE CHARACTERISTICS

DIE SIZE 0.069 × 0.046 inch, 3174 sq. mils
(1.75 × 1.17 mm, 2.05 sq. mm)

1. BALANCE
2. INVERTING INPUT
3. NONINVERTING INPUT
4. V⁻
5. BALANCE
6. OUTPUT
7. V⁺

For additional DICE ordering information,
refer to 1990/91 Data Book, Section 2.

WAFER TEST LIMITS at $V_S = \pm 15V$, $T_A = 25^\circ C$, unless otherwise noted.

| PARAMETER | SYMBOL | CONDITIONS | OP-20N LIMIT | OP-20G LIMIT | OP-20GR LIMIT | UNITS |
|---------------------------------|----------|-------------------------------------------------------------------------------------------------------------------------------|-----------------------|-----------------------|-----------------------|---------------|
| Input Offset Voltage | V_{OS} | | 300 | 600 | 1000 | μV MAX |
| Input Offset Current | I_{OS} | | 1.5 | 2.5 | 4.0 | nA MAX |
| Input Bias Current | I_B | | 25 | 30 | 40 | nA MAX |
| Input Voltage Range | IVR | V ⁺ = +5V, V ⁻ = 0V $V_S = \pm 15V$ | 0/3.5 -15/13.5 | 0/3.5 -15/13.5 | 0/3.5 -15/13.5 | V MIN |
| Common-Mode Rejection Ratio | CMRR | V ⁺ = +5V, V ⁻ = 0V, $0V \leq V_{CM} \leq +3.5V$ $V_S = \pm 15V$, $-15V \leq V_{CM} \leq \pm 13.5V$ | 95 100 | 90 94 | 85 90 | dB MIN |
| Power Supply Rejection Ratio | PSRR | $V_S = \pm 2.5V$ to $\pm 15V$ V ⁻ = 0V, V ⁺ = +5V to +30V | 6 | 10 | 32 | $\mu V/V$ MAX |
| Large-Signal Voltage Gain | A_{VO} | $R_L = 25k\Omega$ $V_O = \pm 10V$ | 1000 | 800 | 500 | V/mV MIN |
| Output Voltage Swing | V_O | $R_L = 10k\Omega$, V ⁺ = +5V, V ⁻ = 0V $R_L = 25k\Omega$, $V_S = \pm 15V$ | 0.7/4.1 ± 14.1 | 0.8/4.1 ± 14.1 | 0.9/4.0 ± 14.0 | V MIN |
| Supply Current | I_{SY} | $V_S = \pm 2.5V$, No Load $V_S = \pm 15V$, No Load | 55 80 | 63 85 | 70 95 | μA MAX |

NOTE:

Electrical tests are performed at wafer probe to the limits shown. Due to variations in assembly methods and normal yield loss, yield after packaging is not guaranteed for standard product dice. Consult factory to negotiate specifications based on dice lot qualification through sample lot assembly and testing.

TYPICAL ELECTRICAL CHARACTERISTICS at $V_S = \pm 15V$, $T_A = +25^\circ C$, unless otherwise noted.

| PARAMETER | SYMBOL | CONDITIONS | OP-20N TYPICAL | OP-20G TYPICAL | OP-20GR TYPICAL | UNITS |
|---------------------------------------|---------------------------|---------------------------------------|-------------------|-------------------|--------------------|------------------|
| Average Input Offset Voltage Drift | TCV_{OS} TCV_{OSn} | Unnulled Nulled, $R_P = 10k\Omega$ | 1.0 1.0 | 1.5 1.5 | 2.5 2.5 | $\mu V/^\circ C$ |
| Large-Signal Voltage Gain | A_{VO} | $R_L = 25k\Omega$ | 2000 | 2000 | 1000 | V/mV |

TYPICAL PERFORMANCE CHARACTERISTICS

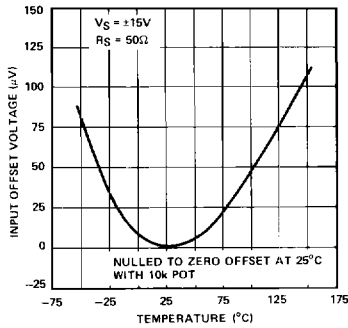
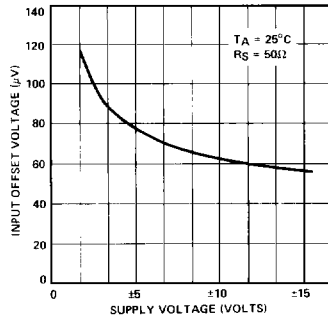
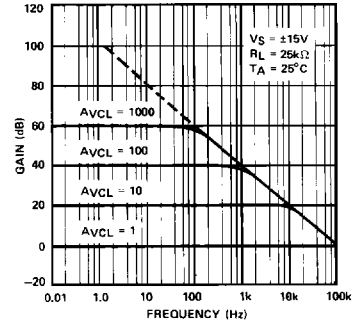
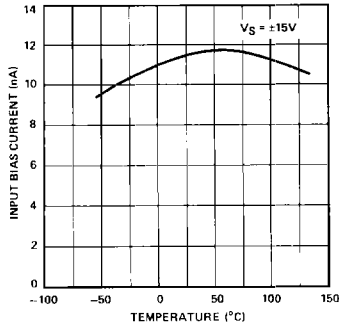
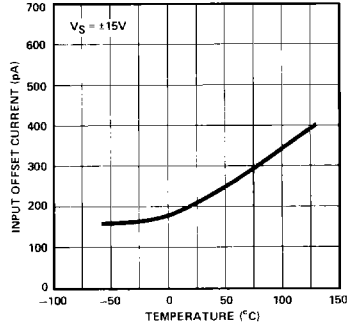
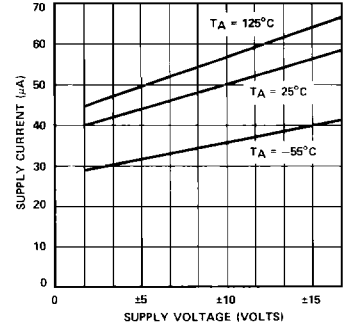
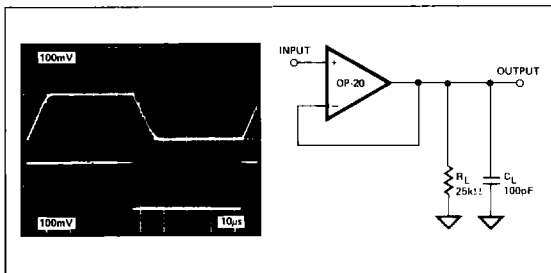
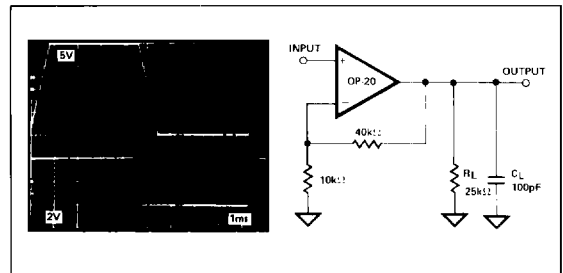
TRIMMED OFFSET VOLTAGE vs TEMPERATURE

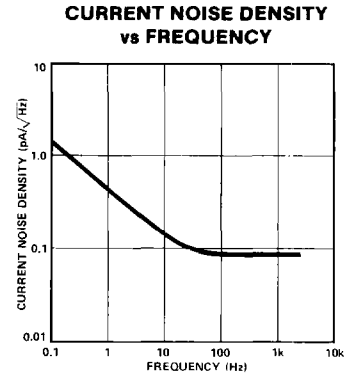
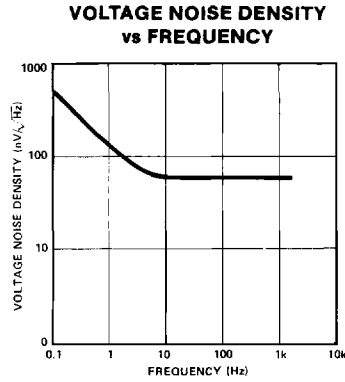
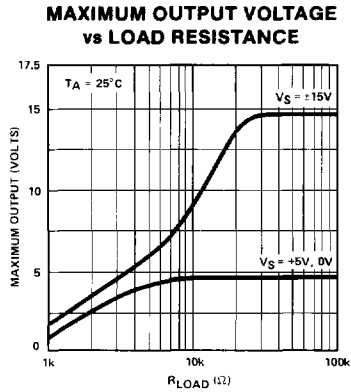
INPUT OFFSET VOLTAGE vs POWER SUPPLY VOLTAGE

CLOSED-LOOP GAIN vs FREQUENCY

INPUT BIAS CURRENT vs TEMPERATURE

INPUT OFFSET CURRENT vs TEMPERATURE

SUPPLY CURRENT vs SUPPLY VOLTAGE

SMALL-SIGNAL TRANSIENT RESPONSE

LARGE-SIGNAL TRANSIENT RESPONSE

TYPICAL PERFORMANCE CHARACTERISTICS

TYPICAL APPLICATIONS
TEMPERATURE SENSOR
