



PA4835

CMOS IC

STEREO 2.8W AUDIO POWER AMPLIFIER WITH DC VOLUME CONTROL AND SELECTABLE GAIN

DESCRIPTION

The UTC **PA4835** is a monolithic integrated circuit and designed to provide DC volume control , and a stereo bridged audio power amplifiers capable of producing 2.8W into 3Ω at 10% THD+N and 2.2W into 3Ω at 1.0% THD+N.. UTC **PA4835** incorporated a DC volume control, stereo bridge-tied and single-ended audio power amplifiers, stereo docking outputs, and a selectable gain control, makes it optimally suitable for notebook PC, multimedia monitors, and other portable applications.

FEATURES

- *Operating Voltage : 3.3V ~ 5V
- *Stereo switchable bridged/single-ended power amplifiers
- *DC Volume Control Interface , 0dB ~ -105dB
- *Low Supply Current (13mA at stereo BTL)
- *Low Shutdown Current(0.7 μ A, typ)
- *Bridge-Tied Load (BTL) or Single-Ended-(SE) Modes Operation
- *Output Power at 1% THD+N , V_{DD}=5V
 - 2.2W/Ch (typ) into a 3 Ω Load
 - 2.0W/Ch (typ) into a 4 Ω Load
 - 1.2W/Ch (typ) into a 8 Ω Load
- *Output Power at 10% THD+N , V_{DD}=5V
 - 2.8W/Ch (typ) into a 3 Ω Load
 - 2.3W/Ch (typ) into a 4 Ω Load
 - 1.5W/Ch (typ) into a 8 Ω Load
- *Single-ended mode:
 - 1.0% THD+N at 95mW/Ch (typ) into 32Ω
- *System Beep Detect
- *Thermal shutdown protection circuitry
- *High supply voltage ripple rejection
- *Low Crossover Distortion

ORDERING INFORMATION

Ordering Number			Package	Packing
Normal	Lead Free	Halogen Free		
PA4835-P28-R	PA4835L-P28-R	PA4835G-P28-R	TSSOP-28	Tape Reel
PA4835-P28-T	PA4835L-P28-T	PA4835G-P28-T	TSSOP-28	Tube
PA4835-N28-R	PA4835L-N28-R	PA4835G-N28-R	HTSSOP-28	Tape Reel
PA4835-N28-T	PA4835L-N28-T	PA4835G-N28-T	HTSSOP-28	Tube

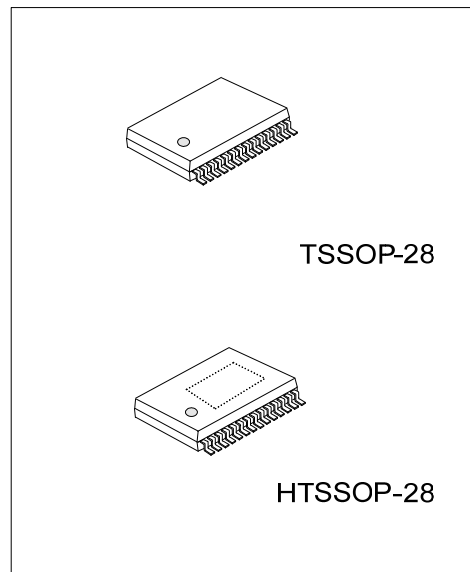

Lead-free: PA4835L
Halogen-free: PA4835G

ORDERING INFORMATION(Cont.)

<p>PA4835L-P28-R</p> <p>(1) Packing Type (2) Package Type (3) Lead Plating</p>	<p>(1) R: Tape Reel, T: Tube (2) P28: TSSOP-28, N28: HTSSOP-28 (3) G: Halogen Free, L: Lead Free, Blank: Pb/Sn</p>
--	--

PIN CONFIGURATION

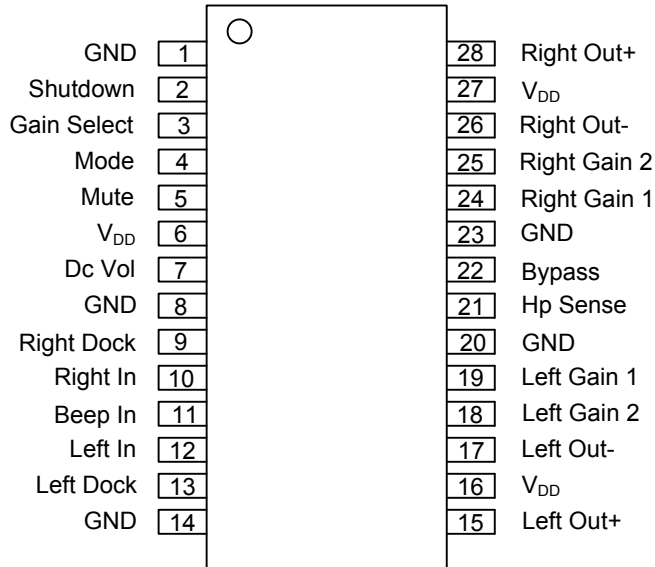

PIN DESCRIPTION

PIN NO.	PIN NAME	I/O	DESCRIPTION
1,8,14,20,23	GND		Ground connection for circuitry.
2	Shutdown	I	Shutdown mode control signal input, place entire IC in shutdown mode when held high, I _{DD} =0.7μA
3	Gain Select	I	Gain select input pin
4	Mode	I	Mode select input pin
5	Mute	I	Mute control input pin
6,16,27	V _{DD}		Supply voltage input pin
7	Dc Vol	I	Volume control function input pin
9	Right Dock	O	Right docking output pin
10	Right In	I	Right channel audio input pin
11	Beep In	I	Beep signal input pin
12	Left In	I	Left channel audio input pin
13	Left Dock	O	Right docking output pin
15	Left Out +	O	Left channel positive output pin
17	Left Out -	O	Left channel negative output pin
18	Left Gain 2		Connect pin 2 of the external gain setting resistor for left channel
19	Left Gain 1		Connect pin 1 of the external gain setting resistor for left channel
21	HP Sense	I	Headphone sense control pin
22	Bypass		Bypass pin
24	Right Gain 1		Connect pin 1 of the external gain setting resistor for right channel
25	Right Gain 2		Connect pin 2 of the external gain setting resistor for right channel
26	Right Out -	O	Right channel negative output pin
28	Right Out +	O	Right channel positive output pin

■ BLOCK DIAGRAM

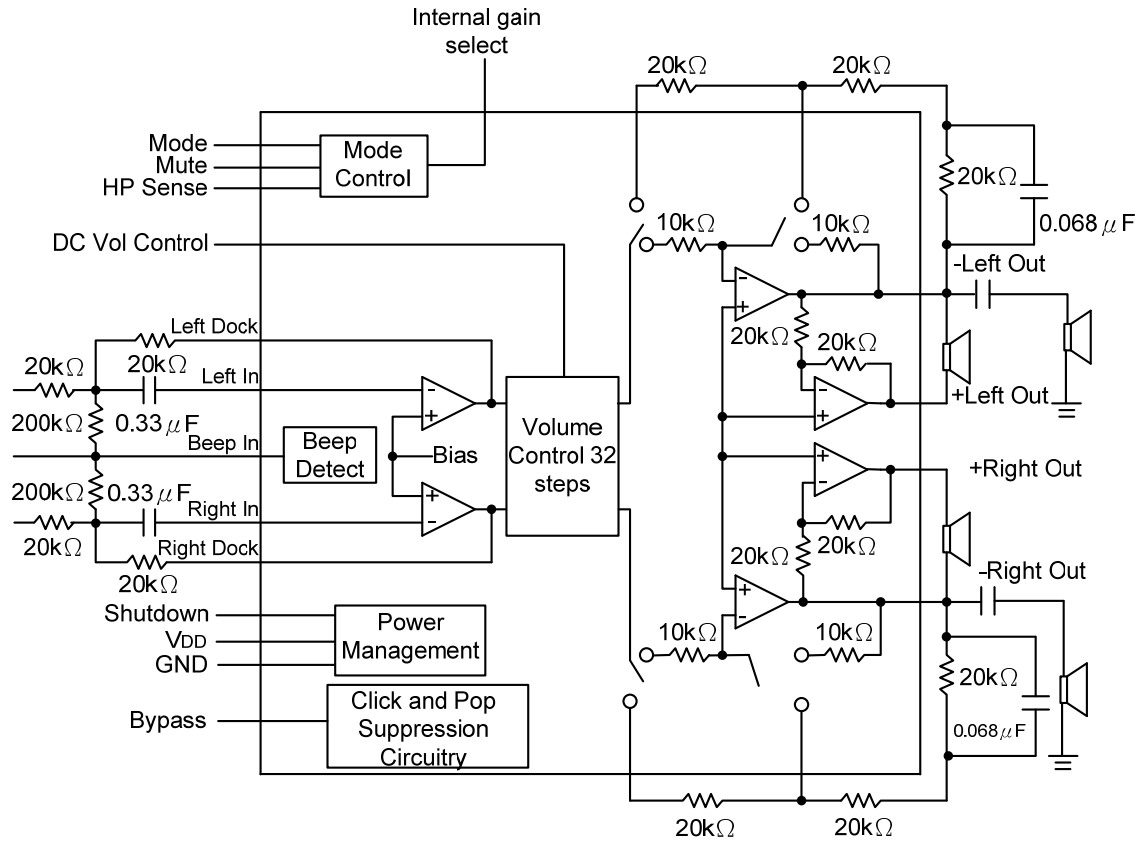

■ ABSOLUTE MAXIMUM RATINGS

PARAMETER	SYMBOL	RATINGS	UNIT
Supply Voltage	V_{DD}	6	V
Operating Ambient Temperature	T_{OPR}	0 ~ +70	°C
Junction Temperature	T_J	+125	°C
Storage Temperature	T_{STG}	-40 ~ +150	°C

Note: 1. Absolute maximum ratings are stress ratings only and functional device operation is not implied. The device could be damaged beyond Absolute maximum ratings.

2. The device is guaranteed to meet performance specifications within 0°C~70°C operating temperature range and assured by design from -20°C~85°C.

■ THERMAL CHARACTERISTICS

PARAMETER	SYMBOL	RATINGS	UNIT	
Thermal Resistance	TSSOP-28	θ_{JA}	105	°C/W
		θ_{JC}	15	
	HTSSOP-28	θ_{JA}	93	
		θ_{JC}	10	

Note: The θ_{JA} of HTSSOP-28 is given that exposed die attach pad is not soldered on PCB.

■ ELECTRICAL CHARACTERISTICS ($V_{DD}=5V$, $T_a=25^\circ C$, unless otherwise specified.)

PARAMETER	SYMBOL	TEST CONDITIONS	MIN	TYP	MAX	UNIT
ENTIRE IC						
Supply Voltage	V_{DD}		3.3		5.5	V
SE/BTL High Input Voltage	V_{IH}		4			V
SE/BTL Low Input Voltage	V_{IL}				0.8	V
Quiescent Power Supply Current	I_{DD}	$V_{IN}=0V$, $I_O=0A$		13	25	mA
Shutdown Current	I_{SHD}	$V_{PIN2}=V_{DD}$		0.7	2.0	µA
VOLUME ATTENUATORS						
Attenuator Range	C_{RANGE}	Gain with $V_{PIN7}=5V$			±0.5	dB
		Attenuation with $V_{PIN7}=0V$	-90	-105		dB
Mute Attenuation	A_M	$V_{PIN5}=5V$, BTL Mode	-88			dB
		$V_{PIN5}=5V$, SE Mode	-88			dB
BTL MODE OPERATION						
Output Offset Voltage	V_{OS}	$V_{IN}=0V$		5		mV
Output Noise Voltage	V_N	$R_L=8\Omega$, A-Wtd Filter		30		µV
Output Power	THD=1%, f = 1kHz	P_O	$R_L=3\Omega$		2.2	W
			$R_L=4\Omega$		2.0	
	THD=10%, f = 1kHz		$R_L=8\Omega$		1.2	
			$R_L=8\Omega$		1.5	
Total Harmonic Distortion + Noise	THD+N		$A_{VD}=2$, 20Hz < f < 20kHz		0.2	%
			$R_L=4\Omega$, $P_O=1W$		0.15	
			$R_L=8\Omega$, $P_O=1W$		0.1	
			$R_L=32\Omega$, $P_O=340mW$			
Power Supply Rejection Ratio	RSRR	$V_{RIPPLE}=200mV_{RMS}$, $R_L=8\Omega$ $C_B=2.2\mu F$, f = 120Hz		74		dB
Channel Separation	X_{TALK}	f = 1kHz, $C_B=2.2\mu F$		95		dB
Signal-to-Noise Ratio	SNR	$V_{DD}=5V$, $P_O=1.1W$, $R_L=8\Omega$ A-Wtd Filter		95		dB

■ ELECTRICAL CHARACTERISTICS(Cont.)

SE MODE OPERATION					
Output Offset Voltage	V_{OS}	$V_{IN}=0V$		5	mV
Output Noise Voltage	V_N	$R_L=1k\Omega$, A -Wtd Filter		40	μV
Output Power	P_O	THD=1%, $f=1kHz$, $R_L=32\Omega$ THD=10%, $f=1kHz$, $R_L=32\Omega$		95 100	mW
Total Harmonic Distortion plus Noise	THD+N	$A_V=1$, $V_{OUT}=1V_{RMS}$, $f=1kHz$ $R_L=1K\Omega$		0.01	%
		$P_O=75mW$, $R_L=32\Omega$, $A_V=1$ $f=1kHz$		0.005	
Power Supply Rejection Ratio	PSRR	$V_{RIPPLE}=200mV_{RMS}$, $f=120Hz$ $C_B=2.2\mu F$		58	dB
Channel Separation	X_{TALK}	$f=1kHz$, $C_B=2.2\mu F$		95	dB
Signal-to-Noise Ratio	SNR	$P_O=75mW$, $R_L=32\Omega$, A -Wtd Filter		102	dB

■ TRUTH TABLE FOR LOGIC INPUTS

MUTE	MODE	HP SENSE	DC VOL CONTROL	BRIDGED OUTPUT	SINGLE-ENDED
0	0	0	Fixed Level	Vol.Fixed	
0	0	1	Fixed Level	Muted	Vol.Fixed
0	1	0	Adjusted	Vol.Changed	
0	1	1	Adjusted	Muted	Vol.Changed
1	X	X		Muted	Muted

■ TYPICAL APPLICATION CIRCUIT

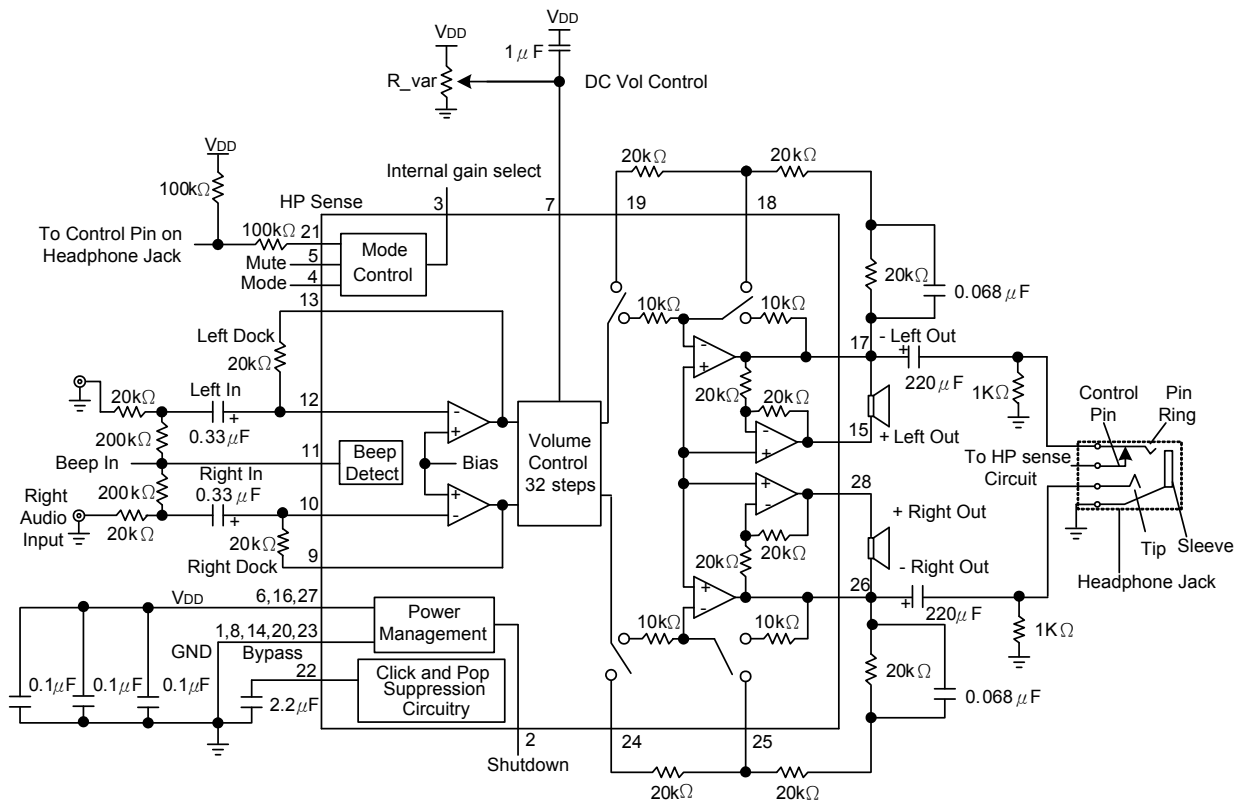

■ TYPICAL CHARACTERISTICS

For $V_{DD}=5V$, THD+N vs Frequency

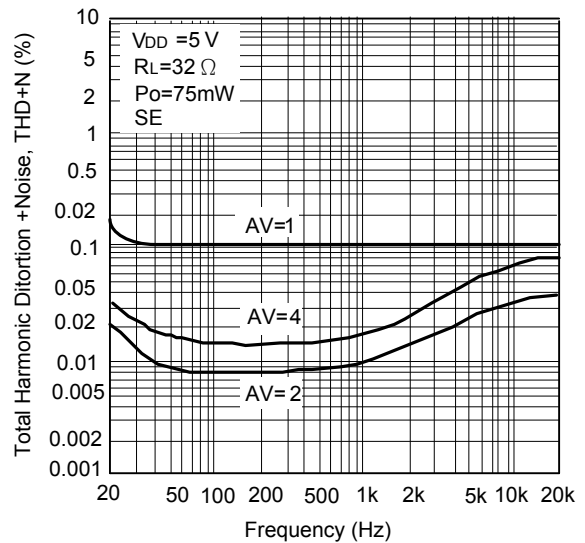
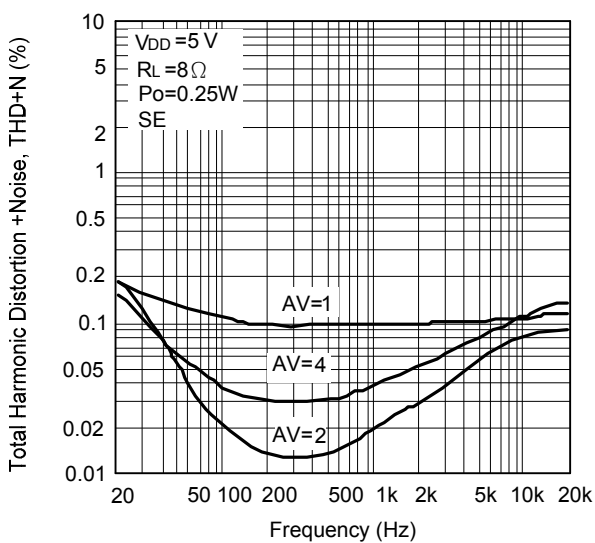
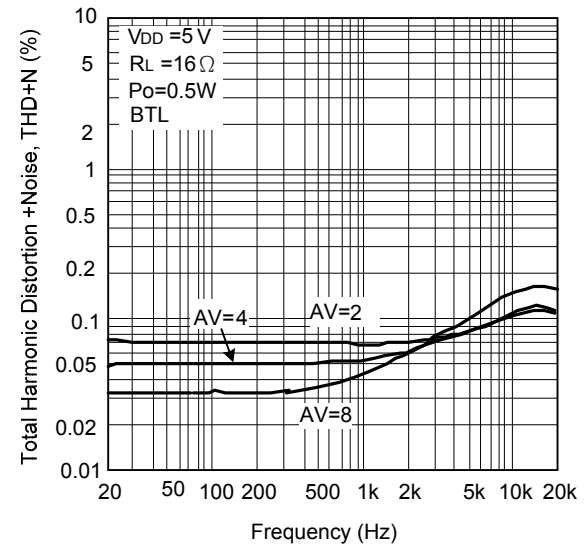
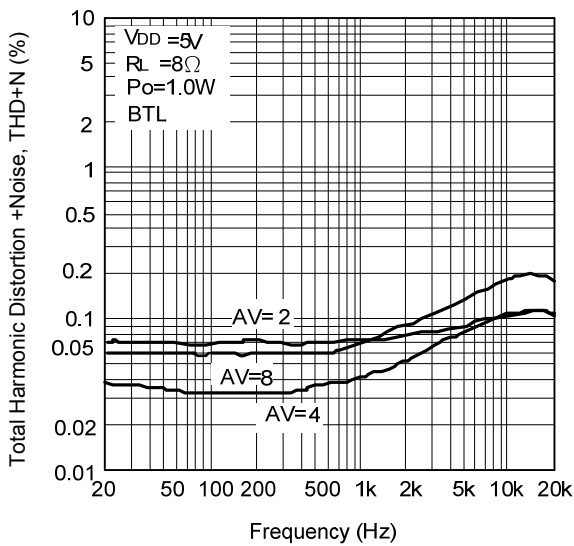
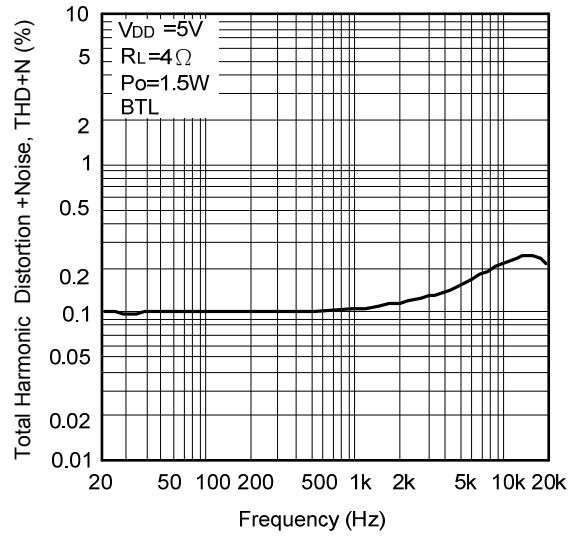
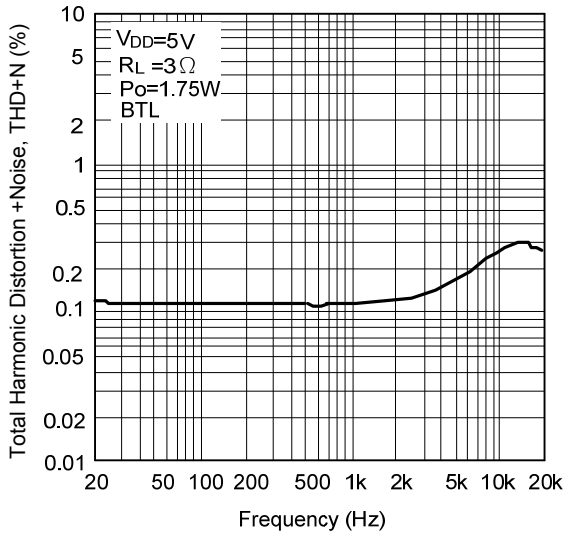

■ TYPICAL CHARACTERISTICS(cont.)

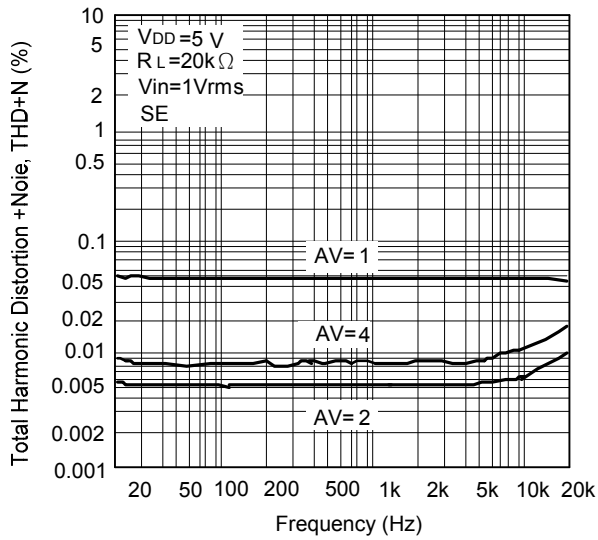

For $V_{DD}=3V$, THD+N vs Frequency

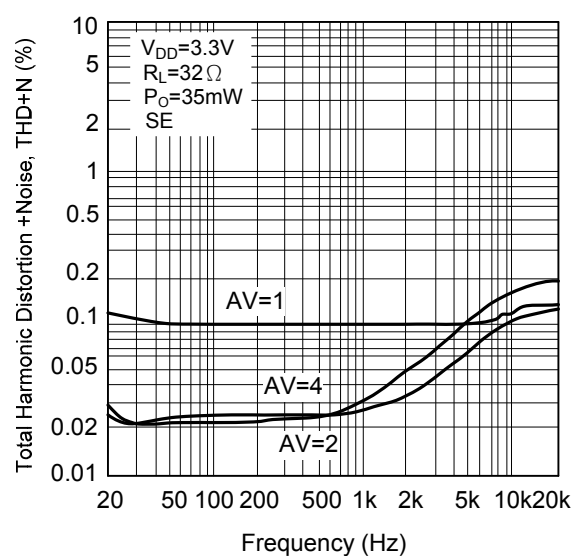
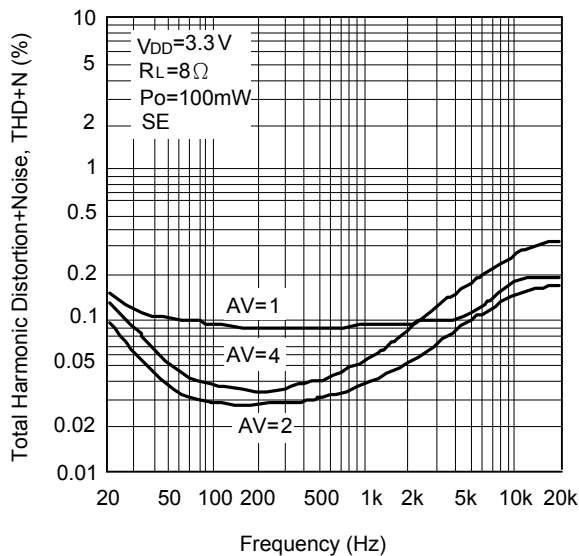
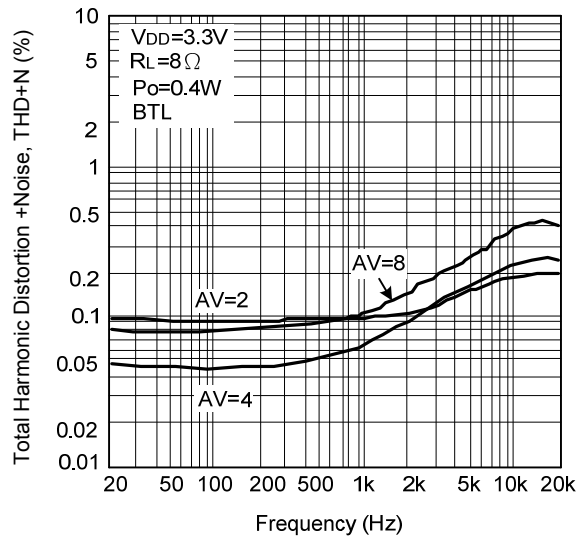
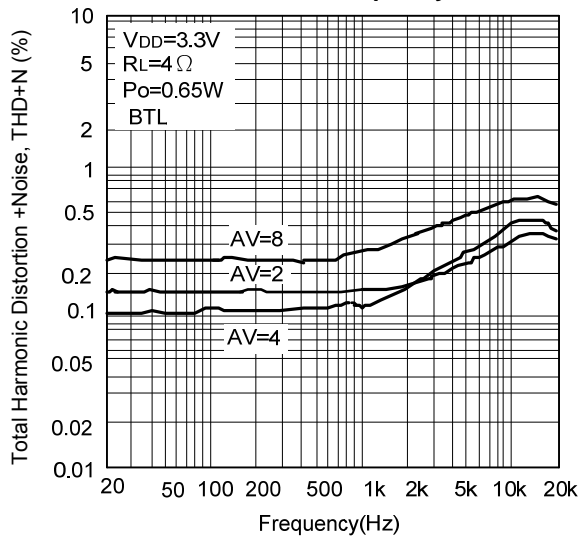

■ TYPICAL CHARACTERISTICS(cont.)

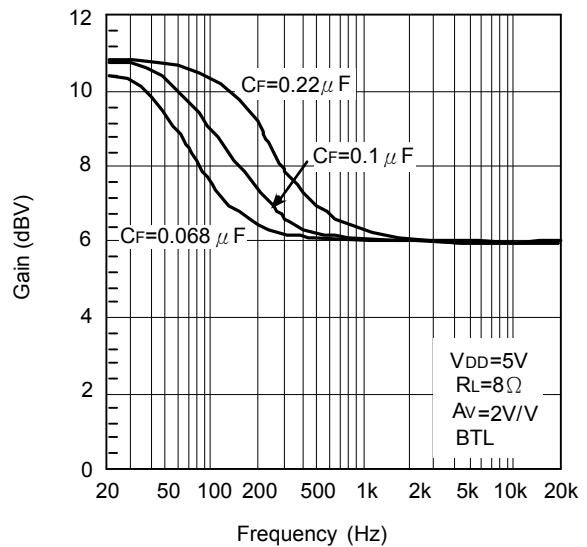
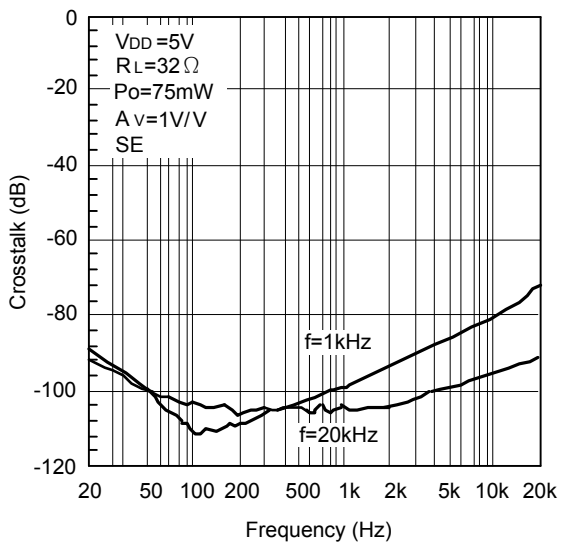
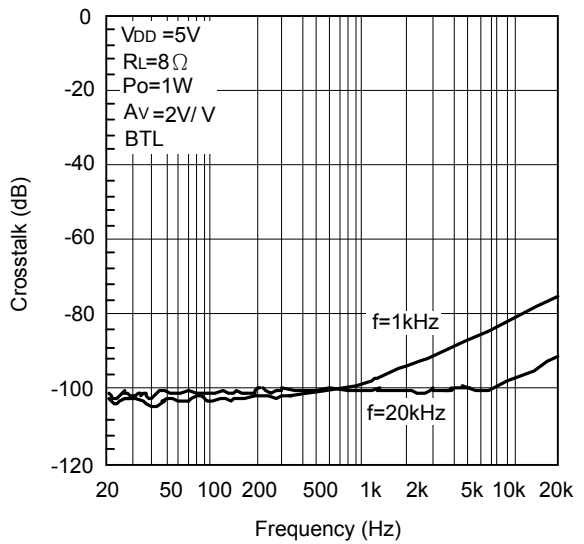
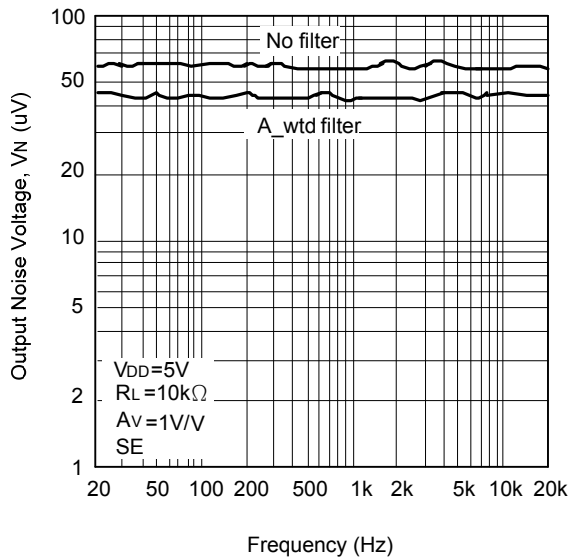
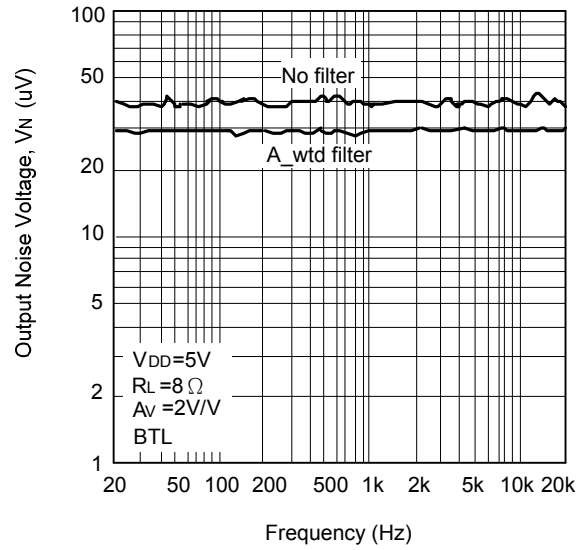
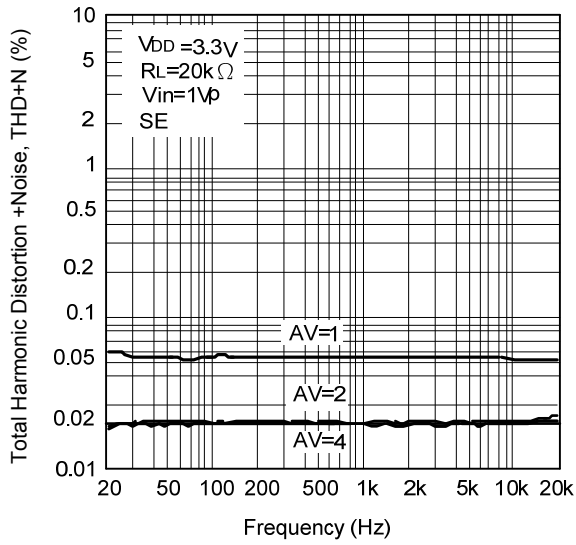

■ TYPICAL CHARACTERISTICS(cont.)

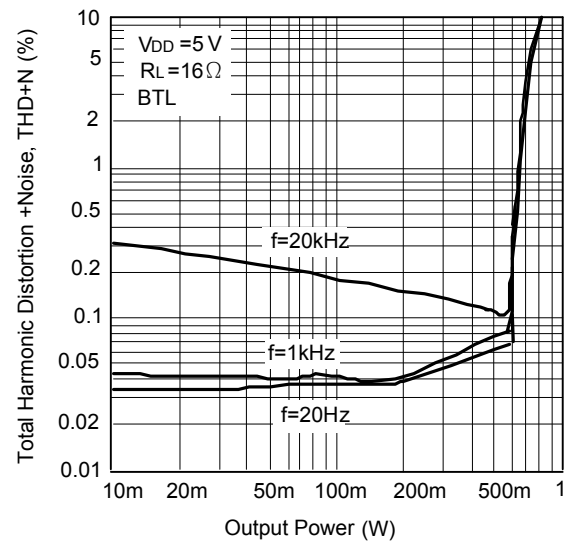
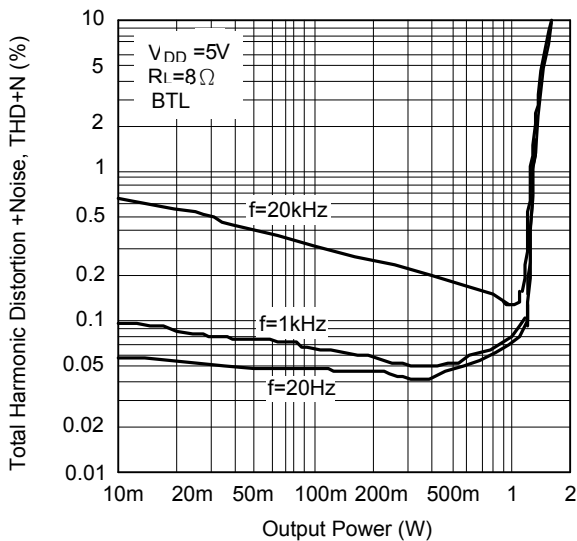
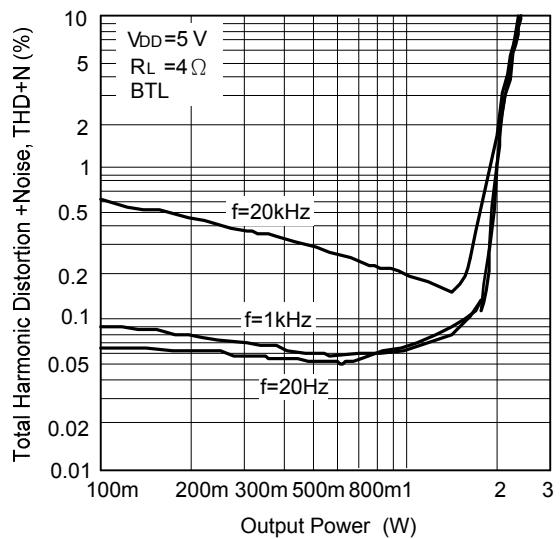
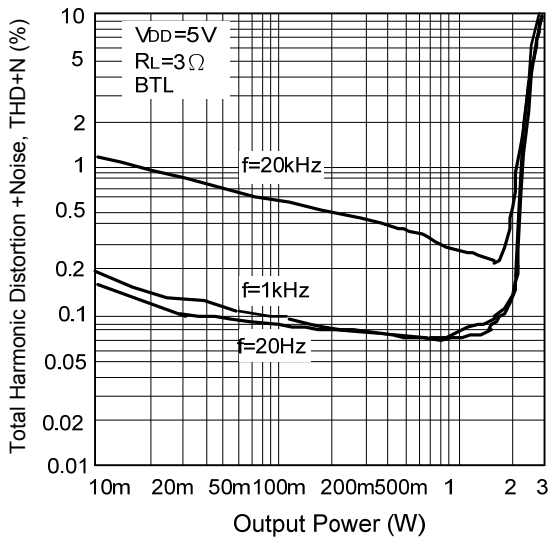
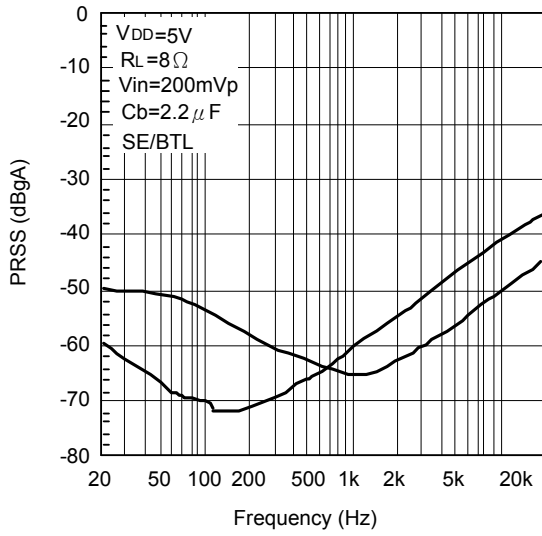

■ TYPICAL CHARACTERISTICS(cont.)

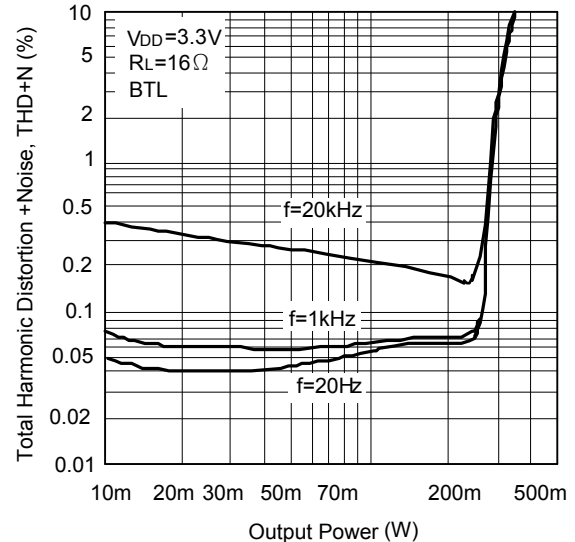
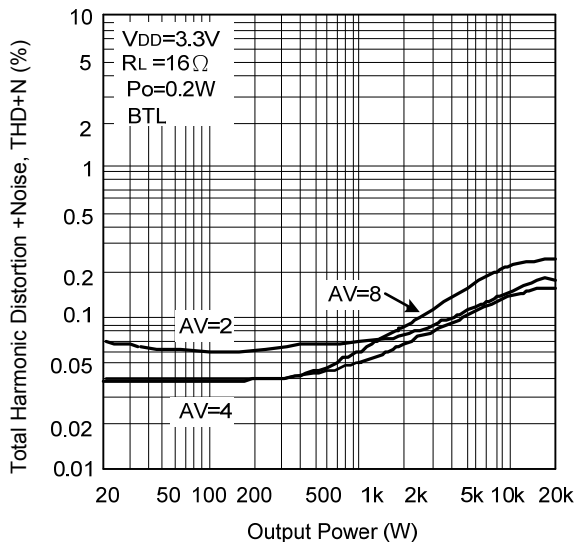
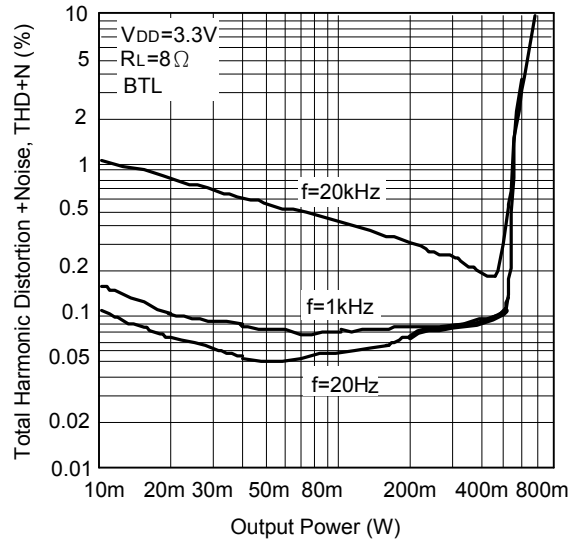
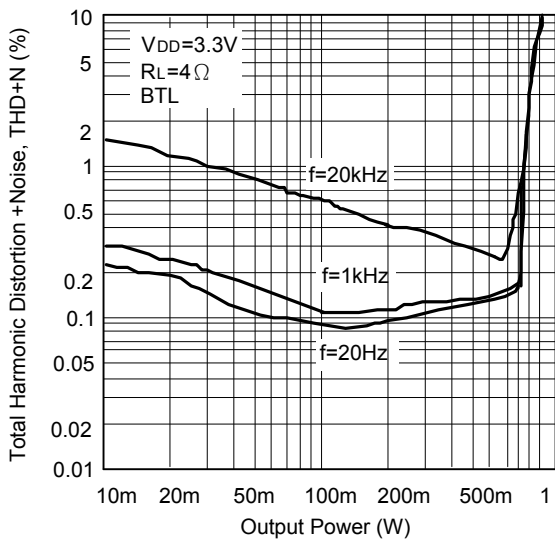
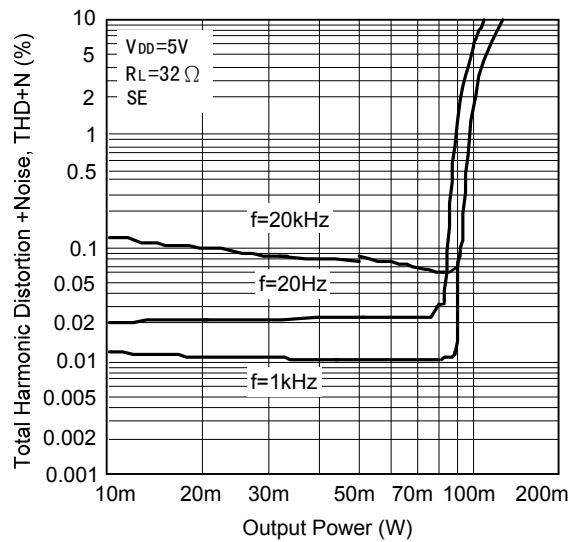
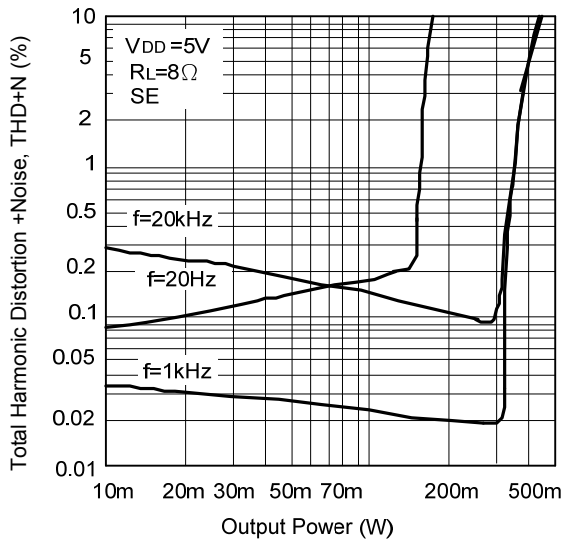

■ TYPICAL CHARACTERISTICS(cont.)

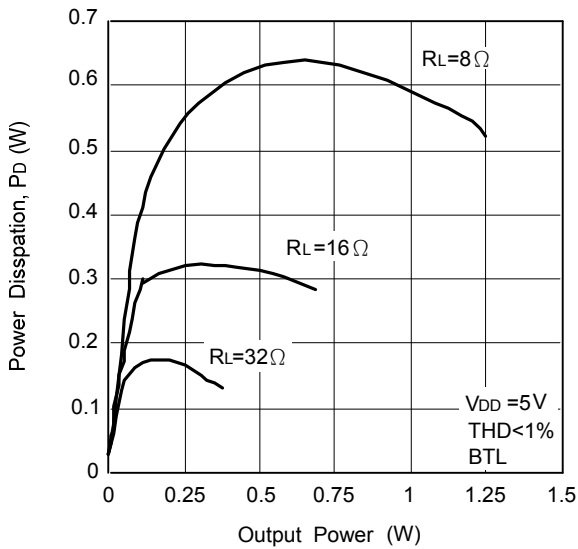
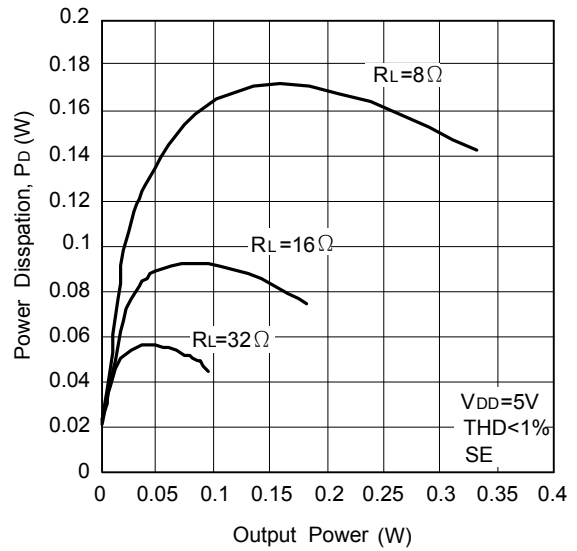
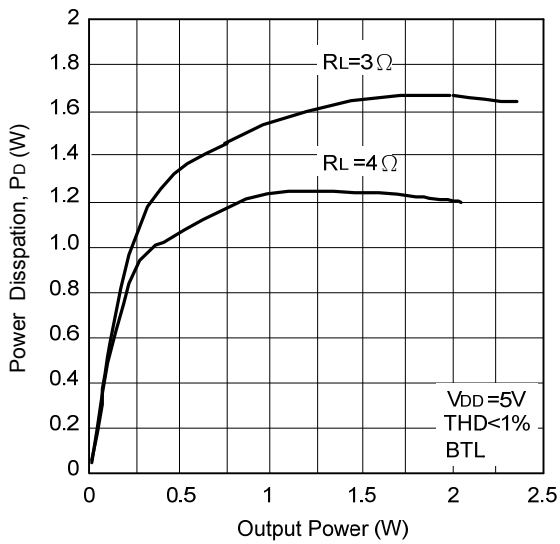
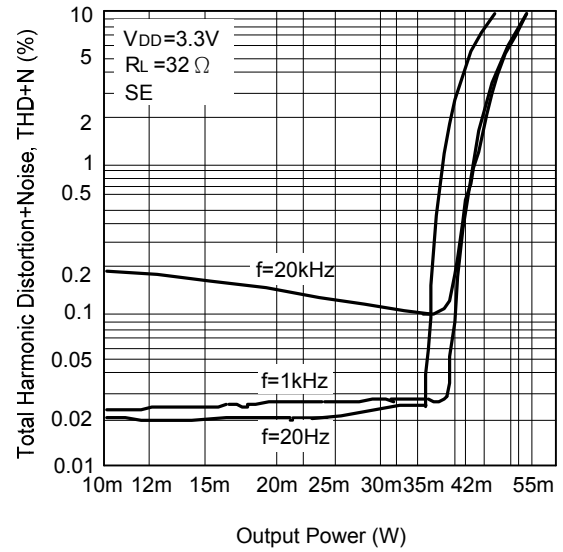
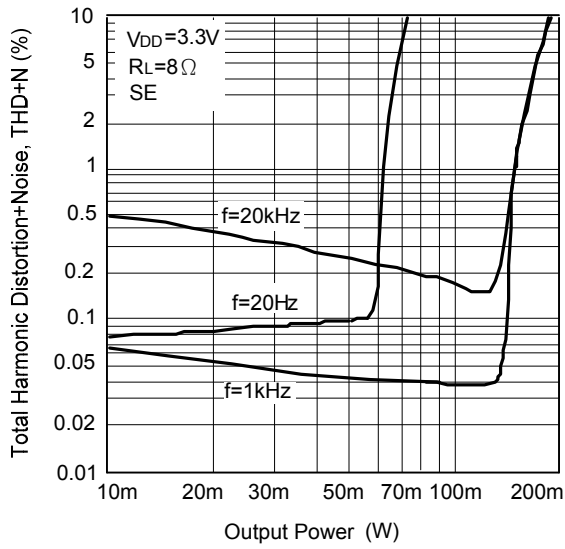

■ TYPICAL CHARACTERISTICS(cont.)

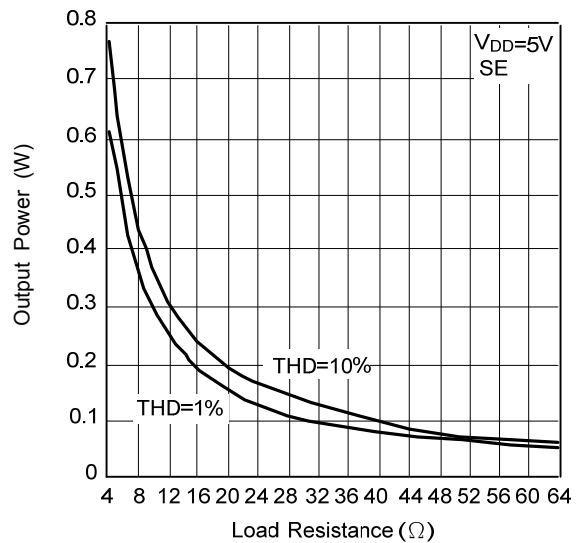
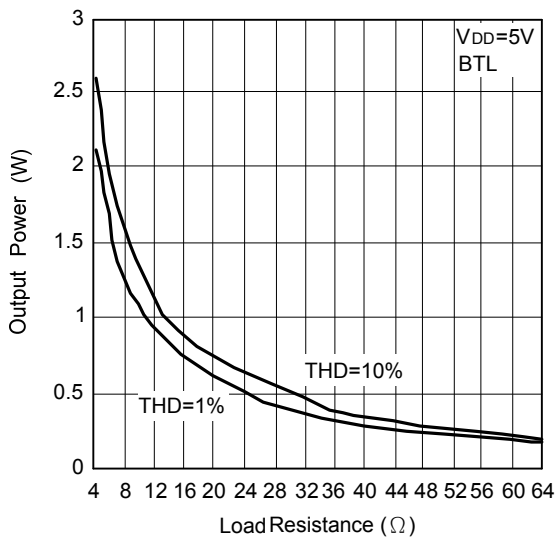
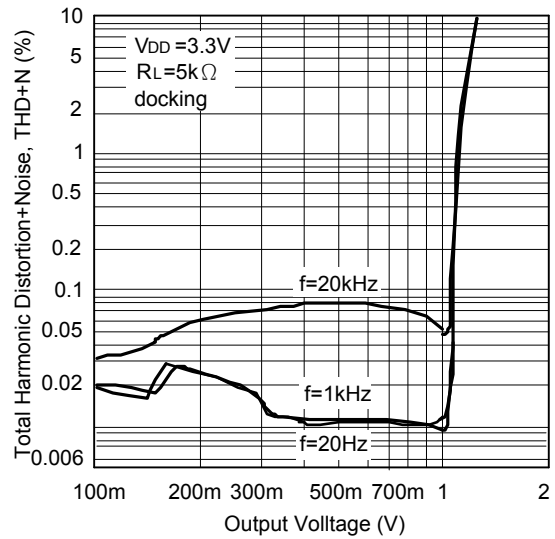
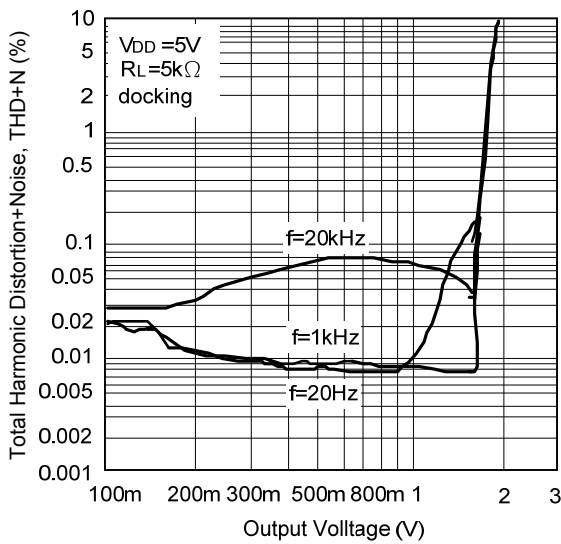
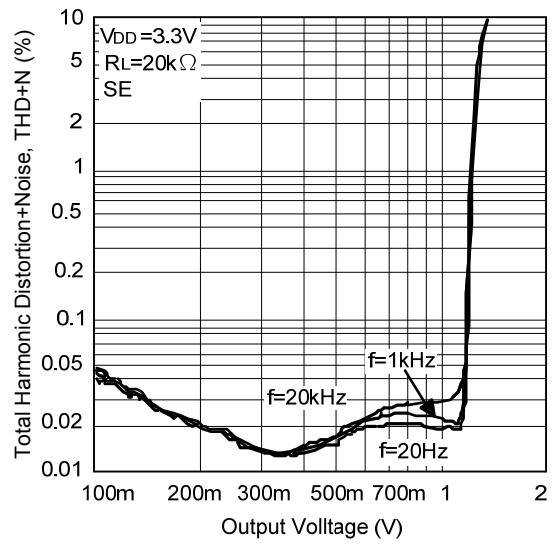
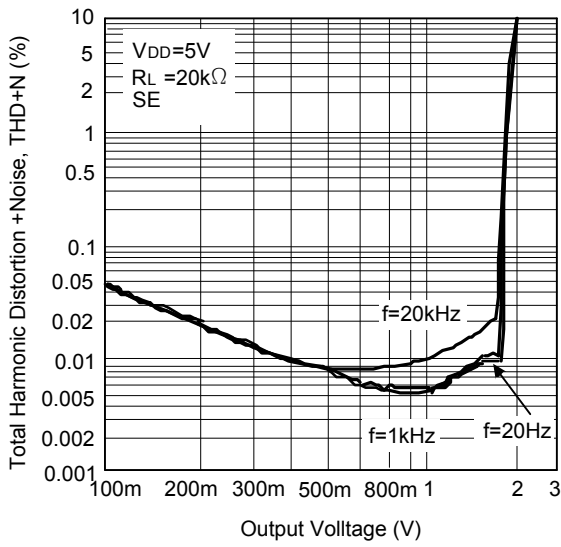

■ TYPICAL CHARACTERISTICS(cont.)

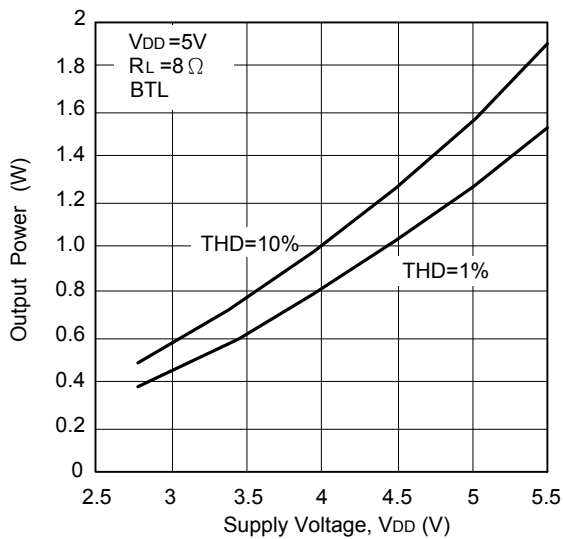
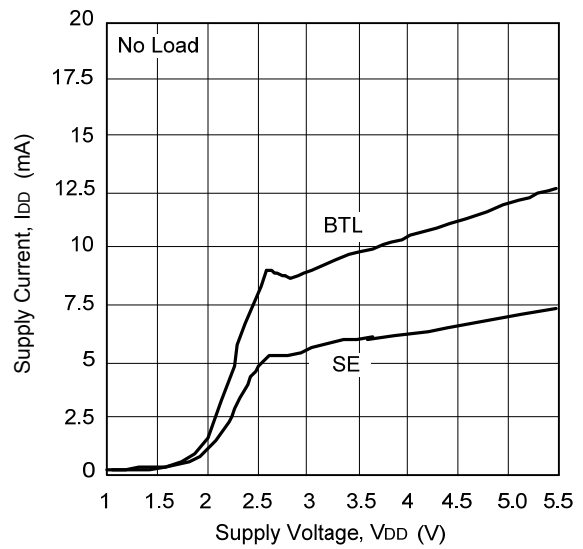
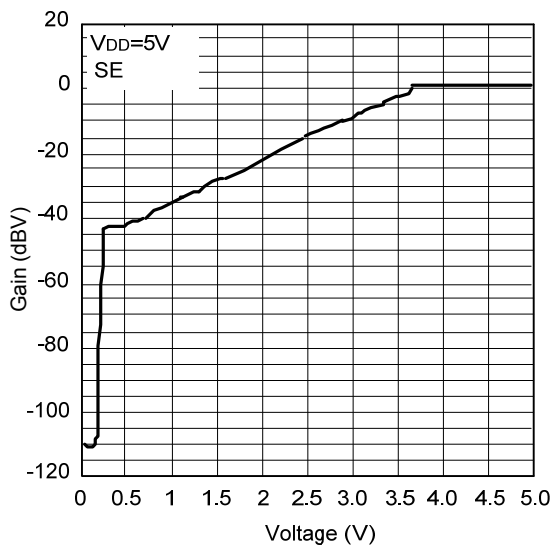
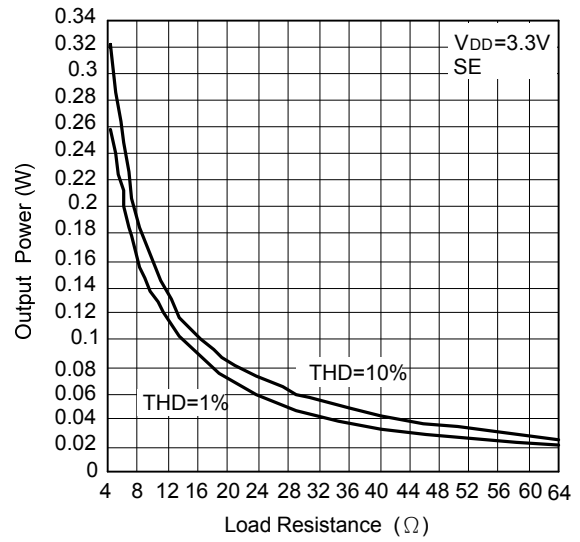
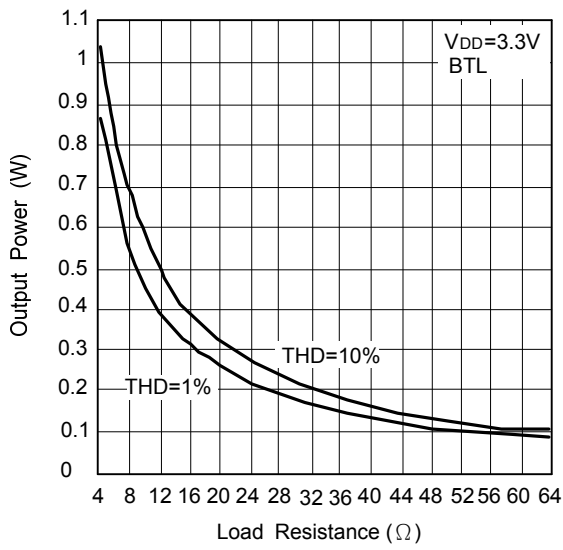

UTC assumes no responsibility for equipment failures that result from using products at values that exceed, even momentarily, rated values (such as maximum ratings, operating condition ranges, or other parameters) listed in products specifications of any and all UTC products described or contained herein. UTC products are not designed for use in life support appliances, devices or systems where malfunction of these products can be reasonably expected to result in personal injury. Reproduction in whole or in part is prohibited without the prior written consent of the copyright owner. The information presented in this document does not form part of any quotation or contract, is believed to be accurate and reliable and may be changed without notice.