

IEC Appliance Connector C14 with CBE 1- or 2-pole

new



C14



70° C



Description

- Panel Mount:
Screw-on version from front or rear side, snap-in version from front side
- 2 Functions:
Inlet Protection class I, Fuseholder circuit breaker type TA45 2-pole
- Quick connect terminals 6.3 x 0.8 mm
- Alternative: version with line filter [DF12](#)
- Substitute for type [6145](#)

Characteristics

- All single elements are already wired
- Line switch non-illuminated or illuminated
Thermal overload protection
Optional with undervoltage release or remote trip release
- Qualified for use in equipment according IEC/EN 60950

Other versions on request

- Unwired versions
- Line switch 1-pole
- Other rocker marking

Weblinks

Approvals: www.schurter.com/approvals
 RoHS: <http://www.schurter.com/rohs>
 CHINA-RoHS: www.schurter.com/china-rohs
 Webstore: www.schurterinc.com/estore/search.ihtml

Technical Data

Ratings IEC	10A / 250VAC; Hz 50
Ratings UL/CSA	1 - 15A / 250VAC; 60Hz
Dielectric Strength	> 2.5kVAC between L-N > 3kVAC between L/N-PE (1 min/50Hz)
Allowable Operation Temp.	-10°C to 55°C
Degree of Protection	from front side IP 40 acc. to IEC 60529
Protection Class	Suitable for appliances with protection class I acc. to IEC 61140
Terminal	Quick connect terminals 6.3 x 0.8 mm
Panel Thickness s	Screw-on: max 8mm Mounting screw torque max 0.5Nm Snap-in: 1/1.5/2/2.5/3 mm
Material: Housing	Thermoplastic, black, UL 94V-0

Appliance-Inlet /-Outlet	C14 acc. to IEC/EN 60320-1, UL 498, CSA C22.2 no. 42 (for cold condition) pin-temperature 70 °C, 10A, Protection class I
Circuit breaker	Acc. IEC/EN 60934, UL 1077, CSA 22.2 no. 235 2-pole rocker switch, illuminated or non-illuminated. Optional with undervoltage- or remote trip release Short circuit capacity I _{cn} : at I _n < 3A/240VAC : 10 x I _n at I _n ≥ 3A/240VAC : 300A
Line Switch	Rocker switch 2-pole, non-illuminated or illuminated, acc. to IEC 61058-1 Technical details

Dimensions

Length |-----| 91.5 mm

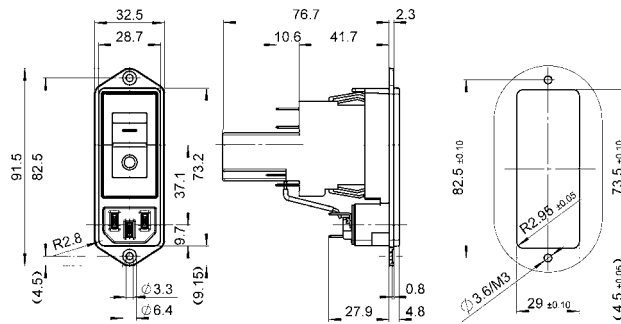

* Version TA45 with undervoltage release

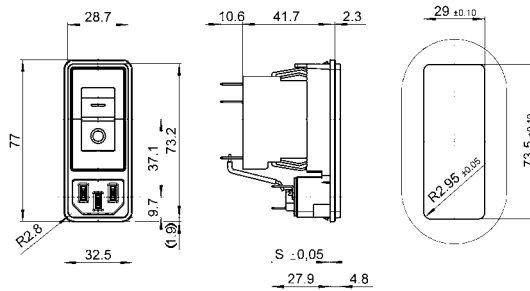

Diagrams

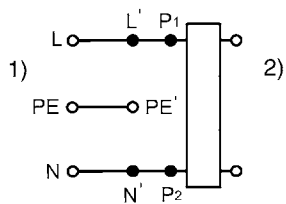

1) Line
2) Load

Packaging unit

20 Pcs

Accessory

Description

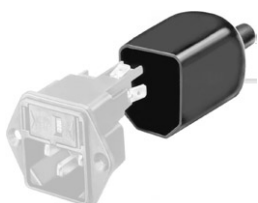

Assorted Covers
Rear Cover

0098.0078 Rear Cover
0859.0047 Rear Cover
0859.0048 Rear Cover
0859.0072 Rear Cover
...

Table 1 Selection for type TA45

Order example



- Line switch
 - 2-pole, rocker actuated
 - Quick connect terminal
- Other types on request

ABT W F 150 C0

Diagram

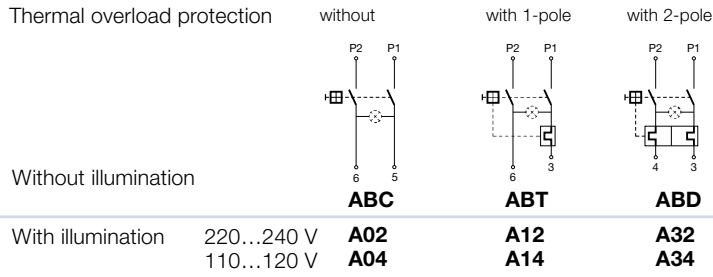

Colours

Switch front	Rocker	
W black	white	—
B black	black	—
6 black	—	orange transp.

Rocker legend

Surface	Illustration	Colour of print	Surface	Illustration	Colour of print
F embossed / Relief	— ○		M printed	— ○	black
H printed / bedruckt	ON OFF	white / weiss	P printed	I ○	white
K printed / bedruckt	ON OFF	black / schwarz	R printed	I ○	black
L printed / bedruckt	— ○	white / weiss			

Position of the rocker legend
e.g F

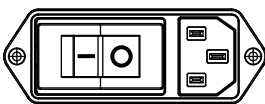

Rated current:

- Without thermal overload protection: code C00 } $I_n = 20\text{ A}$
- With thermal overload protection: rated current I_n (A)

I_n	Code	I_n	Code	I_n	Code	I_n	Code
0,1	J01	1,3	J13	2,8	J28	10,0	100
0,2	J02	1,4	J14	3,0	J30	11,0	110
0,3	J03	1,5	J15	3,5	J35	12,0	120
0,4	J04	1,6	J16	4,0	J40	13,0	130
0,5	J05	1,7	J17	4,5	J45	14,0	140
0,6	J06	1,8	J18	5,0	J50	15,0	150
0,7	J07	1,9	J19	6,0	J60		
0,8	J08	2,0	J20	6,5	J65		
0,9	J09	2,1	J21	7,0	J70		
1,0	J10	2,2	J22	7,5	J75		
1,1	J11	2,3	J23	8,0	J80		
1,2	J12	2,5	J25	9,0	J90		

Without release: code C0

Undervoltage release

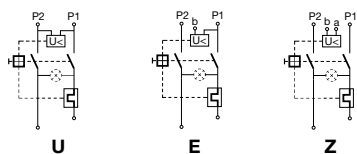

•	•	•
•	•	•
•	•	•

Remote trip release

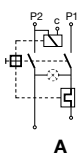

Code	Rated voltage U_n
2	240 V AC
3	230 V AC
4	120 V AC

Technical data (continued)
Circuit breaker

Tripping characteristics
 $I_n < 3 A$

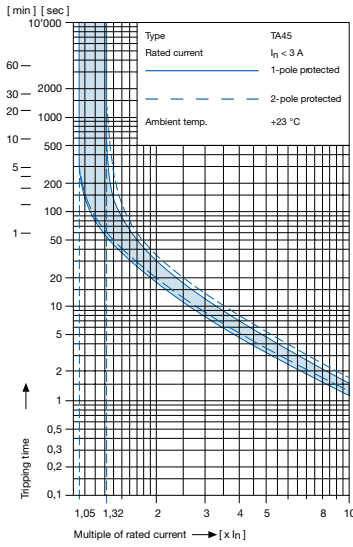

Tripping characteristics
 $I_n \geq 3 \dots \leq 15 A$

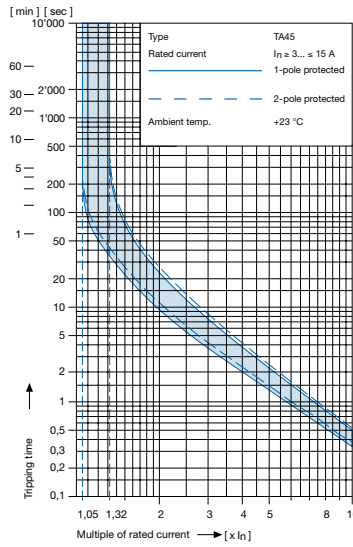

Effect of ambient temperature ¹⁾

The unit is calibrated for an ambient temperature of +23 °C. To determine the rated current for a lower or higher ambient temperature, use a correction factor from the table below.

*** Ambient temperature [°C] Correction factor**

-10	0,89
- 5	0,91
0	0,92
+23	1,00
+30	1,03
+40	1,08
+55	1,16

* Temperature must be measured at the rear of the breaker next to the terminals after equipment operating temperature has been reached.

¹⁾ Example

Rated current at +23 °C	6,0 A
Ambient temperature	+40 °C
Correction factor	1,08
Chosen rated current at +40 °C ambient temperature	6 A x 1,08 = 6,5 A

Order code (Order example)

Type	Order code TA 45 (2-pole rocker-switch without accessories)
DF11.	A B T W F 1 5 0 C 0 see table 1
	. 0 0 1 0 . 0 1

Wiring
1 wired
2 unwired

Protection class
0 Protection class I

Mounting
0 Screw
1 Snap-in s = 1.0 mm
2 Snap-in s = 1.5 mm
3 Snap-in s = 2.0 mm
4 Snap-in s = 2.5 mm
5 Snap-in s = 3.0 mm

Terminals
1 Quick connect 6.3 x 0.8
0 Without line filter
0 Without line filter

Please note that Schurter will establish an internal part number for logistical use in addition to the order code. The format of this internal part number is, for example DF12.xxxxxxx