

Inlet filter, front side mounting, circuit breaker TA45 2-pole

Standard- or Medical-Filter



Screw-On Version



Description

- Panel Mount:
Screw-on from front side
- 3 Functions:
Appliance Inlet Protection class I, circuit breaker type TA45 2-pole, Line filter in standard and medical version
- Quick connect terminals 6.3 x 0.8 mm
- Alternative: version without line filter [6145](#)
- We recommend for new applications the new type [DF12](#)

Approvals

- VDE License Number: 117118
- UL License Number: E72928

Characteristics

- All single elements are already wired
Unwired versions available on request
- Line switch non-illuminated or illuminated
Thermal overload protection
- Optional with undervoltage release or remote trip release
- Qualified for use in equipment according IEC/EN 60950

Weblinks

[Approvals](#), [RoHS](#), [CHINA-RoHS](#), [e-Store](#), [SCHURTER-Stock-Check](#), [Distributor-Stock-Check](#)

Technical Data

Ratings IEC	1 - 10A @ Ta 40 °C / 250VAC; 50Hz
Ratings UL/CSA	1 - 15A @ Ta 40 °C / 125VAC; 60Hz
Leakage Current	standard < 0.5 mA (250 V / 60Hz) medical < 5 µA (250 V / 60 Hz)
Dielectric Strength	> 1.7 kVDC between L-N > 2.7 kVDC between L/N-PE Test voltage (2 sec)
Allowable Operation Temp.	-10°C to 55°C
Climatic Category	10/055/21 acc. to, IEC 60068-1
Degree of Protection	from front side IP 40 acc. to IEC 60529
Protection Class	Suitable for appliances with protection class I acc. to IEC 61140
Terminal	Quick connect terminals 6.3 x 0.8 mm
Panel Thickness s	Screw-on: max 8 mm Mounting screw torque max 0.5 Nm
Material: Housing	Thermoplastic, black, UL 94V-0

Appliance-Inlet/-Outlet	C14 acc. to IEC/EN 60320-1, UL 498, CSA C22.2 no. 42 (for cold conditions) pin-temperature 70 °C, 10A, Protection class I
Circuit breaker	Acc. IEC/EN 60934, UL 1077, CSA 22.2 no. 235 2-pole rocker switch, illuminated or non-illuminated. Optional with undervoltage- or remote trip release Short circuit capacity Icn: at In < 3A/240VAC : 10 x In at In ≥ 3A/240VAC : 300A
Line Switch	Rocker switch 2-pole non-illuminated or illuminated acc. to IEC 61058-1 Technical details
Line Filter	Standard and Medical Version, IEC 60939, IEC 60601-1, UL 1283, UL 544, EN 133 200, CSA C22.2 no. 8 Technical details
MTBF	> 100'000h acc. to MIL-HB-217 F

Dimensions

Length |-----| 67.5 mm

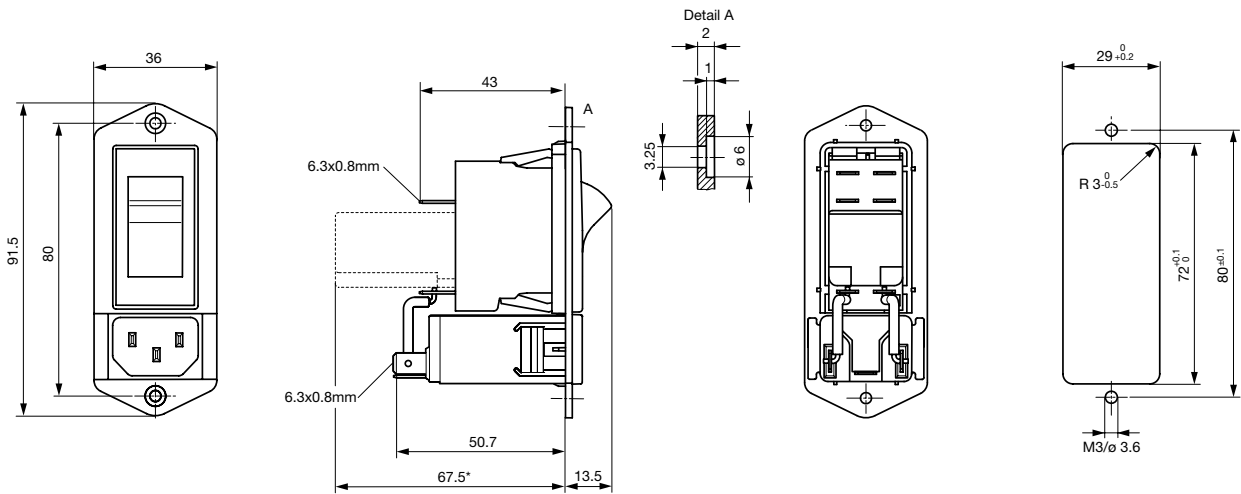

* --- Version TA45 with undervoltage release

Technical Data of Filter-Components

Rated Current [A]	Filter-Type	Inductances L [mH]	Capacitance CX [nF]	Capacitance CY [nF]	R [MΩ]
1	Standard Version	2 x 11	47	2.2	-
2	Standard Version	2 x 4	47	2.2	-
3	Standard Version	2 x 2.5	47	2.2	-
4	Standard Version	2 x 1.6	47	2.2	-
6	Standard Version	2 x 0.7	47	2.2	-
8	Standard Version	2 x 0.6	47	2.2	-
10	Standard Version	2 x 0.4	47	2.2	-
15	Standard Version	2 x 0.1	47	2.2	-
1	Medical Version (M5)	2 x 11	47	-	1
2	Medical Version (M5)	2 x 4	47	-	1
6	Medical Version (M5)	2 x 0.7	47	-	1
8	Medical Version (M5)	2 x 0.6	47	-	1
10	Medical Version (M5)	2 x 0.4	47	-	1
15	Medical Version (M5)	2 x 0.1	47	-	1

Diagrams

Standard version

Medical version

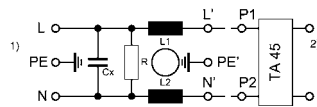
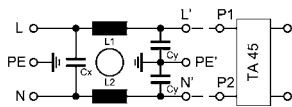

1) Line
2) Load

1) Line
2) Load

Table 1 Selection for type TA45

Order example



- Line switch
 - 2-pole, rocker actuated
 - Quick connect terminal
- Other types on request

ABT **W** **F** **150** **C0**

Diagram

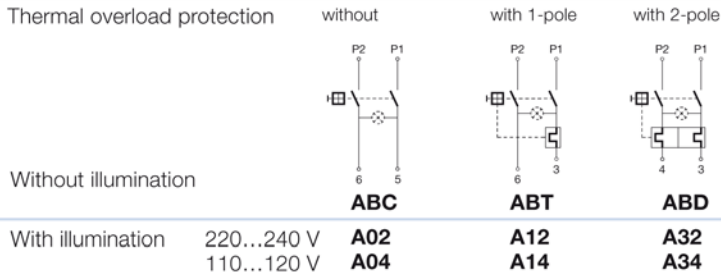

Colours

Switch front	Rocker	
W black	white	—
B black	black	—
6 black	—	orange transp.

Rocker legend

Surface	Illustration	Colour of print	Surface	Illustration	Colour of print
F embossed / Relief		—	M printed		black
H printed / bedruckt		white / weiss	P printed		white
K printed / bedruckt		black / schwarz	R printed		black
L printed / bedruckt		white / weiss			

Position of the rocker legend e.g F

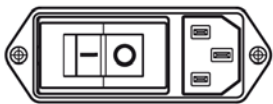

Rated current:

- Without thermal overload protection: code C00 } $I_n = 20\text{ A}$
- With thermal overload protection: rated current I_n (A)

I_n	Code	I_n	Code	I_n	Code	I_n	Code
0,1	J01	1,3	J13	2,8	J28	10,0	100
0,2	J02	1,4	J14	3,0	030	11,0	110
0,3	J03	1,5	J15	3,5	035	12,0	120
0,4	J04	1,6	J16	4,0	040	13,0	130
0,5	J05	1,7	J17	4,5	045	14,0	140
0,6	J06	1,8	J18	5,0	050	15,0	150
0,7	J07	1,9	J19	6,0	060		
0,8	J08	2,0	J20	6,5	065		
0,9	J09	2,1	J21	7,0	070		
1,0	J10	2,2	J22	7,5	075		
1,1	J11	2,3	J23	8,0	080		
1,2	J12	2,5	J25	9,0	090		

Without release: code C0

Undervoltage release

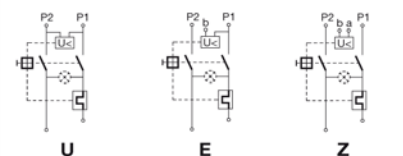

•	•	•
•	•	•
•	•	•

Remote trip release



Code	Rated voltage U_n
•	2 240 V AC
•	3 230 V AC
•	4 120 V AC

Packaging unit 20 Pcs

Accessory

Description



Assorted Covers
Rear Cover

0859.0074

Passende Dose

Category / Description



Appliance Outlet

IEC appliance outlet F, screw-on mounting, front side, solder /quick connect terminal	4787
IEC appliance outlet F, screw-on mounting, front side, solder /quick connect terminal	4788
IEC appliance outlet F oder H, screw-on mounting, front side, solder/PCB/quick connect terminal	5091
IEC appliance outlet F oder H, screw-on mounting, front side, solder/quick connect terminal	5092

Connector



IEC cord connector C15, rewirable, straight	0101
IEC cord connector C15A, rewirable, straight	0102
IEC cord connector C15A, rewirable, straight	0102-G
IEC cord connector C15A, rewirable, angled	0112
IEC cord connector C13, rewirable, angled	4012
IEC cord connector C13, rewirable, angled	4013
IEC cord connector C13, rewirable, straight	4020
IEC cord connector C13, rewirable, straight	4021
IEC cord connector C13, rewirable, straight	4022
IEC cord connector C13, rewirable, angled	4300-06

...

Power Supply or Interconnection Cord



Power Cord with IEC Appliance Connector C13, angled, 70°C	0311
Power Cord with IEC Appliance Connector C13, angled, 70°C	3011
Power Cord with IEC Appliance Connector C13, angled, 70°C	3012
Power Cord with IEC Appliance Connector C13, angled, 70°C	3013
Power Cord with IEC Appliance Connector C13, 70°C	3020
Power Cord with IEC Appliance Connector C13, straight, 70°C	3027
Power Cord with IEC Appliance Connector C13, straight, 70°C	302U
Power Cord with IEC Appliance Connector C13, straight, 70°C	3030
Power Cord with IEC Appliance Connector C13, angled, 70°C	311L
Power Cord with IEC Appliance Connector C13, angled, 70°C	312L

...

Technical data (continued)
Circuit breaker

Tripping characteristics
 $I_n < 3 A$

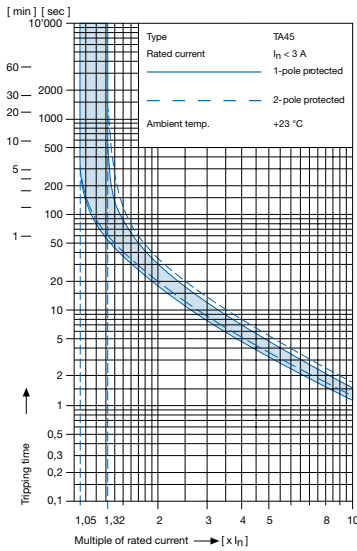

Tripping characteristics
 $I_n \geq 3... \leq 15 A$

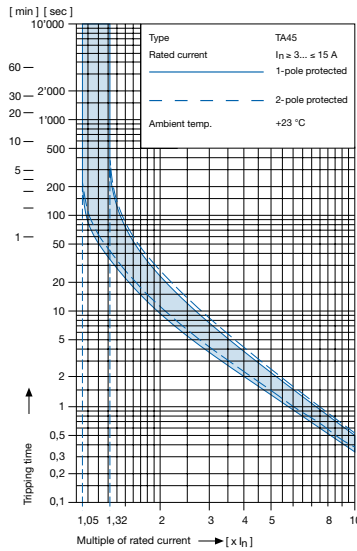

Effect of ambient temperature ¹⁾

The unit is calibrated for an ambient temperature of +23 °C. To determine the rated current for a lower or higher ambient temperature, use a correction factor from the table below.

*** Ambient temperature [°C] Correction factor**

-10	0,89
- 5	0,91
0	0,92
+23	1,00
+30	1,03
+40	1,08
+55	1,16

* Temperature must be measured at the rear of the breaker next to the terminals after equipment operating temperature has been reached.

¹⁾ Example

Rated current at +23 °C	6,0 A
Ambient temperature	+40 °C
Correction factor	1,08
Chosen rated current at + 40 °C ambient temperature	6 A x 1,08 = 6,5 A

Order code (Order example)

Type	Order code TA45 (2-pole rocker-switch without accessories)	Wiring 0 Without 1 With
5145.	A B T W F 1 5 0 C 0 see table 1	Type of line filter 1 Standard 3 Medical
	. 0 0 1	Rated current of line filter 1 1 (A) 5 6 (A) 2 2 (A) 6 8 (A) 3 3 (A) 7 10 (A) 4 4 (A) 8 15 (A)

Please note that Schurter will establish an internal part number for logistical use in addition to the order code. The format of this internal part number is, for example 5145.0031.001