

FEATURES

- 15 dB Gain
- Very Low Distortion
- Excellent Input/Output Match
- Low DC Power Consumption
- Good RF Stability with High VSWR Load Conditions
- RoHS-compliant Surface Mount Package Compatible with Automatic Assembly
- Repeatability of Monolithic Fabrication
- Meets Cenelec Standard
- 1 GHz Specified Performance

APPLICATIONS

- CATV Distribution Amplifier
- High Linearity CATV Amplifier



PRODUCT DESCRIPTION

The ACA1206 is a surface mount monolithic GaAs RF Linear Amplifier that has been developed to replace, in new designs, the standard CATV Hybrid amplifiers currently in use. The MMIC consist of two parallel amplifiers, each with 15 dB gain. The

amplifier is optimized for exceptionally low distortion and noise figure while providing flat gain and excellent input and output return loss for applications up to 1 GHz. The device requires single +12 V supply, and is offered in a RoHS-compliant package.

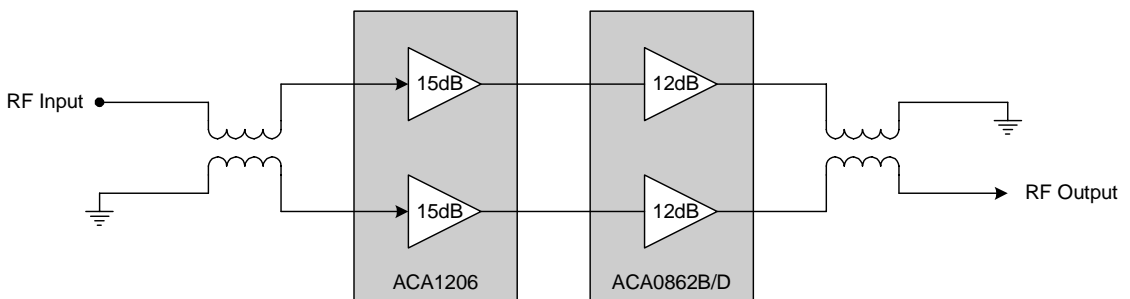

Figure 1: Hybrid Application Diagram

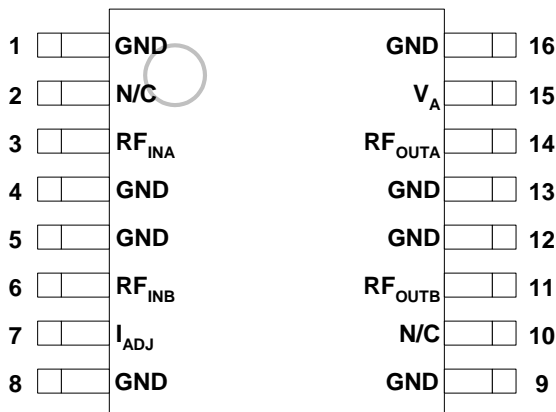

Figure 2: Pin Out

Table 1: Pin Description

PIN	NAME	DESCRIPTION	PIN	NAME	DESCRIPTION
1	GND	Ground	9	GND	Ground
2	N/C	No Connection	10	N/C	No Connection
3	RF _{INA}	Input to Amplifier A	11	RF _{OUTB}	Output from Amplifier B
4	GND	Ground	12	GND	Ground
5	GND	Ground	13	GND	Ground
6	RF _{INB}	Input to Amplifier B	14	RF _{OUTA}	Output from Amplifier A
7	I _{ADJ}	Current Adjust	15	V _A	Supply for Amplifier A
8	GND	Ground	16	GND	Ground

ELECTRICAL CHARACTERISTICS

Table 2: Absolute Minimum and Maximum Ratings

PARAMETER	MIN	MAX	UNIT
Amplifier Supplies (pins 10, 11, 14, 15)	0	+15	VDC
RF Input Power (pins 3, 6)	-	+70	dBmV
Storage Temperature	-65	+150	°C
Soldering Temperature	-	+260	°C
Soldering Time	-	5.0	sec

Stresses in excess of the absolute ratings may cause permanent damage. Functional operation is not implied under these conditions. Exposure to absolute ratings for extended periods of time may adversely affect reliability.

Notes:

1. Pins 3 and 6 should be AC-coupled. No external DC bias should be applied.

Table 3: Operating Ranges

PARAMETER	MIN	TYP	MAX	UNIT
RF Frequency	40	-	1000	MHz
Supply: V_{DD} (pins 10, 11, 14, 15)	-	+12	-	VDC
Operating Temperature	-40	-	+110	°C

The device may be operated safely over these conditions; however, parametric performance is guaranteed only over the conditions defined in the electrical specifications.

Table 4: Electrical Specifications
(T_A = +25°C, V_{DD} = +12 VDC)

PARAMETER	MIN	TYP	MAX	UNIT	COMMENTS
Gain at 1 GHz ⁽¹⁾	13.7	14.2	14.7	dB	
Gain Flatness	-	0.1 ± 0.1	-	dB	45 to 100 MHz
	-	± 0.3	-		100 to 800 MHz
	-	0.1 ± 0.1	-		800 to 1002 MHz
Noise Figure at 1 GHz ⁽¹⁾	-	3.0	3.5	dB	
CTB 195 mA ^{(1), (3), (4)}	-	-72	-69	dBc	77 Channels
	-	-75	-		110 Channels
	-	-	-		128 Channels
CTB 325 mA ^{(1), (2), (5)}	-	-75	-72	dBc	77 Channels
	-	-74	-		110 Channels
	-	-	-		128 Channels
CSO 195 mA ^{(1), (3), (4)}	-	-75	-68	dBc	77 Channels
	-	-77	-		110 Channels
	-	-	-		128 Channels
CSO 325 mA ^{(1), (2), (5)}	-	-75	-64	dBc	77 Channels
	-	-72	-		110 Channels
	-	-	-		128 Channels
XMOD 195 mA ^{(1), (3), (4)}	-	-64	-61	dBc	77 Channels
	-	-68	-		110 Channels
	-	-	-		128 Channels
XMOD 325 mA ^{(1), (2), (5)}	-	-69	-67	dBc	77 Channels
	-	-70	-		110 Channels
	-	-	-		128 Channels
Supply Current (I _{DD})	185 300	195 325	205 350	mA	R1 = 5.2 kΩ R1 = 2 kΩ
Cable Equivalent Slope ⁽¹⁾	-	TBD	-	dB	
Return Loss ⁽¹⁾	18	22	-	dB	
Thermal Resistance	-	-	6.0	°C/W	

Notes:

(1) Measured with a balun on the input and output of the device. See Figure 3 for test setup.

(2) 15.6 dB tilt, 49 dBmV output (per channel) at 1002 MHz plus QAM set 6 dBmV down from carrier.

(3) 3 dB tilt, 37 dBmV output (per channel) at 1002 MHz plus QAM set 6 dBmV down from carrier.

(4) Tested with R1 = 5.2 kΩ

(5) Tested with R1 = 2 kΩ

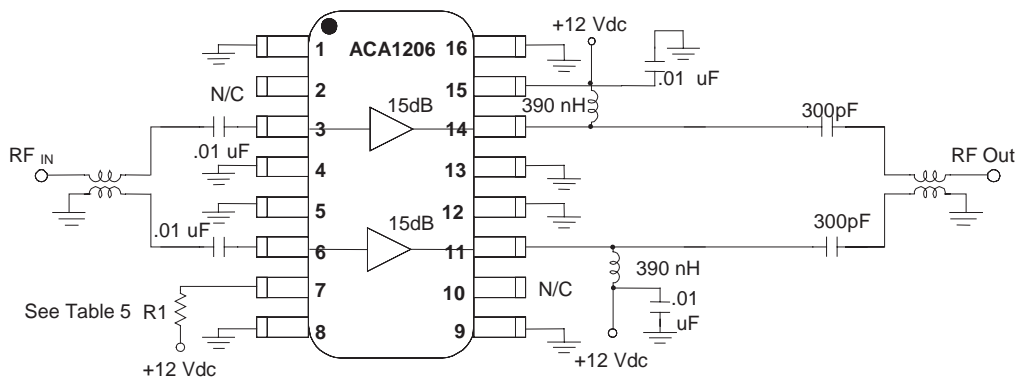

Note: Apply voltage to both +12Vdc lines simultaneously

Figure 3: Test Circuit

Table 5

NOMINAL CURRENT	R1
195 mA	5.2 kΩ
325 mA	2 kΩ

PERFORMANCE DATA

Figure 4: Gain vs. Frequency
($V_{DD} = +12\text{ V}$, $I_{DD} = 195\text{ mA}$)

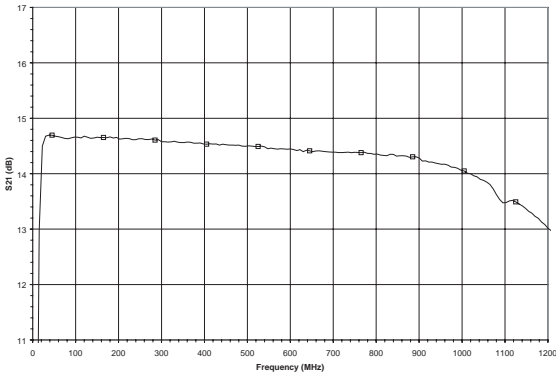

Figure 5: Reverse Isolation vs. Frequency
($V_{DD} = +12\text{ V}$, $I_{DD} = 195\text{ mA}$)

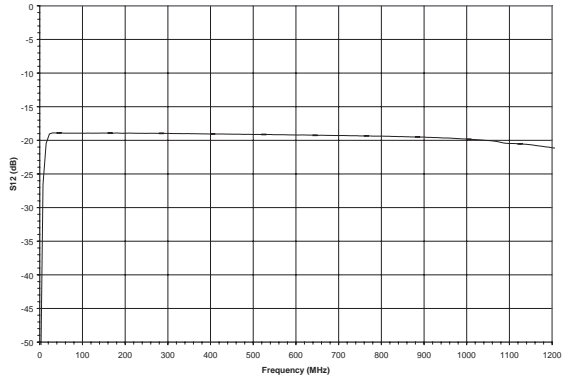

Figure 6: Input Return Loss vs. Frequency
($V_{DD} = +12\text{ V}$, $I_{DD} = 195\text{ mA}$)

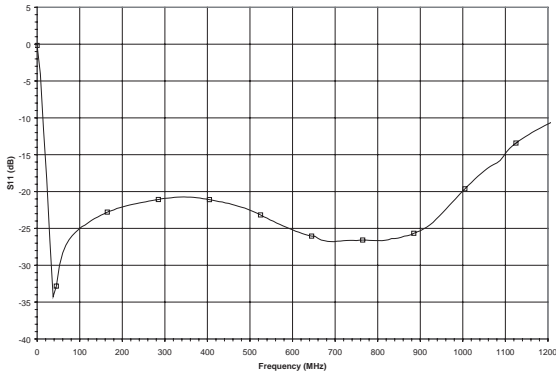

Figure 7: Output Return Loss vs. Frequency
($V_{DD} = +12\text{ V}$, $I_{DD} = 195\text{ mA}$)

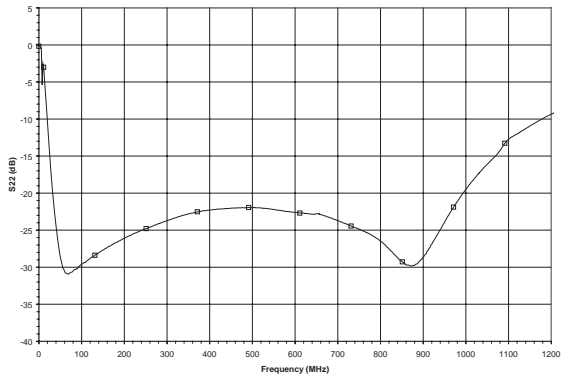

Figure 8: Noise Figure vs. Frequency
($V_{DD} = +12\text{ V}$, $I_{DD} = 195\text{ mA}$)

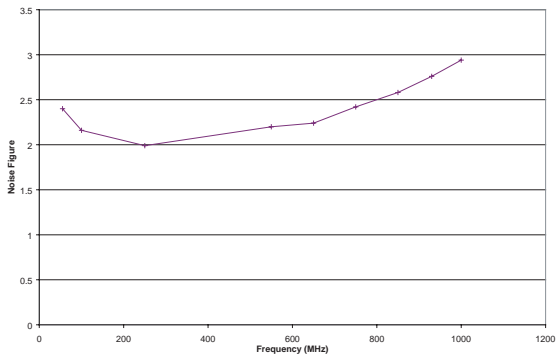

Figure 9: CTB vs. Frequency
 ($V_{DD} = +12\text{ V}$, $I_{DD} = 195\text{ mA}$, 79 Analog Channels, 3 dB Tilt, +37 dBmV output power at 1 GHz)

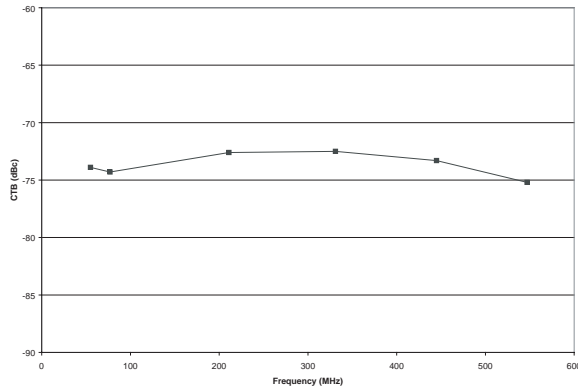

Figure 10: CSO vs. Frequency
 ($V_{DD} = +12\text{ V}$, $I_{DD} = 195\text{ mA}$, 79 Analog Channels, 3 dB Tilt, +37 dBmV output power at 1 GHz)

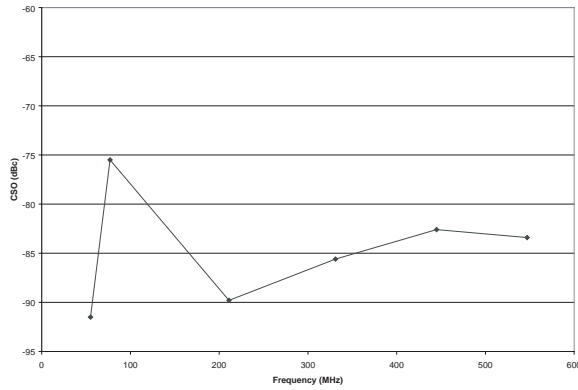

Figure 11: XMOD vs. Frequency
 ($V_{DD} = +12\text{ V}$, $I_{DD} = 195\text{ mA}$, 79 Analog Channels, 3 dB Tilt, +37 dBmV output power at 1 GHz)

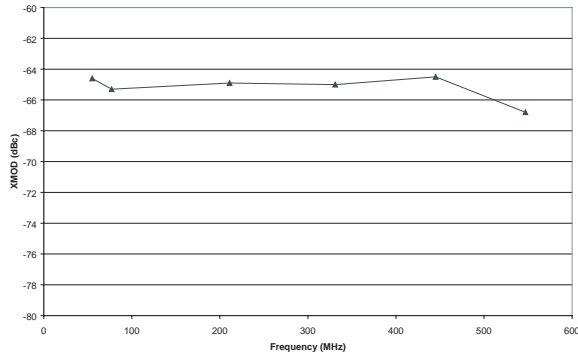

Figure 12: CTB vs. Frequency
($V_{DD} = +12\text{ V}$, $I_{DD} = 195\text{ mA}$, 112 Analog Channels, 3 dB Tilt, +37 dBmV output power at 1 GHz)

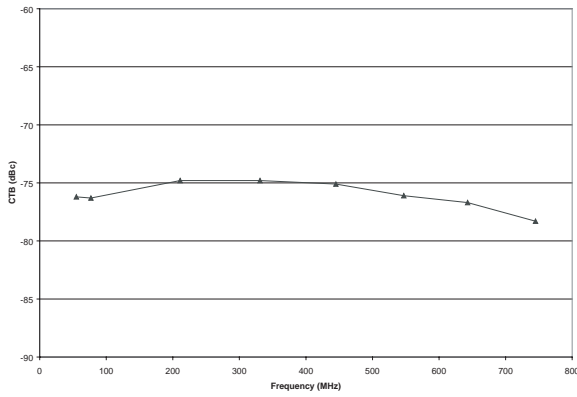

Figure 13: CSO vs. Frequency
($V_{DD} = +12\text{ V}$, $I_{DD} = 195\text{ mA}$, 112 Analog Channels, 3 dB Tilt, +37 dBmV output power at 1 GHz)

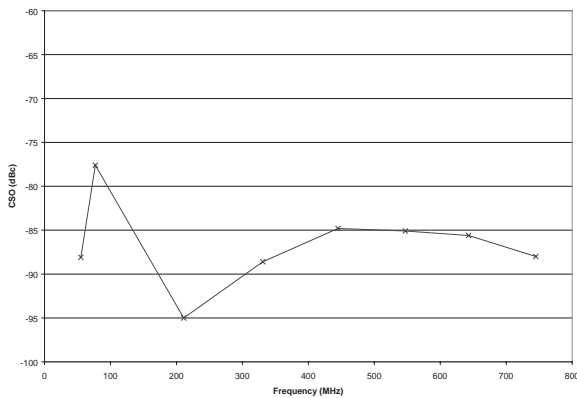

Figure 14: XMOD vs. Frequency
($V_{DD} = +12\text{ V}$, $I_{DD} = 195\text{ mA}$, 112 Analog Channels, 3 dB Tilt, +37 dBmV output power at 1 GHz)

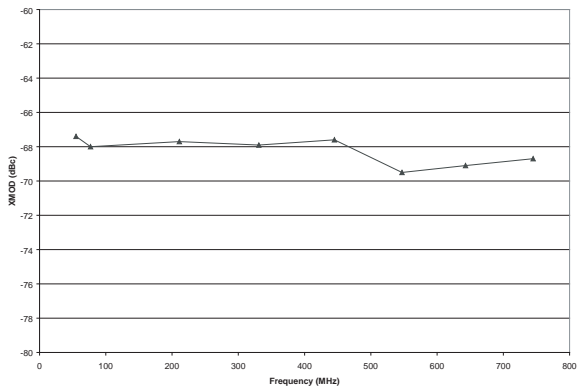

Figure 15: Gain vs. Frequency
($V_{DD} = +12\text{ V}$, $I_{DD} = 325\text{ mA}$)

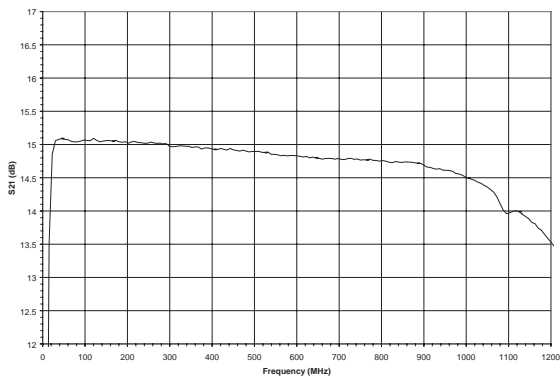

Figure 16: Reverse Isolation vs. Frequency
($V_{DD} = +12\text{ V}$, $I_{DD} = 325\text{ mA}$)

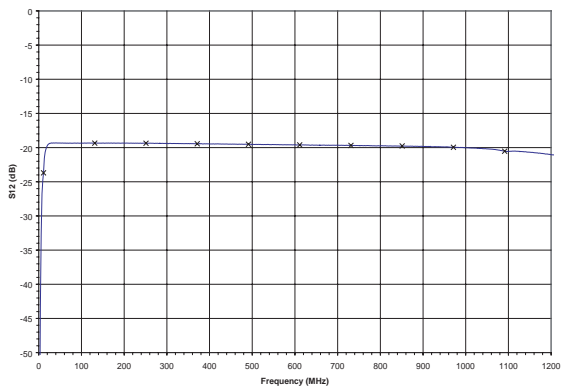

Figure 17: Input Return Loss vs. Frequency
($V_{DD} = +12\text{ V}$, $I_{DD} = 325\text{ mA}$)

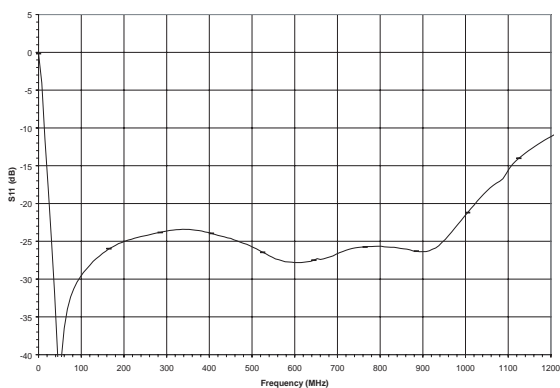

Figure 18: Output Return Loss vs. Frequency
($V_{DD} = +12\text{ V}$, $I_{DD} = 325\text{ mA}$)

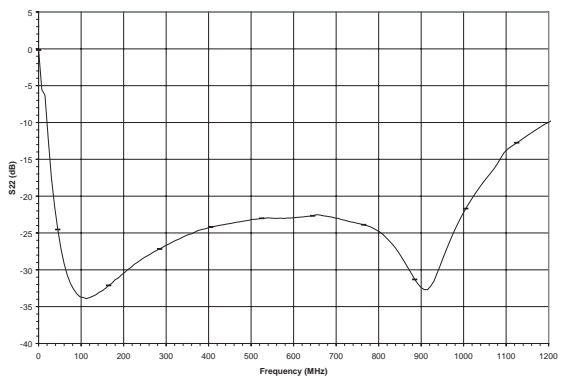

Figure 19: Noise Figure vs. Frequency
($V_{DD} = +12\text{ V}$, $I_{DD} = 325\text{ mA}$)

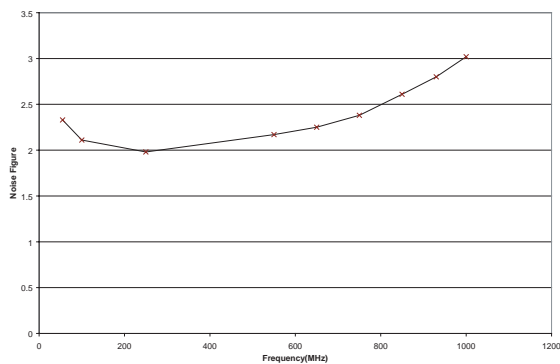

Figure 20: CTB vs. Frequency
 ($V_{DD} = +12\text{ V}$, $I_{DD} = 325\text{ mA}$, 79 Analog Channels, 15.6 dB Tilt, +49 dBmV output power at 1 GHz)

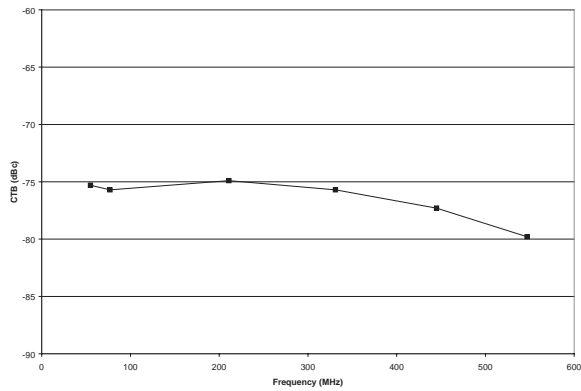

Figure 21: CSO vs. Frequency
 ($V_{DD} = +12\text{ V}$, $I_{DD} = 325\text{ mA}$, 79 Analog Channels, 15.6 dB Tilt, +49 dBmV output power at 1 GHz)

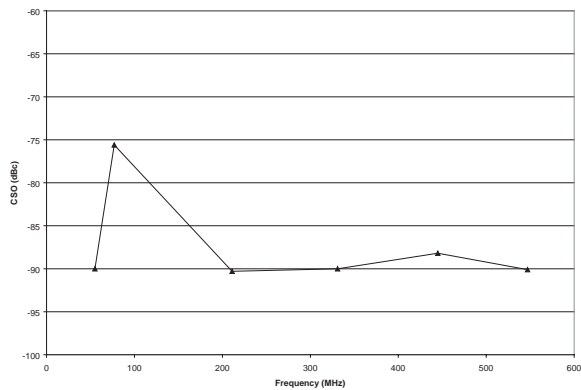

Figure 22: XMOD vs. Frequency
 ($V_{DD} = +12\text{ V}$, $I_{DD} = 325\text{ mA}$, 79 Analog Channels, 15.6 dB Tilt, +49 dBmV output power at 1 GHz)

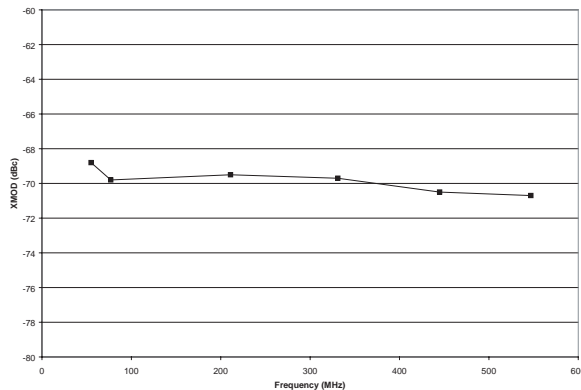

Figure 23: CTB vs. Frequency

($V_{DD} = +12\text{ V}$, $I_{DD} = 325\text{ mA}$, 112 Analog Channels, 15.6 dB Tilt, +49 dBmV output power at 1 GHz)

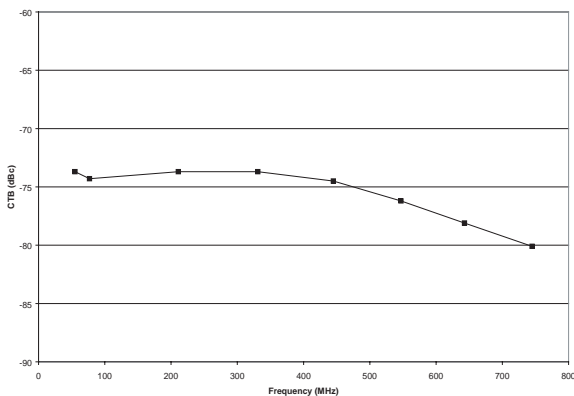

Figure 24: CSO vs. Frequency

($V_{DD} = +12\text{ V}$, $I_{DD} = 325\text{ mA}$, 112 Analog Channels, 15.6 dB Tilt, +49 dBmV output power at 1 GHz)

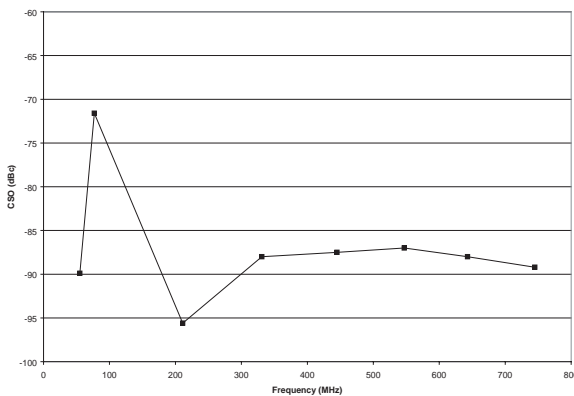
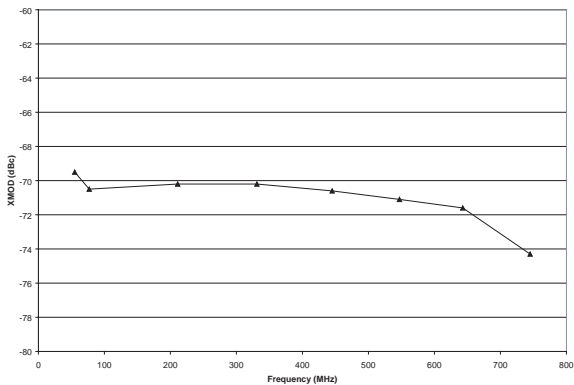

Figure 25: XMOD vs. Frequency

($V_{DD} = +12\text{ V}$, $I_{DD} = 325\text{ mA}$, 112 Analog Channels, 15.6 dB Tilt, +49 dBmV output power at 1 GHz)



APPLICATION INFORMATION

The ACA1206 is designed as an input stage. This part can be used alone for low gain, low output level applications or can be cascaded with one of the ACA0862 output stages for higher gain and output

signal drive level. The ACA1206 is a low power dissipation part designed as a driver for the ACA0862B output stage.

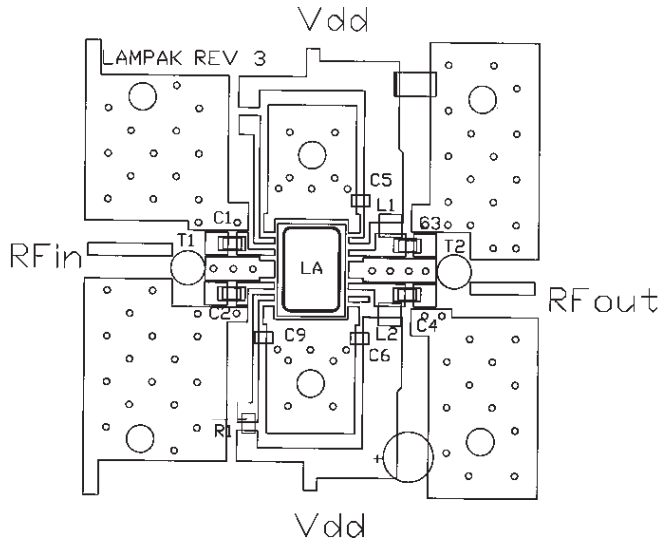

Figure 26: Evaluation Board Layout

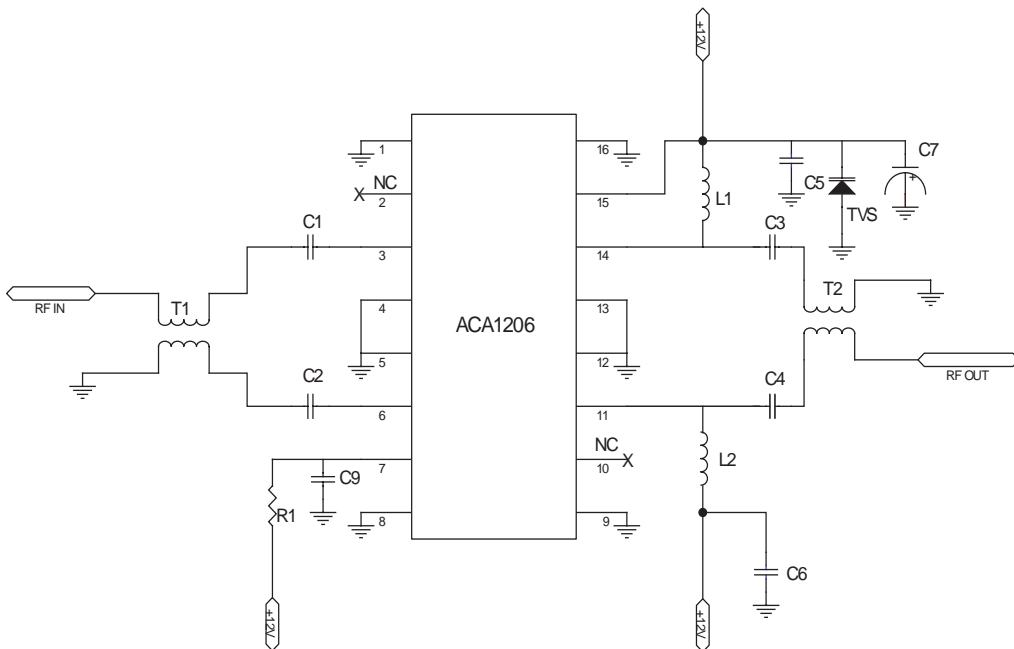

Figure 27: Evaluation Board Schematic

Table 6: Evaluation Board Parts List

ITEM	DESCRIPTION	QTY	VENDOR	VENDOR P/N
C1,C2,C5,C6	0.01uF. CHIP CAP.	4	MURATA	GRM39X7R1103K25V
C3,C4	470 pF. CHIP CAP.	2	MURATA	GRM47X7R301K25V
C7	47 uF ELECT.CAP.	1	DIGI-KEY CORP.	P5275-ND
C9	NOT USED			
L1,L2	470 nH CHIP IND.	2	MURATA	LQH1NR47KONOO-03/4052
T1,T2- BALUN	CORE	2	Fair-Rite	2843002702
	WIRE		MWS Wire Ind.	T-2361429-20
R1 ⁽⁴⁾	2 k Ω 5.2 k Ω	1	Panasonic	ERJ-3EKF2001V ERJ-3EKF5231V
TVS	TVS 12 VOLT. 600 WATT	1	DIGI-KEY CORP.	SMBJ12ACCCT-ND
CONNECTOR	75 Ω N MALE PANEL MOUNT.	2	PASTERNAK ENTERP.	PE4504
	PRINTED CIRCUIT BOARD	1		
INDIUM	300 x 160 MILS	1	INDIUM CORP. OF AMERICA	14996Y

Notes:

1. T1, T2 (balun) wind 4 turns thru core as shown. (Figure 28).
2. "N" connector, center pin, should be approximately 80 mils in length.
3. Due to the high power dissipation of this device the PC board should be mounted/ attached to a large heat sink.
- (4) See Table 5.

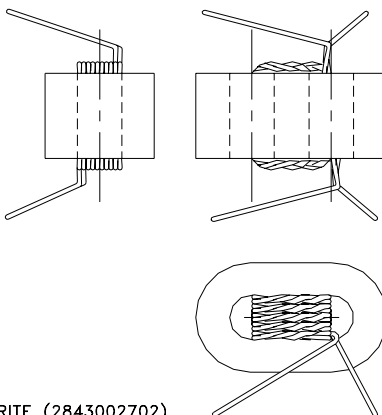

NOTES:

1. MATERIAL:

CORE: FAIR-RITE (2843002702)
 WIRE: MWS WIRE IND.
 T-2361429-20
 5.5 TIMES THRU AS SHOWN.

DIMENSIONS ARE IN INCHES

Figure 28: Balun Drawing

PACKAGE OUTLINE

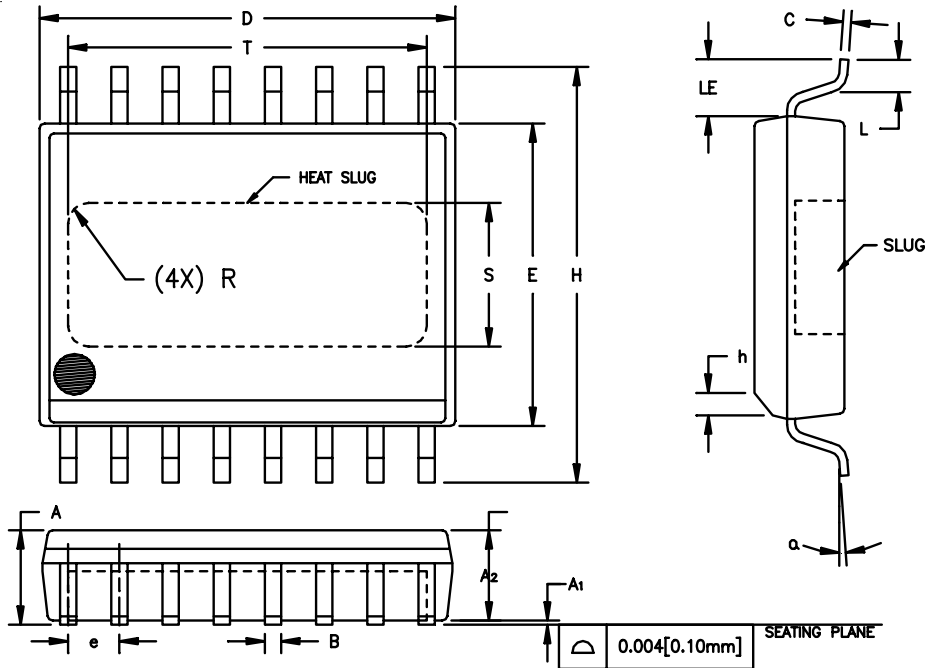

	INCHES		MILLIMETERS		NOTE
	MIN.	MAX.	MIN.	MAX.	
A	0.087	0.098	2.21	2.49	
A ₁	0.000	0.004	0.00	0.10	6
A ₂	0.087	0.094	2.21	2.39	
B	0.013	0.019	0.33	0.48	
C	0.007	0.009	0.18	0.23	
D	0.398	0.412	10.11	10.46	2
E	0.290	0.300	7.37	7.62	3
e	0.050 BSC		1.27 BSC		4
H	0.394	0.418	10.01	10.62	
h	0.010	0.028	0.25	0.71	
L	0.024	0.040	0.61	1.02	
LE	0.052	—	1.32	—	
q	0°	8°	0°	8°	
S	0.120	0.140	3.05	3.56	5
T	0.330	0.350	8.38	8.89	5
R	REF. 0.015		REF. 0.38		5

NOTES:

1. CONTROLLING DIMENSION: INCHES
2. DIMENSION "D" DOES NOT INCLUDE MOLD FLASH, PROTRUSIONS OR GATE BURRS. MOLD FLASH, PROTRUSIONS AND GATE BURRS SHALL NOT EXCEED 0.006 [0.15mm] PER SIDE.
3. DIMENSION "E" DOES NOT INCLUDE INTER-LEAD FLASH OR PROTRUSIONS. INTER-LEAD FLASH AND PROTRUSIONS SHALL NOT EXCEED 0.010 [0.25mm] PER SIDE.
4. MAXIMUM LEAD TWIST/SKEW TO BE ±0.005 [0.13mm].
5. DIMENSIONS "S", "T" AND "R" INDICATE EXPOSED SLUG AREA.
6. STANDOFF HEIGHT (A₁) MEASURED FROM BOTTOM OF SLUG.

Figure 29: S7 Package Outline - 16 Pin Wide Body SOIC with Heat Slug

NOTES

ORDERING INFORMATION

ORDER NUMBER	TEMPERATURE RANGE	PACKAGE DESCRIPTION	COMPONENT PACKAGING
ACA1206RS7P2	-40°C to 110°C	RoHS-Compliant 16 Pin Wide Body SOIC with Heat Sink	1,500 Piece Tape & Reel

**ANADIGICS, Inc.**

141 Mount Bethel Road
Warren, New Jersey 07059, U.S.A.

Tel: +1 (908) 668-5000

Fax: +1 (908) 668-5132

URL: <http://www.anadigics.com>

E-mail: Mktg@anadigics.com

IMPORTANT NOTICE

ANADIGICS, Inc. reserves the right to make changes to its products or to discontinue any product at any time without notice. The product specifications contained in Advanced Product Information sheets and Preliminary Data Sheets are subject to change prior to a product's formal introduction. Information in Data Sheets have been carefully checked and are assumed to be reliable; however, ANADIGICS assumes no responsibilities for inaccuracies. ANADIGICS strongly urges customers to verify that the information they are using is current before placing orders.

WARNING

ANADIGICS products are not intended for use in life support appliances, devices or systems. Use of an ANADIGICS product in any such application without written consent is prohibited.