



## Product Specifications

**15.0" XGA Color TFT-LCD Module**  
**Model Name: L150X2M-1**  
**EC: -4**

( ) Preliminary Specifications  
(◆) Final Specifications

## i Contents

(C) Copyright Acer Display Technology, Inc.

Apr. , 2001 All Rights Reserved.

No Reproduction and Redistribution Allowed.

L150X2M-1 EC :-4 Ver0.3

1/23

www.DataSheet4U.com

## **1.0 Handling Precautions**

## **2.0 General Description**

- 2.1 Display Characteristics
- 2.2 Functional Block Diagram
- 2.3 Optical Characteristics
- 2.4 Pixel format image

## **3.0 Electrical characteristics**

- 3.1 Absolute Maximum Ratings
- 3.2 Module Interface Connectors
  - 3.2.1 Connector Type
  - 3.2.2 Pin Configuration
- 3.3 Backlight Connector
  - 3.3.1 Connector Type
  - 3.3.2 Pin Configuration
- 3.4 Signal Electrical Characteristics
- 3.5 Interface Timing
  - 3.5.1 Timing Characteristic
  - 3.5.2 Timing Definition
- 3.6 Power Consumption
- 3.7 Power ON/OFF Sequence

## **4.0 Backlight Characteristics**

- 4.1 Signal for Lamp connector
- 4.2 Parameter guideline for CCFL Inverter

## **5.0 Label, Vibration, Shock, and Drop**

- 5.1 Label
- 5.2 Vibration and shock
- 5.3 Drop test

## **6.0 Environment**

- 6.1 Temperature and humidity
  - 6.1.1 Operating conditions
  - 6.1.2 Shipping conditions
- 6.2 Atmospheric pressure
- 6.3 Thermal shock

## **7.0 Reliability**

- 7.1 Failure criteria
- 7.2 Failure rate
  - 7.2.1 Usage
  - 7.2.2 Components de-rating
- 7.3 CCFL life
- 7.4 ON/OFF cycle

## **8.0 Safety**

- 8.1 Sharp edge requirement
- 8.2 Material
  - 8.2.1 Toxicity
  - 8.2.2 Flammability
- 8.3 Capacitors
- 8.4 Hazardous voltage

## **9.0 Other requirements**

(C) Copyright Acer Display Technology, Inc.

Apr. , 2001 All Rights Reserved.

L150X2M-1 EC :-4 Ver0.3

No Reproduction and Redistribution Allowed.

2/23

www.DataSheet4U.com

- 9.1 Smoke free design
- 9.2 National test lab requirement

## 10.0 Mechanical Characteristics

### ii Record of Revision

www.DataSheet4U.com

Version and Date	Page	Old description	New Description	Remark
0.1 2001/04/12	All	First Edition for Customer	All	
0.2 2001/4/18	9	<b>Color / Chromaticity :</b> Wx = 0.313 ± 0.03 Wy = 0.329 ± 0.03 Rx = 0.633 ± 0.03 Ry = 0.336 ± 0.03 Gx = 0.294 ± 0.03 Gy = 0.614 ± 0.03 Bx = 0.145 ± 0.03 By = 0.097 ± 0.03	<b>Color / Chromaticity :</b> Wx = 0.313 ± 0.03 Wy = 0.329 ± 0.03 Rx = 0.61 ± 0.03 Ry = 0.34 ± 0.03 Gx = 0.32 ± 0.03 Gy = 0.57 ± 0.03 Bx = 0.15 ± 0.03 By = 0.11 ± 0.03	Change
0.3 2001/5/11	5	Brightness : 200(typ)@6.5mA, 240 (typ.)@8mA Contrast : 300 Response Time : 35ms(typ) Viewing Angle : 60/60/40/60 (typ)	Brightness : 200(typ)@6.5mA, 250 (typ.)@8mA Contrast : 350 Response Time : 30ms(typ) Viewing Angle : 75/75/70/70 (typ)	Change
	8	White Luminance : 240nit (typ.)@8mA Contrast : 200(min), 300(typ)	Brightness : 250nit (typ.)@8mA Contrast : 250(min), 350(typ)	Change
	8	Viewing Angle at CR=10 : L/R/U/D : 60/60/40/60 (typ) L/R/U/D : 50/50/30/50(min)	Viewing Angle at CR=10 : L/R/U/D : 75/75/70/70 (typ) L/R/U/D : 65/65/60/60(min)	Add
	8	Response Time : 35ms(typ), 70ms(max) Rising Time Ton : 11ms(typ), 22ms(max) Falling Time Toff : 24ms(typ), 48ms(max)	Response Time : 30ms(typ), 60ms(max) Rising Time Ton : 8ms(typ), 16ms(max) Falling Time Toff : 22ms(typ), 44ms(max)	Change
0.3 2001/5/11	22	Old ME Backlight Drawing-Front View	New ME Backlight Drawing-Front View	Change
	23	Old ME Backlight Drawing-Rear View	New ME Backlight Drawing-Rear View	Change

## 1.0 Handling Precautions

(C) Copyright Acer Display Technology, Inc.

Apr. , 2001 All Rights Reserved.

L150X2M-1 EC :-4 Ver0.3

No Reproduction and Redistribution Allowed.

3/23

www.DataSheet4U.com

- 1) Since front polarizer is easily damaged, pay attention not to scratch it.
- 2) Be sure to turn off power supply when inserting or disconnecting from input connector.
- 3) Wipe off water drop immediately. Long contact with water may cause discoloration or spots.
- 4) When the panel surface is soiled, wipe it with absorbent cotton or other soft cloth.
- 5) Since the panel is made of glass, it may break or crack if dropped or bumped on hard surface.
- 6) Since CMOS LSI is used in this module, take care of static electricity and insure human earth when handling.
- 7) Do not open nor modify the Module Assembly.
- 8) Do not press the reflector sheet at the back of the module to any directions.
- 9) At the insertion or removal of the Signal Interface Connector, be sure not to rotate nor tilt the Interface Connector of the TFT-LCD module.
- 10) After installation of the TFT-LCD module into an enclosure (LCD monitor housing, for example), do not twist nor bend the TFT-LCD Module even momentary. At designing the enclosure, it should be taken into consideration that no bending/twisting forces are applied to the TFT-LCD module from outside. Otherwise the TFT-LCD module may be damaged.

## 2.0 General Description

This specification applies to the 15.0 inch Color TFT-LCD Module L150X2M-1.

The display supports the XGA (1024(H) x 768(V)) screen format and 256K colors (RGB 6-bits data).

All input signals are 2 Channel TTL interface compatible.

This module does not contain an inverter card for backlight.

## 2.1 Display Characteristics

The following items are characteristics summary on the table under 25 °C condition:

ITEMS	Unit	SPECIFICATIONS
Screen diagonal	[mm]	381 (15")
Outline dimension	[mm]	336.0(W)x249.0(H)x13.5(D)( typ.)
Display Area	[mm]	304.128 (H) x 228.096(V)
Resolution		1024(R,G,B x 3) x 768
Pixel Pitch	[mm]	0.297 x 0.297
Pixel Arrangement		R.G.B. Vertical Stripe
Display Mode		TN mode, Normally White
Brightness	[cd/m <sup>2</sup> ]	200(typ.)@6.5mA, 250 (typ.)@8mA
Brightness uniformity		80% (typ.) (note 2)
Luminance uniformity (TCO99)		1.7 (max.) (note 3)
Crosstalk		1.2% (max.) (note 4)
Contrast Ratio		350 : 1 (typ.)
Support color		262 K colors (6-bit for R,G,B)
Color Gamut		55% (typ.)
Viewing angle		75(left),75(right),70(up),70(down)
Response Time	[msec]	30 (typ.)(Tr +Tf)
Nominal Input Voltage VDD	[Volt]	+3.3 V
Power Consumption (VDD line + CCFL line)	[Watt]	14 (typ.)
Electrical Interface		TTL 2 port (HSYNC,VSYNC,DCLK,DE,DATA)
Frame rate	[Hz]	60 (typ), 75 (max.)
Weight	[Grams]	1200 (typ.)
Temperature Range		
Operating	[°C]	0 to +50
Storage (Shipping)	[°C]	-20 to +60

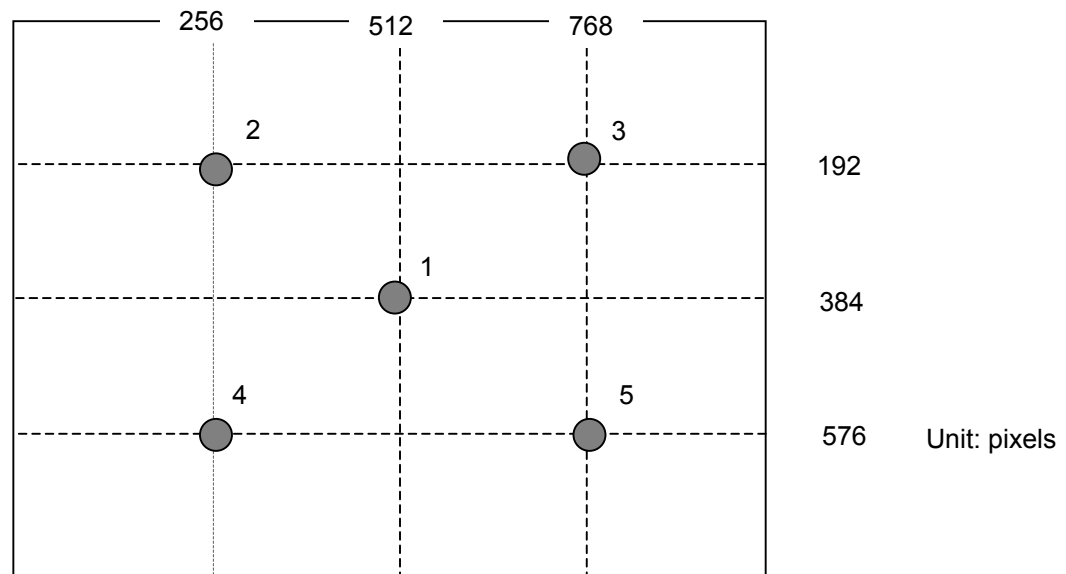

Note 1: Average brightness is the average of brightness value at location 1 to 5 with all pixels displaying white.  
(C) Copyright Acer Display Technology, Inc.

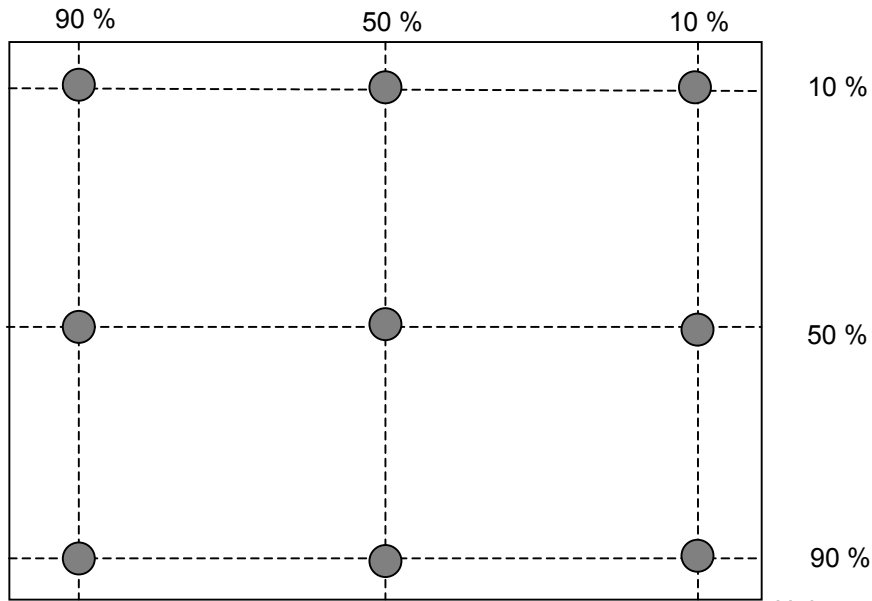

Unit: percentage of dimension of display area

Note 2: Brightness uniformity of these 9 points is defined as below:

$$(\text{Min. brightness} / \text{Max. brightness}) \times 100\%$$

Note 3: TCO '99 Certification Requirements and test methods for environmental labeling of Display Report No. 2 defines Luminance uniformity as below:

$$((L_{\text{max},+30\text{deg.}} / L_{\text{min},+30\text{deg.}}) + (L_{\text{max},-30\text{deg.}} / L_{\text{min},-30\text{deg.}})) / 2$$

Note 4:

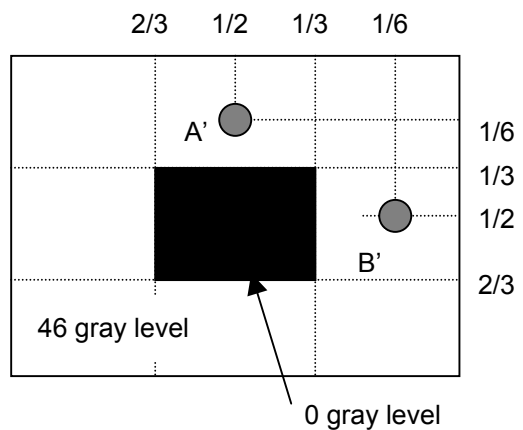
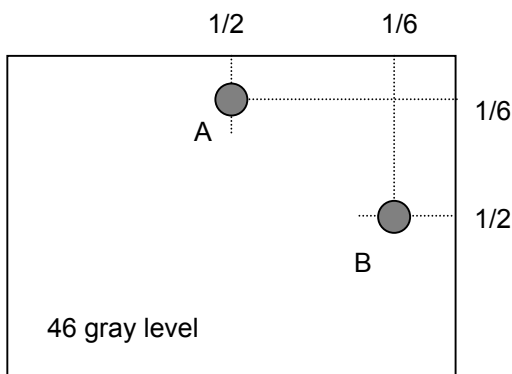

Unit: percentage of dimension of display area

$$|L_A - L_{A'}| / L_A \times 100\% = 1.2\% \text{ max.}, L_A \text{ and } L_B \text{ are brightness at location A and B}$$

$$|L_B - L_{B'}| / L_B \times 100\% = 1.2\% \text{ max.}, L_{A'} \text{ and } L_{B'} \text{ are brightness at location A' and B'}$$

## 2.2 Functional Block Diagram

The following diagram shows the functional block of 15.0 inches Color TFT-LCD Module:

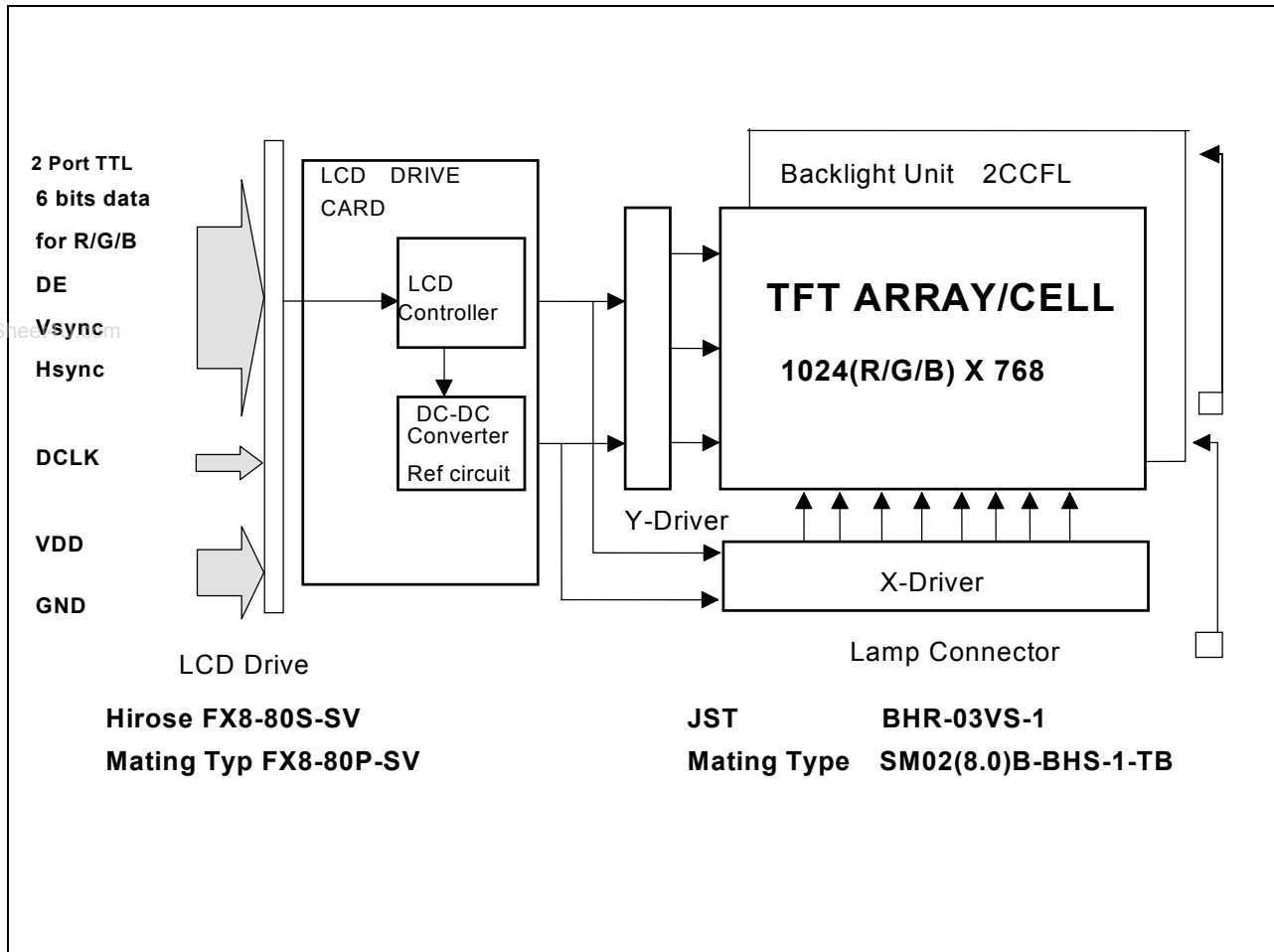

## 2.3 Optical Characteristics

The optical characteristics are measured under stable conditions at 25°C (Room Temperature):

Item	Unit	Conditions	Min.	Typ.	Max.
Viewing Angle CR: Contrast Ratio	[degree]	Horizontal (Right)	65	75	
	[degree]	CR = 10 (Left)	65	75	
	[degree]	Vertical (Up)	60	70	
	[degree]	CR = 10 (Down)	60	70	
Contrast ratio		Normal Direction	250	350	-
Response Time	[msec]	Rising Time Ton ( 10%-90% )	-	8	16
	[msec]	Falling Time Toff ( 90%-10% )	-	22	44
	[msec]	Rising + Falling	-	30	60
Color / Chromaticity Coordinates (CIE)		Red x	0.58	0.61	0.64
		Red y	0.31	0.34	0.37
		Green x	0.29	0.32	0.35
		Green y	0.54	0.57	0.60
		Blue x	0.12	0.15	0.18
		Blue y	0.08	0.11	0.14
Color Coordinates (CIE) White		White x	0.283	0.313	0.343
		White y	0.299	0.329	0.359
Brightness Uniformity	[%]		75	80	-
Brightness at CCFL 8.0mA	[cd/m <sup>2</sup> ]		200	250	-
Brightness at CCFL 6.5mA			160	200	-



## 2.4 Pixel format image

Following figure shows the relationship of the input signals and LCD pixel format.

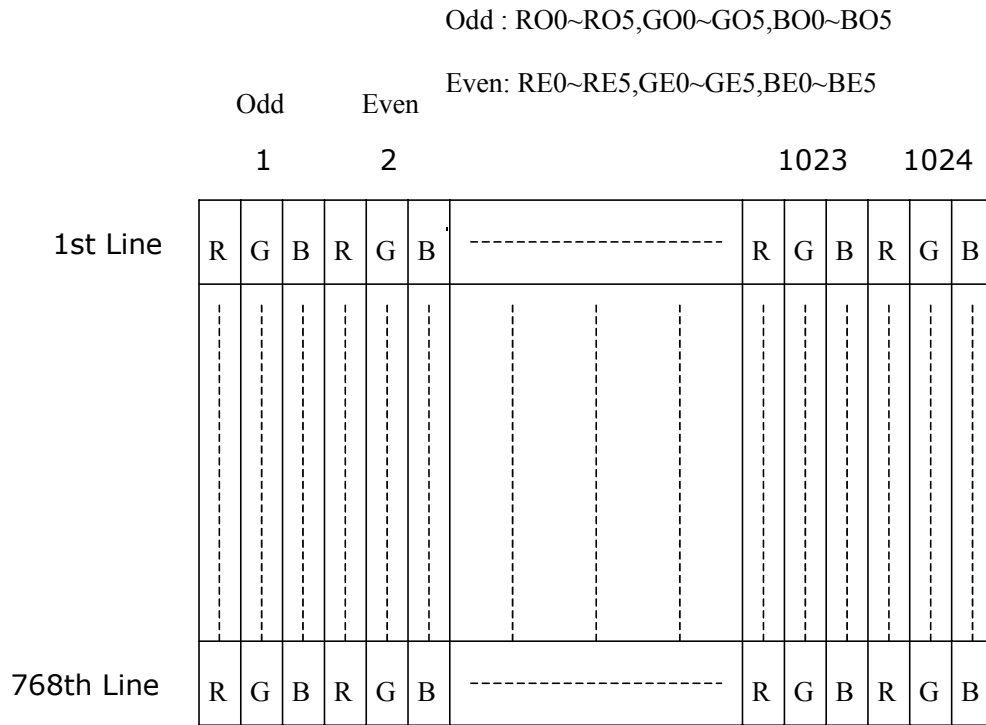

www.DataSheet4U.com

## 3.0 Electrical characteristics

### 3.1 Absolute Maximum Ratings

Absolute maximum ratings of the module is as following:

Item	Symbol	Min	Max	Unit	Conditions
Logic/LCD Drive Voltage	VDD	-0.3	+4.0	[Volt]	
CCFL Inrush current	ICFLL	-	20	[mA]	Note 1
CCFL Current	ICFL	-	8.0	[mA] rms	
Operating Temperature	TOP	0	+50	[°C]	Note 2
Operating Humidity	HOP	20	85	[%RH]	Note 2
Storage Temperature	TST	-20	+60	[°C]	Note 2
Storage Humidity	HST	5	95	[%RH]	Note 2

**Note 1 :** Duration=50 msec

**Note 2 :** Maximum Wet-Bulb should be 39°C and No condensation.

### 3.2 Module Interface Connectors

#### 3.2.1 Connector type

<b>Connector Name</b>	Interface Connector
<b>Manufacturer</b>	Hirose or compatible
<b>Type / Part Number</b>	FX8-80S-SV
<b>Mating Housing/Part Number</b>	FX8-80P-SV

#### 3.2.2 Pin Configuration

Pin No.	Symbol	Description	Pin No.	Symbol	Description
1	GND	Ground	41	GND	Ground
2	GND	Ground	42	GND	Ground
3	GND	Ground	43	GND	Ground
4	RO0	Red data 0(odd)	44	GE0	Green data 0(even)
5	RO1	Red data 1(odd)	45	GE1	Green data 1(even)
6	GND	Ground	46	GND	Ground
7	RO2	Red data 2(odd)	47	GE2	Green data 2(even)
8	RO3	Red data 3(odd)	48	GE3	Green data 3(even)
9	RO4	Red data 4(odd)	49	GE4	Green data 4(even)
10	RO5	Red data 5(odd),MSB	50	GE5	Green data 5(even),MSB
11	GND	Ground	51	GND	Ground
12	GND	Ground	52	GND	Ground

13	GND	Ground	53	GND	Ground
14	GO0	Green data 0(odd)	54	BE0	Blue data 0(even)
15	GO1	Green data 1(odd)	55	BE1	Blue data 1(even)
16	GND	Ground	56	GND	Ground
17	GO2	Green data 2(odd)	57	BE2	Blue data 2(even)
18	GO3	Green data 3(odd)	58	BE3	Blue data 3(even)
19	GO4	Green data 4(odd)	59	BE4	Blue data 4(even)
20	GO5	Green data 5(odd),MSB	60	BE5	Blue data 5(even),MSB
21	GND	Ground	61	GND	Ground
22	GND	Ground	62	GND	Ground
23	GND	Ground	63	DCLK	Data input clock
24	BO0	Blue data 0(odd)	64	GND	Ground
25	BO1	Blue data 1(odd)	65	GND	Ground
26	GND	Ground	66	HSYNC	Horizontal sync signal
27	BO2	Blue data 2(odd)	67	GND	Ground
28	BO3	Blue data 3(odd)	68	GND	Ground
29	BO4	Blue data 4(odd)	69	DE	Data enable signal
30	BO5	Blue data 5(odd),MSB	70	VSYNC	Vertical sync signal
31	GND	Ground	71	VDD	Power supply +3.3V
32	GND	Ground	72	VDD	Power supply +3.3V
33	GND	Ground	73	VDD	Power supply +3.3V
34	RE0	Red data 0(even)	74	VDD	Power supply +3.3V
35	RE1	Red data 1(even)	75	VDD	Power supply +3.3V
36	GND	Ground	76	NC	No connection
37	RE2	Red data 2(even)	77	NC	No connection
38	RE3	Red data 3(even)	78	NC	No connection
39	RE4	Red data 4(even)	79	NC	No connection
40	RE5	Red data 5(even),MSB	80	GND	Ground

### 3.3 Backlight Connectors

#### 3.3.1 Connector type

<b>Connector Name / Designation</b>	For Lamp Connector
<b>Manufacturer</b>	JST or compatible
<b>Type / Part Number</b>	BHR-03VS-1 (JST) or equivalent
<b>Mating Type / Part Number</b>	SM02(8.0)B-BHS-1-TB or equivalent

### 3.3.2 Pin Configuration

Pin	Symbol	Description
1	HV	Lamp High Voltage
2	NC	No connection
3	LV	Ground

### 3.4 Signal Electrical Characteristics

Each signal characteristics are as follows;

Item	Symbol	Min	Typ	Max	Unit
LCD Drive voltage	VDD	+3.0	+3.3	+3.6	[V]
“High” input signal voltage	Vih	2.0	-	-	[V]
“Low” input signal voltage	Vil	-	-	0.8	[V]

### 3.5 Interface Timings

#### 3.5.1 Timing Characteristics

Signal	Item	Symbol	MIN	TYP	MAX	Unit
DCLK	Frequency	1/TDCLK	-	32.5	40.0	MHz
	Period	TDCLK	25	30.8	-	ns
	High time	TCH	0.4	0.5	0.6	TDCLK
	Low time	TCL	0.4	0.5	0.6	TDCLK
DATA	Setup time	TDS	5	-	-	ns
	Hold time	TDH	5	-	-	ns
Data Enable	Setup time	TES	5	-	-	ns
	Hold time	TEH	5	-	-	ns
Horizontal sync	Frequency	1/TH	-	48	60	KHz
	Pulse width	THP	2	68	-	TDCLK
Horizontal Signal	Back –porch	THB	1	80	-	TDCLK
	Display period	THD	512	512	512	TDCLK
	Front-porch	THF	0	12	-	TDCLK
	H total	TH	600	672	-	
Vertical sync	Frequency	1/TV	-	60	75	Hz
	Pulse width	TVP	1	6	-	TH
Vertical Signal	Back-porch	TVB	7	29	64	TH
	Display period	TVD	768	768	768	TH
	Front-porch	TVF	1	3	-	TH
	Vsync period + Vback-porch	TVP+TVB	5	-	15	

### 3.5.2 Timing Definition

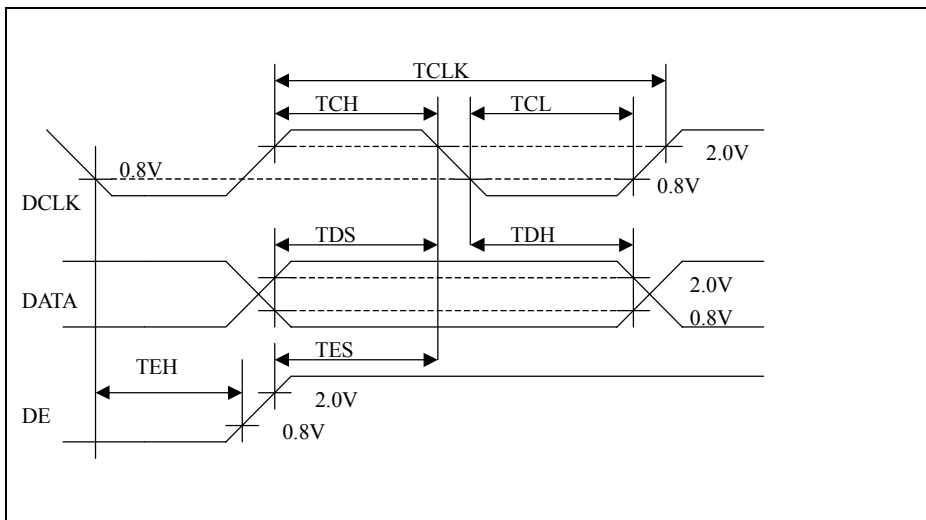
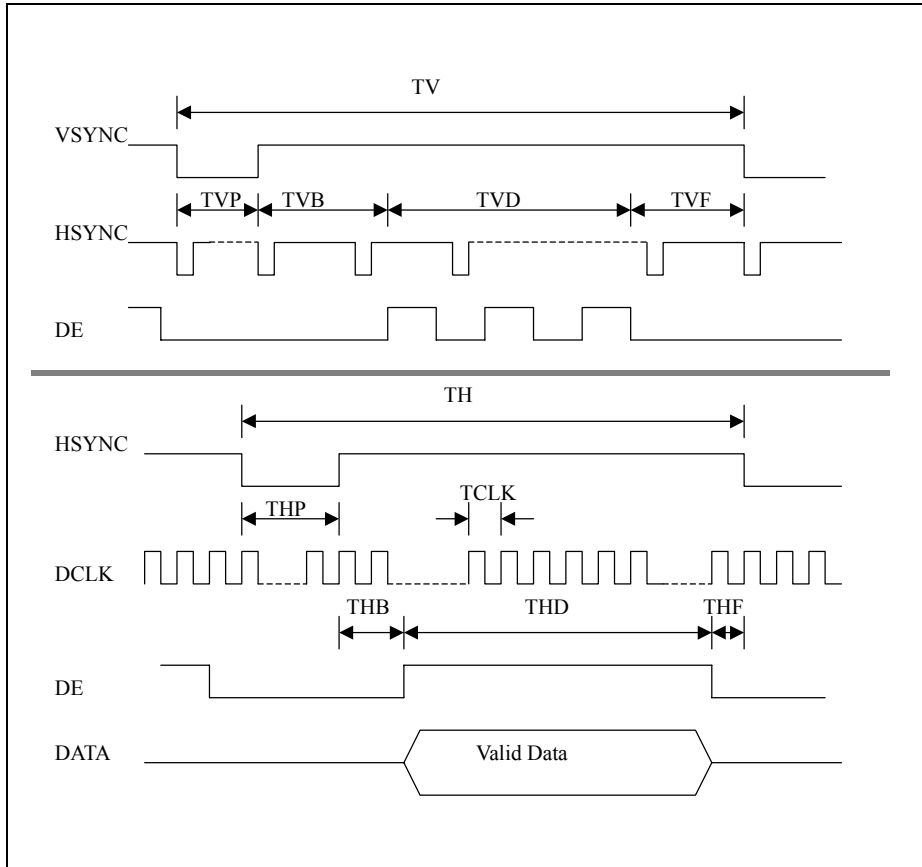

### 3.6 Power Consumption

Input power specifications are as follows;

Symbol	Parameter	Min	Typ	Max	Units	Condition
VDD	LCD Drive Voltage	3.0	3.3	3.6	[V]	
IDD	LCD Drive Current	-	600	700	[mA]	
PDD	LCD Drive power consumption	-	2	2.4	[Watt]	VDD=3.3v, All Black Pattern
VDDrp	Allowable LCD Drive Ripple Voltage			100	[mV] p-p	
VDDns	Allowable LCD Drive Ripple Noise			100	[mV] p-p	

### 3.7 Power ON/OFF Sequence

VDD power and lamp on/off sequence is as follows. Interface signals are also shown in the chart.

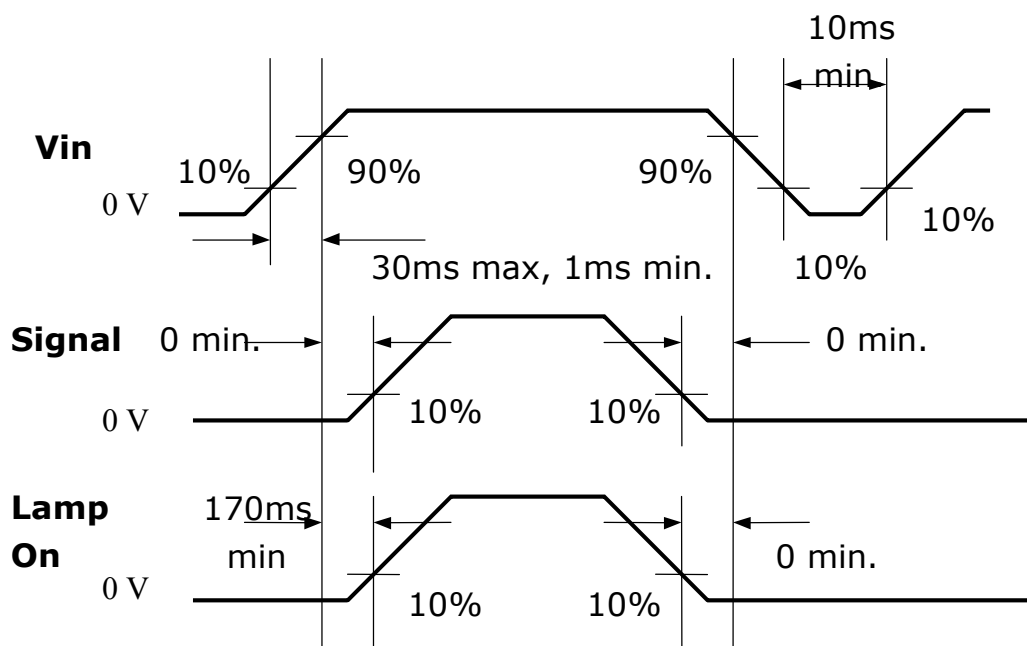

## 4.0 Backlight Characteristics

### 4.1 Signal for Lamp connector

Pin #	signal Name
1	Lamp High Voltage
2	No connection
3	Ground

### 4.2 Parameter guide line for CCFL Inverter

Symble	Parameter	Min□	Typ	Max□	Units	Condition
(L255)	Brightness		250 @ 8.0mA	-	[cd/m <sup>2</sup> ]	(Ta=25°C)
(L255)	Brightness		200 @ 6.5mA	-	[cd/m <sup>2</sup> ]	(Ta=25°C)
IRCFL	CCFL operation range	3.0	6.5	8.0	[mA] rms	(Ta=25°C)
ICFL	CCFL Inrush current	-	-	20	[mA]	<b>Note 1</b>
fCFL	CCFL Frequency	40	55	60	[KHz]	(Ta=25°C) <b>Note 2</b>
ViCFL (25°C) (reference)	CCFL Ignition Voltage	1000			[Volt] rms	(Ta= 25°C) <b>Note 4</b>
VCFL	CCFL Discharge Voltage (Reference)		630	690	[Volt] rms	(Ta=25°C) <b>Note 3</b>
PCFL	CCFL Power consumption @ 6.5mA (excluding inverter)		8.2	10	[Watt]	(Ta=25°C) <b>Note 3</b>

Note 1: Duration=50 [msec]

Note 2: CCFL Frequency should be carefully determined to avoid interference between inverter and TFT LCD

Note 3: Calculator value for reference (ICFL×VCFL=PCFL)

Note 4: CCFL inverter should be able to give out a power that has a generating capacity of over 1000 voltage.  
Lamp units need 1000 voltage minimum for ignition

## 5.0 Label, Vibration, Shock, and Drop

### 5.1 Label

Unit mark is printed on a label. The label is shown as below:

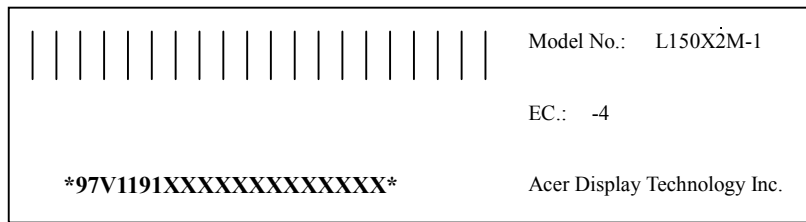

Model No: L150X2M-1

EC: -4

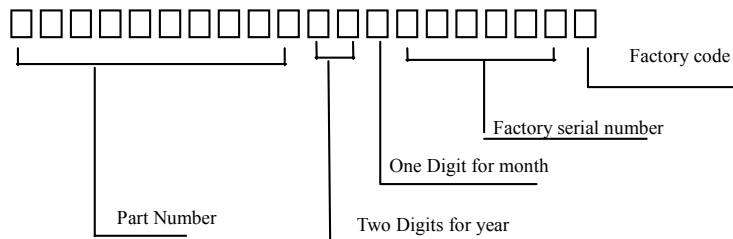

Serial No:

Factory Code: H: HsinChu, L : Lungtan

Year	Mark
1997	97
1998	98
1999	99
2000	00
2001	01
2002	02

Month	Mark	Month	Mark
1	1	7	7
2	2	8	8
3	3	9	9
4	4	10	A
5	5	11	B
6	6	12	C

CARTON NO:

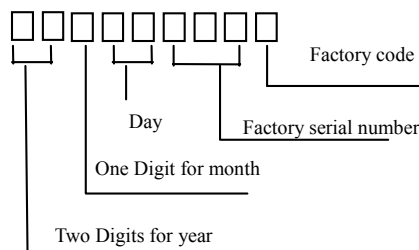



## 5.2 Vibration & Shock

The module shall work error free after following vibration and shock condition. Likewise the module shall not sustain any damage after vibration and shock test.

### 5.2.1 Vibration Test Spec:

- Frequency: 10 - 200Hz
- Sweep: 30 Minutes each Axis (X, Y, Z)
- Acceleration: 1.5G(10~200Hz P- P)

www.DataSheet4U.com Test method:

<b>Acceleration (G)</b>	1.5
<b>Frequency (Hz)</b>	10~200~10
<b>Active time(min)</b>	30

### 5.2.2 Shock Test Spec:

<b>Acceleration (G) -a</b>	50
<b>Active time(ms) -b</b>	20
<b>Wave form</b>	half-sin
<b>Times</b>	1

- Direction:  $\pm X$ ,  $\pm Y$ ,  $\pm Z$

## 5.3 Drop

Package test: The drop height is defined as 60 cm.

## 6.0 Environment

The display module will meet the provision of this specification during operating condition or after storage or shipment condition specified below. Operation at 10% beyond the specified range will not cause physical damage to the unit.

### 6.1 Temperature and Humidity

#### 6.1.1 Operating Conditions

The display module operates error free, when operated under the following conditions;

Temperature	0 °C to 50 °C
Relative Humidity	20% to 85%
Wet Bulb Temperature	39.0 °C

#### 6.1.2 Shipping Conditions

The display module operates error free, after the following conditions;

Temperature	-20 °C to 60 °C
Relative Humidity	5% to 95%
Wet Bulb Temperature	39.0 °C

### 6.2 Atmospheric Pressure

The display assembly is capable of being operated without affecting its operations over the pressure range as following specified:

	Pressure	Altitude
Maximum Pressure	1040 hPa	0 m = sea level
Minimum Pressure	601 hPa	3658 m = 12,000 feet

Note: Non-operation altitude limit of this display module = 40,000 feet. = 12193 m.

### 6.3 Thermal Shock

The display module will not sustain damage after being subjected to 100 cycles of rapid temperature change. A cycle of rapid temperature change consists of varying the temperature from -20°C to 60°C, and back again.

<b>Thermal shock cycle</b>	-20 °C for 30min 60 °C for 30min
----------------------------	-------------------------------------

Power is not applied during the test. After temperature cycling, the unit is placed in normal room ambient for at least 4 hours before powering on.

## 7.0 Reliability

This display module and the packaging of that will comply following standards.

### 7.1 Failure Criteria

The display assembly will be considered as failing unit when it no longer meets any of the requirements stated in this specification. Only as for maximum white luminance, following criteria is applicable.

- **Maximum white Luminance shall be 75 cd/m<sup>2</sup> or more.**

### 7.2 Failure Rate

The average failure rate of the display module (from first power-on cycle till 1,000 hours later) will not exceed 1.0%. The average failure rate of the display module from 1,000 hours until 10,000 hours will not exceed 0.70% per 1000 hours.

#### 7.2.1 Usage

The assumed usage for the above criteria is:

- 220 power-on hours per month
- 500 power on/off cycles per month
- Maximum brightness setting
- Operation to be within office environment (25°C typical)

#### 7.2.2 Component De-rating

All the components used in this device will be checked the load condition to meet the failure rate criteria.

### 7.3 CCFL Life

The assumed CCFL Life will be longer than 50,000 hours under stable condition at 25±5 °C;

Standard current at 6.0±0.5 mA

Definition of life: brightness becomes 50% or less than the minimum luminance value of CCFL.

### 7.4 ON/OFF Cycle

The display module will be capable of being operated over the following ON/OFF Cycles.

ON/OFF	Value	Cycle
+VDD and CCFL power	36,000	10 seconds on / 10 seconds off

## 8.0 Safety

### 8.1 Sharp Edge Requirements

There will be no sharp edges or corners on the display assembly that could cause injury.

### 8.2 Materials

#### 8.2.1 Toxicity

There will be no carcinogenic materials used anywhere in the display module. If toxic materials are used, they will be reviewed and approved by the responsible ADT Toxicologist.

#### 8.2.2 Flammability

All components including electrical components that do not meet the flammability grade UL94-V1 in the module will complete the flammability rating exception approval process. The printed circuit board will be made from material rated 94-V1 or better. The actual UL flammability rating will be printed on the printed circuit board.

### 8.3 Capacitors

If any polarized capacitors are used in the display assembly, provisions will be made to keep them from being inserted backwards.

### 8.4 Hazardous Voltages

Any point exceeding 42.4 volts meets the requirement of the limited current circuit. The current through a  $2K\Omega$  resistance is less than  $0.7 \times f$  (kHz) mA.

## 9.0 Other requirements

### 9.1 Smoke Free Design

By any single failure, any smoke nor strange smell shall not be observed by the operator.

### 9.2 National Test Lab Requirement

The display module will satisfy all requirements for compliance to the following requirement:

<b>UL 1950, First Edition</b>	U.S.A. Information Technology Equipment
<b>CSA C22.2 No.950-M89</b>	Canada, Information Technology Equipment
<b>IEC 950</b>	International, Information Technology Equipment
<b>EN 60 950</b>	International, Information Processing Equipment (European Norm for IEC950)

The construction of the display module is designed to suppress EMI. When mounted into a specified host system, the system will meet the following EMI requirement:

**FCC Part 15 Class B**  
**VCCI Class 2**  
**CISPR 22, class B**  
**Taiwan CNS standard**  
**China CCIB standard**

## 10.0 Mechanical Characteristics

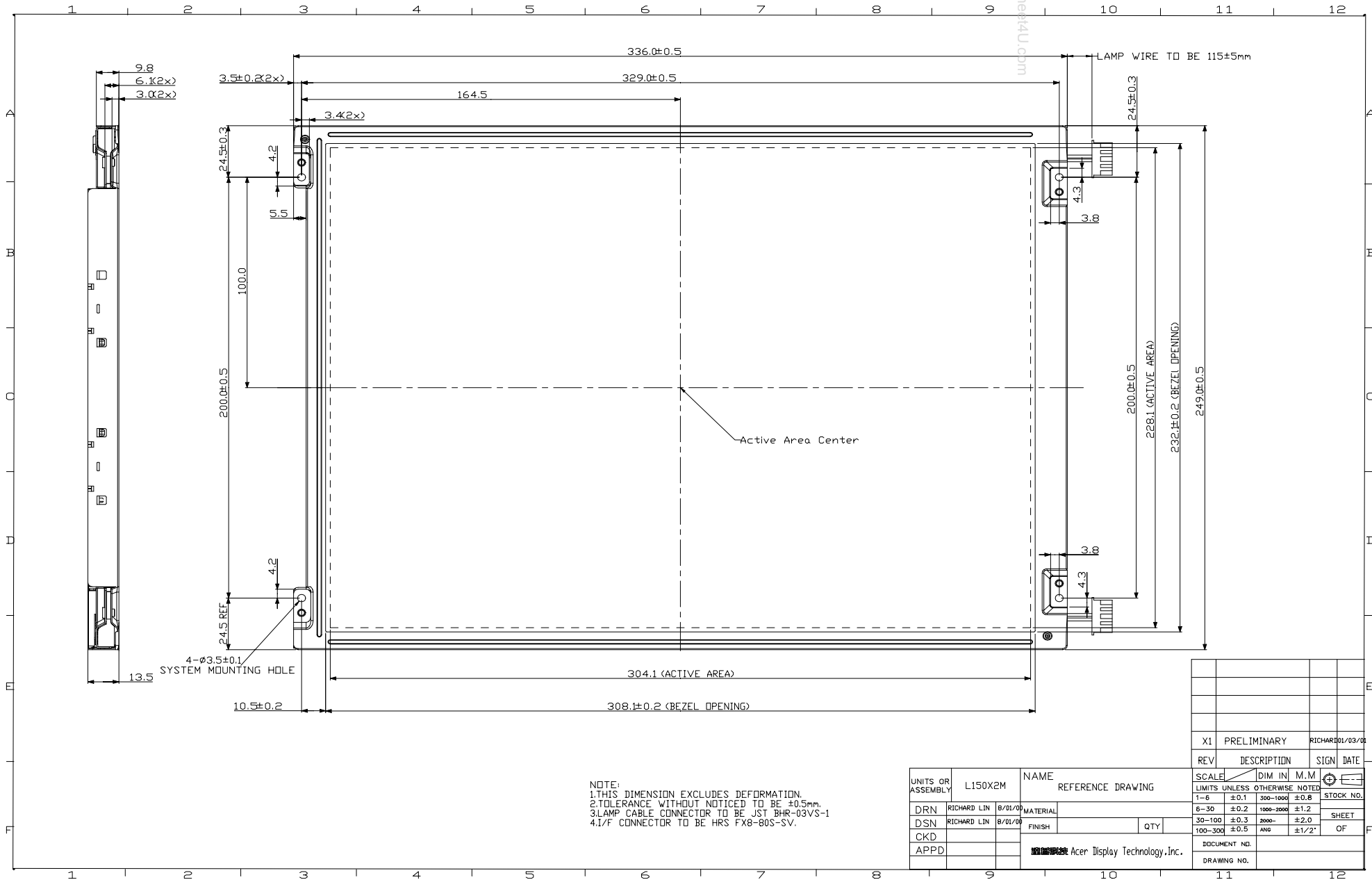

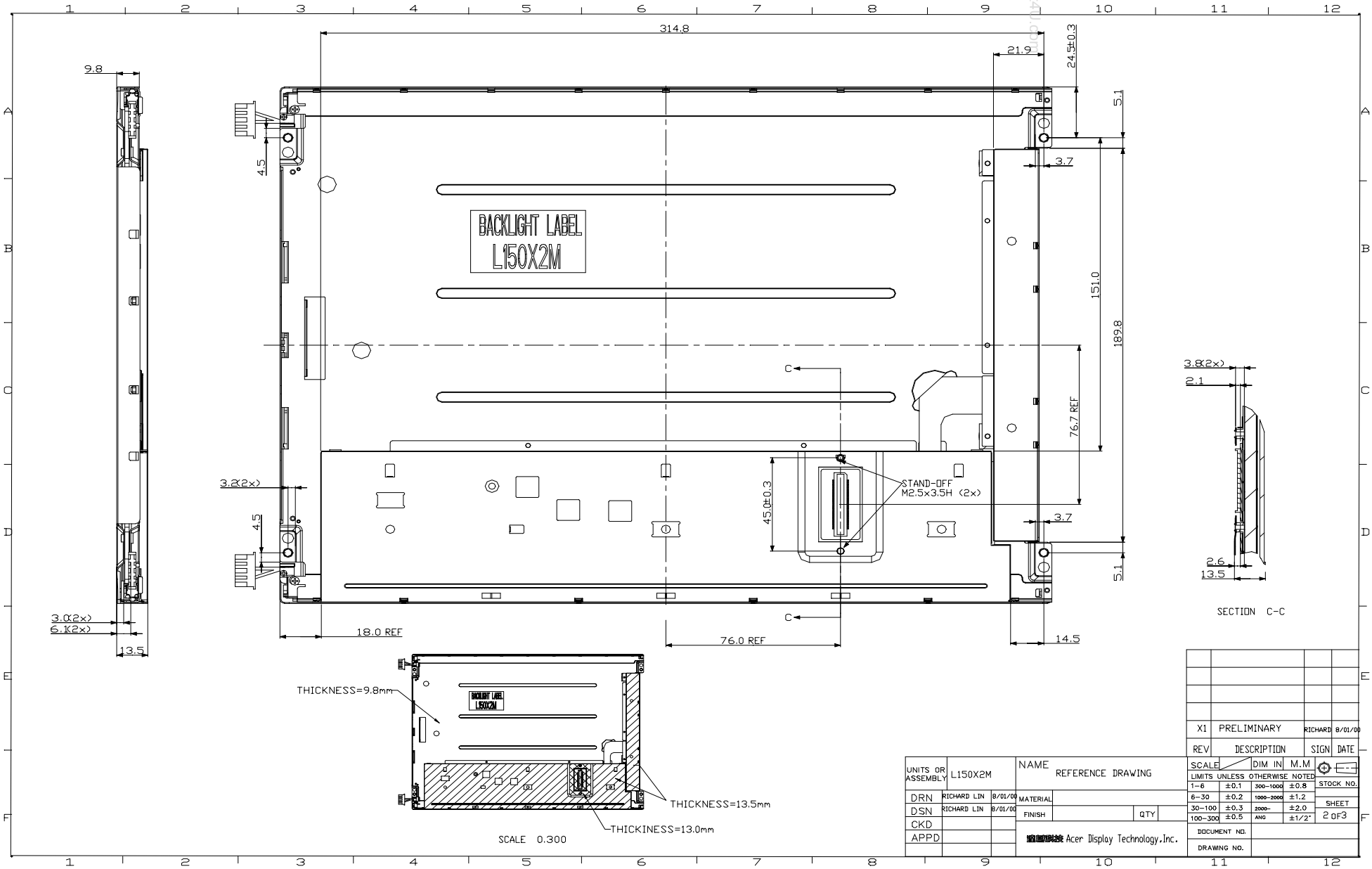

REV	DESCRIPTION	SIGN	DATE
X1	PRELIMINARY	RICHARD	8/01/00

UNITS OR ASSEMBLY	L150X2M	NAME	REFERENCE DRAWING
DRN	RICHARD LIN	8/01/00	MATERIAL
DSN	RICHARD LIN	8/01/00	FINISH
CKD			QTY
APPD			

SCALE	DIM IN	M.M	STOCK NO.
1-6	±0.1	300-1000	±0.8
6-30	±0.2	1000-2000	±1.2
30-100	±0.3	2000-	±2.0
100-300	±0.5	ANG	±1/2"

DOCUMENT NO.	DRAWING NO.