

**Toggle Switches, AE Series, Process Sealed, Options**

**FUNCTIONS**

The following functions available in SP or DP.

- 01** 2 Positions None indicates no mechanical position
- 03** 3 Positions Off indicates a mechanical position with no electrical connection.
- 05** 3 Positions (On) indicates momentary action.
- 07** 3 Positions
- 08** 2 Positions

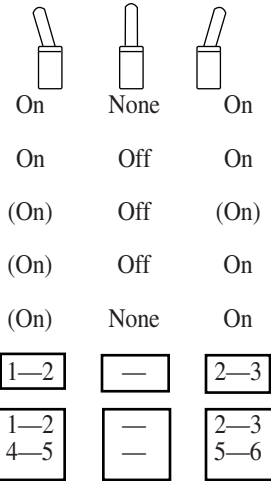

SPDT, connected terminals:

DPDT, connected terminals:

Functions available in DP case only:

- 11** 3 Positions On On On
- 13** 3 Positions (On) On On
- 15** 3 Positions (On) On (On)

DP3T Connect terminals:

\* SP3T Functions achieved with external jumper installed by customer

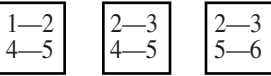

**WIRING DIAGRAM FOR FUNCTIONS**

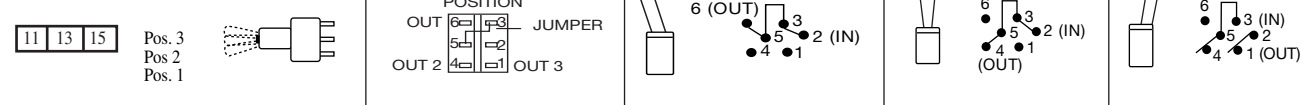

**TOGGLES**

**S**  
Standard

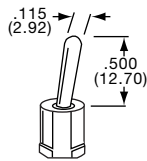

**M**

Short

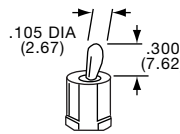

**L**

Lever

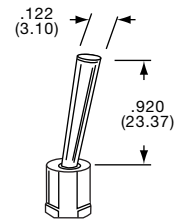

**L1**

Lever

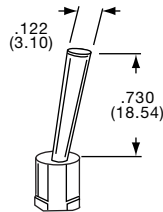

**L2**

Lever

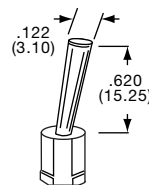

Bushing

**D1**

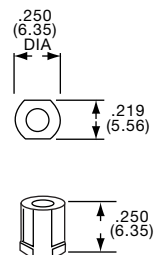

**Toggle Switches, AE Series, Process Sealed, Options**

**TERMINALS**

**Z**  
Wire Lug

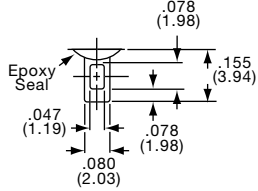

**Z3**  
Quick Connect

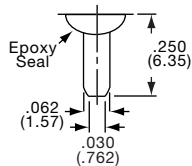

Mates with Tyco  
61454 or 60900.

**W**  
Wire Wrap

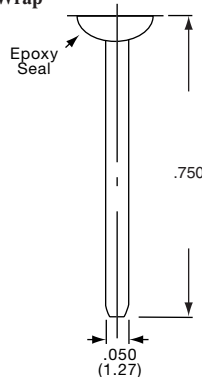

**C**  
Printed Circuit  
PC Hole Pattern

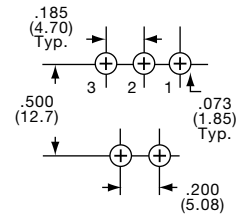
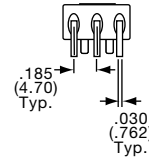
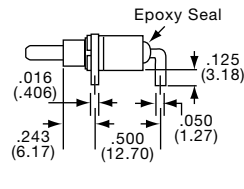
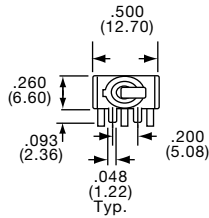
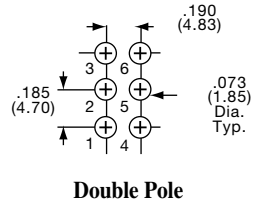
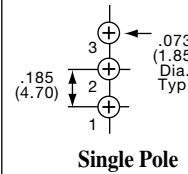
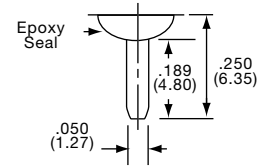

**A**  
Right Angle  
Single Pole

Note: Terminal numbers viewed from top of P.C. board

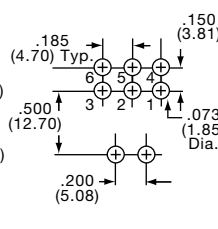
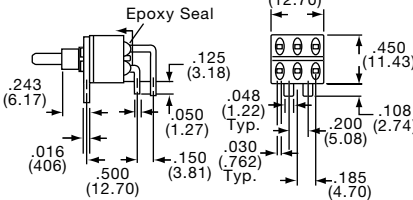
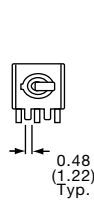

**A**  
Right Angle  
Double Pole

Note: Terminal numbers viewed from top of P.C. board

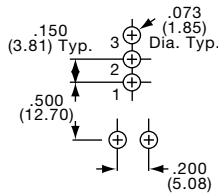
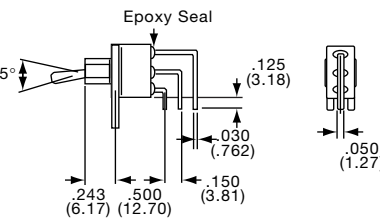
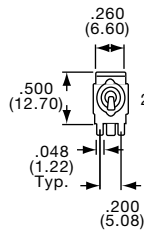

**AV2**  
Vertical Right Angle  
Single Pole

Note: Terminal numbers viewed from top of P.C. board

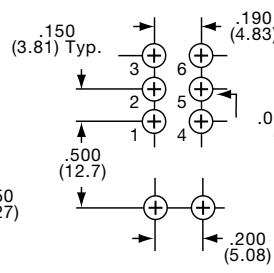
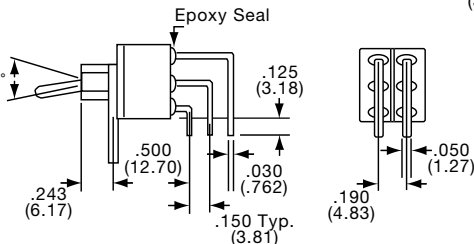
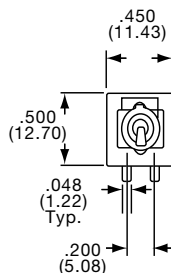

**AV2**  
Vertical Right Angle  
Double Pole

Note: Terminal numbers viewed from top of P.C. board

**Toggle Switches, AE Series, Process Sealed, Options**

**V30**

Vertical Support Bracket  
Single Pole

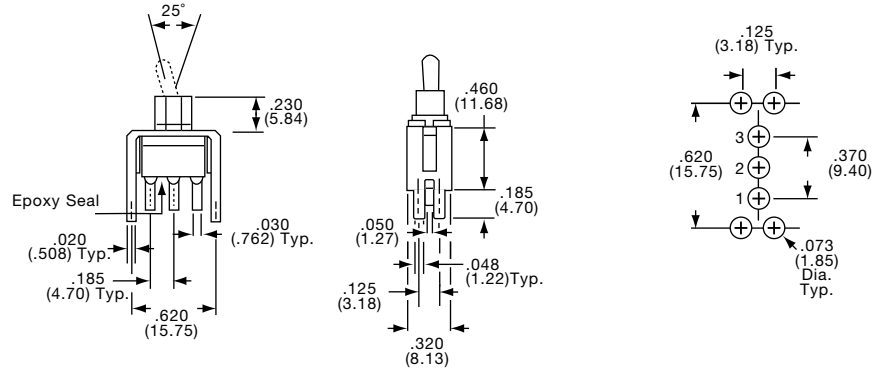

**V30**

Vertical Support Bracket  
Double Pole

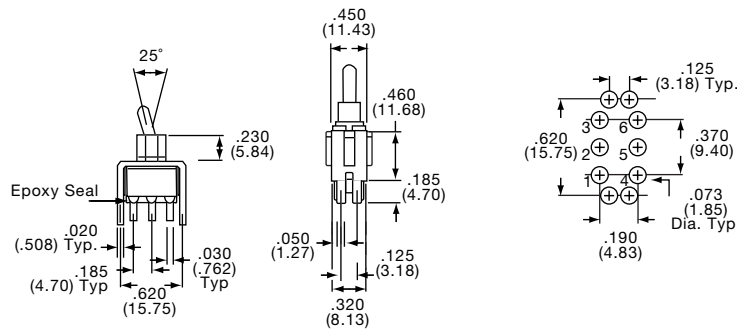

**CONTACTS**

**B** CONTACTS: Copper alloy with gold plate, welded button.

TERMINALS: Copper alloy with gold plate.

ELECTRICAL RATING: 0.4 VA @ 20 VAC/DC.

**Q** CONTACTS: Copper alloy with silver, welded button.

TERMINALS: Copper with silver/lead plate.

ELECTRICAL RATING: 5 A @ 125 VAC, 2 amps @ 250 VAC, 2 A @ 30 VDC.

UL/CSA RATING: 5A @ 125 VAC, 3 @ 250 VAC.  
(Specify "UL" option code)

**G** CONTACTS: Copper alloy with gold plate over silver, welded button.

TERMINALS: Copper alloy, with gold plate.

ELECTRICAL RATING: 0.4 VA @ 20 VAC/DC or 5 A @ 125 VAC, 2 A @ 250 VAC, 2 A @ 30 VDC.

**Note:** This contact option can be used for low-level or power switching. If level is above 0.4 VA @ 20 VAC/DC, the switch is rendered usable only for power switching due to arc-removal of gold plate.

UL/CSA RATING: 5A @ 125 VAC, 3A @ 250 VAC  
(Specify "UL" option code)

**Toggle Switches, AE Series, Process Sealed, Vertical, Long Bat Actuator**

\* Refer to Pages C35-C38 for Additional Options \*

SEE PAGE C35 FOR PRODUCT SPECIFICATIONS

**SPDT**



AE101SD1CQ

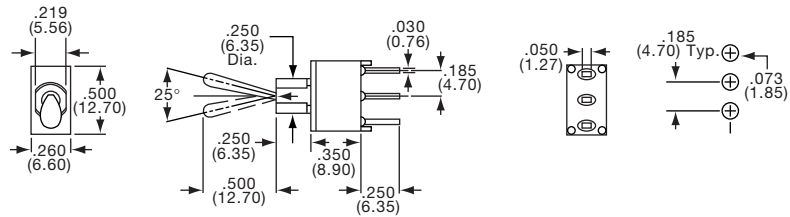

Tyco Electronics	Alcoswitch	Tyco Electronics	Alcoswitch	Type	Act. Code	P. M5			
<b>Silver Contacts</b>		<b>Gold Contacts</b>							
2-1437556-8	AE101SD1CQ	2-1437556-7	AE101SD1CB	SPDT	1		On	None	On
3-1437556-8	AE103SD1CQ	3-1437556-7	AE103SD1CB	SPDT	5		On	Off	On
	AE105SD1CQ	4-1437556-6	AE105SD1CB	SPDT	5		(On)	Off	(On)
	AE107SD1CQ	5-1437556-3	AE107SD1CB	SPDT	5		On	Off	(On)
6-1437556-1	AE108SD1CQ	AE108SD1CB	SPDT	1			On	None	(On)

**DPDT**



AE201SD1CQ

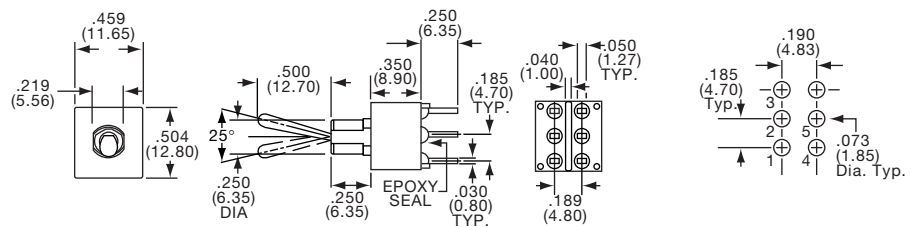

Tyco Electronics	Alcoswitch	Tyco Electronics	Alcoswitch	Type	Act. Code	P. M5			
<b>Silver Contacts</b>		<b>Gold Contacts</b>							
7-1437556-5	AE201SD1CQ	7-1437556-4	AE201SD1CB	DPDT	2		On	None	On
	AE203SD1CQ	8-1437556-2	AE203SD1CB	DPDT	6		On	Off	On
8-1437556-5	AE205SD1CQ	AE205SD1CB	DPDT	6			(On)	Off	(On)
	AE207SD1CQ	AE207SD1CB	DPDT	6			On	Off	(On)
	AE208SD1CQ	AE208SD1CB	DPDT	2			On	None	(On)
	AE211SD1CQ	AE211SD1CB	DPDT	11			On	On	On
	AE215SD1CQ	AE215SD1CB	DPDT	11			(On)	On	(On)

**Toggle Switches, AE Series, Process Sealed, Right Angle, Short Bat Actuator**

\* Refer to Pages C35-C38 for Additional Options \*

SEE PAGE C35 FOR PRODUCT SPECIFICATIONS

SPDT

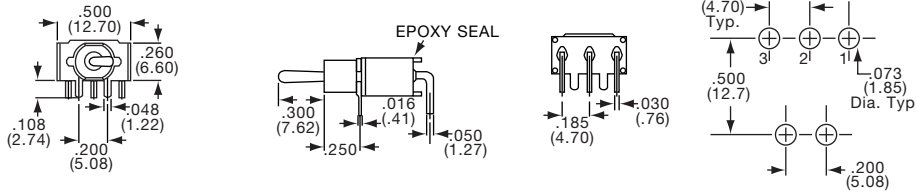

AE101MD1AQ  
Horizontal Actuation

Tyco Electronics	Alcoswitch	Tyco Electronics	Alcoswitch	Type	Act. Code	P. M5			
<b>Silver Contacts</b>		<b>Gold Contacts</b>							
1-1437556-1	AE101MD1AQ	1437556-8	AE101MD1AB	SPDT	1		On	None	On
	AE103MD1AQ	3-1437556-1	AE103MD1AB	SPDT	5		On	Off	On
5-1437556-7	AE108MD1AQ		AE108MD1AB	SPDT	1		On	None	(On)

DPDT

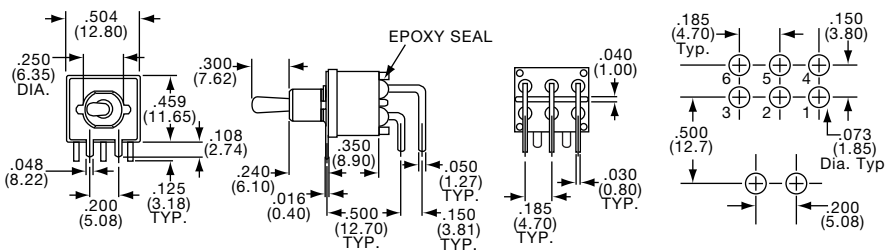

AE201MD1AQ  
Horizontal Actuation

Tyco Electronics	Alcoswitch	Tyco Electronics	Alcoswitch	Type	Act. Code	P. M5			
<b>Silver Contacts</b>		<b>Gold Contacts</b>							
6-1437556-6	AE201MD1AQ	6-1437556-5	AE201MD1AB	DPDT	2		On	None	On
3-1437592-1	AE203MD1AQ	7-1437556-7	AE203MD1AB	DPDT	6		On	Off	On
	AE208MD1AQ		AE208MD1AB	DPDT	2		On	None	(On)

SPDT

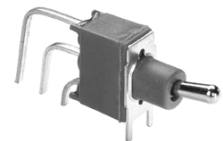
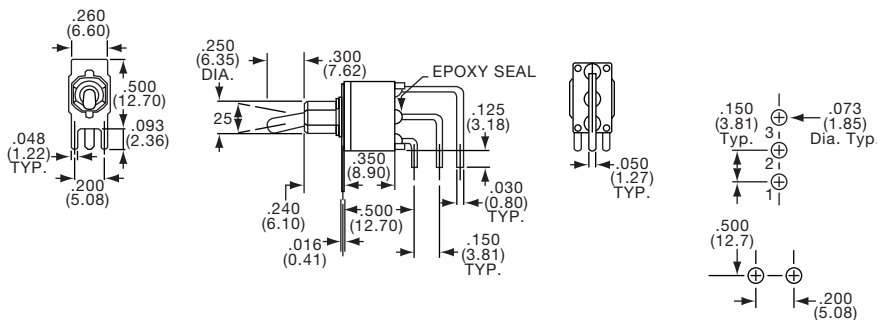

AE101MD1AV2Q  
Vertical Actuation

Tyco Electronics	Alcoswitch	Tyco Electronics	Alcoswitch	Type	Act. Code	P. M5			
<b>Silver Contacts</b>		<b>Gold Contacts</b>							
1-1437556-3	AE101MD1AV2Q	1-1437556-2	AE101MD1AV2B	SPDT	1		On	None	On
	AE103MD1AV2Q	3-1437556-2	AE103MD1AV2B	SPDT	5		On	Off	On
1447331-4	AE108MD1AV2Q	5-1437556-8	AE108MD1AV2B	SPDT	1		On	None	(On)

**Toggle Switches, AE Series, Process Sealed, Short Bat Actuator**

\* Refer to Pages C35-C38 for Additional Options \*

SEE PAGE C35 FOR PRODUCT SPECIFICATIONS

DPDT

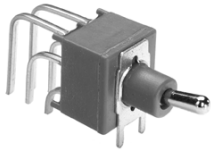

AE201MD1AV2Q

Vertical Actuation

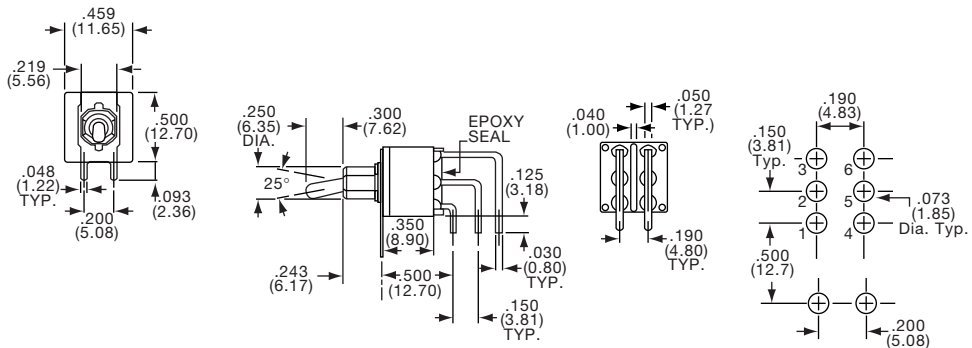

Tyco Electronics	Alcoswitch	Tyco Electronics	Alcoswitch	Type	Act. Code	P. M5	On	None	On
<b>Silver Contacts</b>		<b>Gold Contacts</b>							
1571537-1	AE201MD1AV2Q	6-1437556-7	AE201MD1AV2B	DPDT	2		On	None	On
	AE203MD1AV2Q	7-1437556-8	AE203MD1AV2B	DPDT	6		On	Off	On
	AE208MD1AV2Q		AE208MD1AV2B	DPDT	2		On	None	(On)

SPDT



AE101MD1CQ

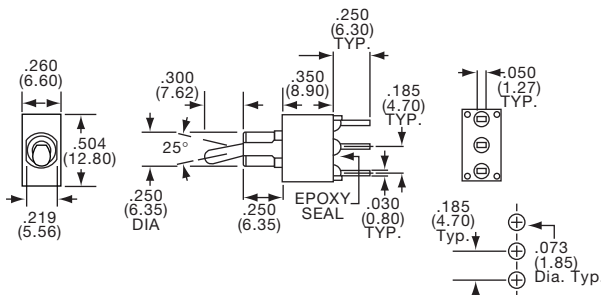

Tyco Electronics	Alcoswitch	Type	Act. Code	P.M5	On	None	On
<b>Silver Contacts</b>							
1-1437556-7	AE101MD1CQ	SPDT	1		On	None	On
	AE103MD1CQ	SPDT	5		On	Off	On
	AE105MD1CQ	SPDT	5		(On)	Off	(On)
	AE107MD1CQ	SPDT	5		On	Off	(On)
	AE108MD1CQ	SPDT	1		On	None	(On)
<b>Gold Contacts</b>							
1-1437556-5	AE101MD1CB	SPDT	1		On	None	On
3-1437556-3	AE103MD1CB	SPDT	5		On	Off	On
	AE105MD1CB	SPDT	5		(On)	Off	(On)
	AE107MD1CB	SPDT	5		On	Off	(On)
	AE108MD1CB	SPDT	1		On	None	(On)

DPDT



AE201MD1CQ

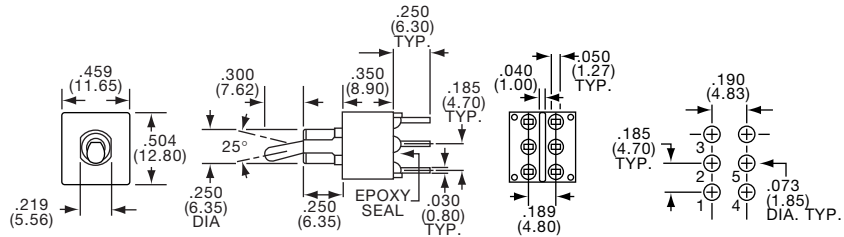

Tyco Electronics	Alcoswitch	Type	Act. Code	P.M5	On	None	On
<b>Silver Contacts</b>							
6-1437556-9	AE201MD1CQ	DPDT	2		On	None	On
	AE203MD1CQ	DPDT	6		On	Off	On
	AE205MD1CQ	DPDT	6		(On)	Off	(On)
	AE207MD1CQ	DPDT	6		On	Off	(On)
	AE208MD1CQ	DPDT	2		On	None	(On)
	AE211MD1CQ	SP3T	11		On	On	On
	AE215MD1CQ	SP3T	11		(On)	On	(On)
<b>Gold Contacts</b>							
6-1437556-8	AE201MD1CB	DPDT	2		On	None	On
	AE203MD1CB	DPDT	6		On	Off	On
	AE205MD1CB	DPDT	6		(On)	Off	(On)
	AE207MD1CB	DPDT	6		On	Off	(On)
	AE208MD1CB	DPDT	2		On	None	(On)
8-1437556-9	AE211MD1CB	SP3T	11		On	On	On
	AE215MD1CB	SP3T	11		(On)	On	(On)

**Toggle Switches, AE Series, Process Sealed, Right Angle, Long Bat Actuator**

\* Refer to Pages C35-C38 for Additional Options \*

SEE PAGE C35 FOR PRODUCT SPECIFICATIONS

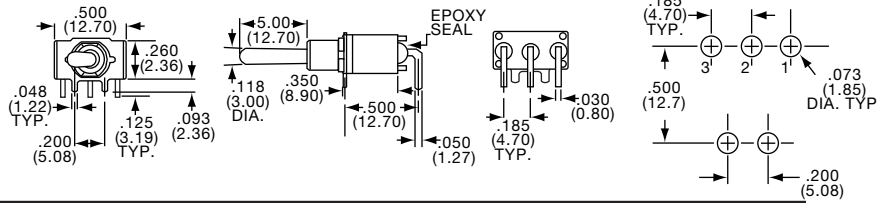

SPDT



AE101SD1AQ  
Horizontal Actuation

Tyco Electronics	Alcoswitch	Tyco Electronics	Alcoswitch	Type	Act. Code	P. M5			
<b>Silver Contacts</b>		<b>Gold Contacts</b>							
6-1437556-0	AE101SD1AQ	2-1437556-2	AE101SD1AB	SPDT	1		On	None	On
	AE103SD1AQ		AE103SD1AB	SPDT	5		On	Off	On
2-1437556-3	AE108SD1AQ	5-1437556-9	AE108SD1AB	SPDT	5		(On)	Off	(On)

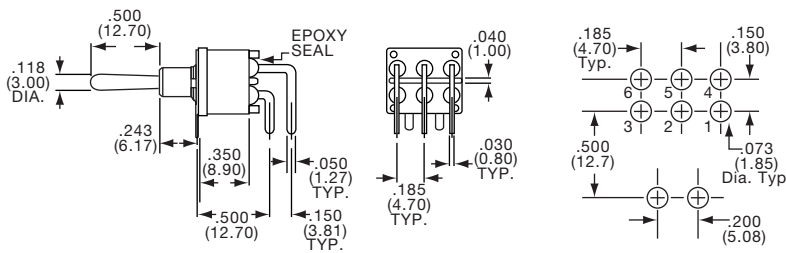

DPDT

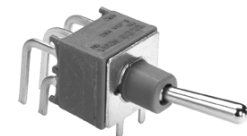

AE201SD1AB  
Horizontal Actuation

Tyco Electronics	Alcoswitch	Tyco Electronics	Alcoswitch	Type	Act. Code	P. M5			
<b>Silver Contacts</b>		<b>Gold Contacts</b>							
	AE201SD1AQ	7-1437556-1	AE201SD1AB	DPDT	2		On	None	On
	AE203SD1AQ		AE203SD1AB	DPDT	6		On	Off	On
	AE208SD1AQ	7-1437556-9	AE208SD1AB	DPDT	6		(On)	Off	(On)

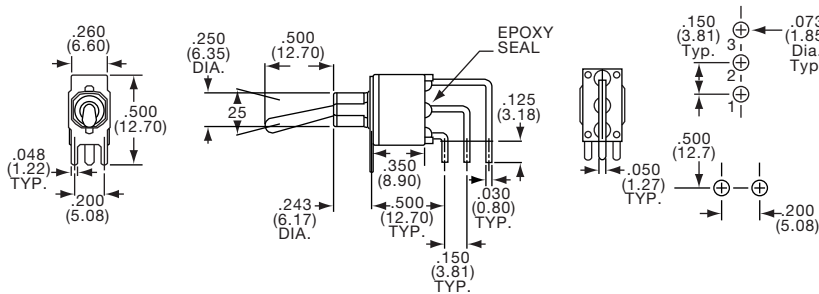

SPDT



AE101SD1AV2B  
Vertical Actuation

Tyco Electronics	Alcoswitch	Tyco Electronics	Alcoswitch	Type	Act. Code	P. M5			
<b>Silver Contacts</b>		<b>Gold Contacts</b>							
2-1437556-6	AE101SD1AV2Q	2-1437556-5	AE101SD1AV2B	SPDT	1		On	None	On
	AE103SD1AV2Q	3-1437556-6	AE103SD1AV2B	SPDT	5		On	Off	On
	AE108SD1AV2Q		AE108SD1AV2B	SPDT	5		(On)	Off	(On)

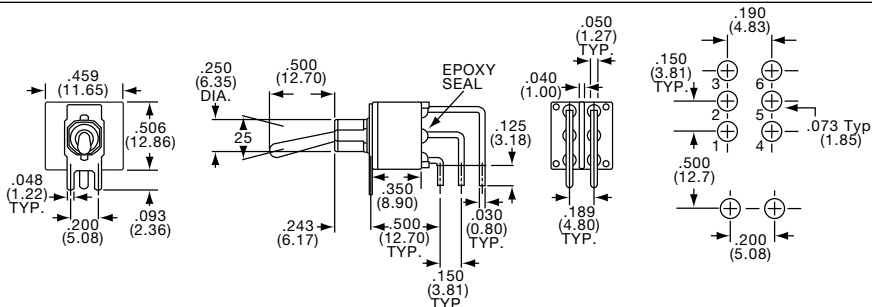

DPDT

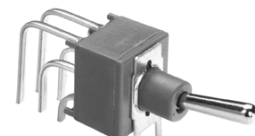

AE201SD1AV2Q  
Vertical Actuation

Tyco Electronics	Alcoswitch	Tyco Electronics	Alcoswitch	Type	Act. Code	P. M5			
<b>Silver Contacts</b>		<b>Gold Contacts</b>							
8-1437556-1	AE201SD1AV2Q	7-1437556-3	AE201SD1AV2B	DPDT	2		On	None	On
	AE203SD1AV2Q	8-1437556-0	AE203SD1AV2B	DPDT	6		On	Off	On
	AE208SD1AV2Q		AE208SD1AV2B	DPDT	6		(On)	Off	(On)

**Toggle Switches, MT Series, Wire Lug, Long Bat Actuator**

**MATERIAL SPECIFICATIONS:**

Contacts .....Gold flash over silver  
 Actuator Material .....Chrome plated copper alloy  
 Case Material .....Thermoset 94V-0  
 Terminals .....Gold flash  
 Terminal Seal .....Epoxy

**ENVIRONMENTAL SPECIFICATIONS**

Operating Temperature .....4°F to +176°F (-20°C to +80°C)  
 Storage Temperature .....-40°F to +176°F (-40°C to +80°C)  
 Solder Heat Resistance.....See page M3-4

UL Available when ordering . . . Consult factory.

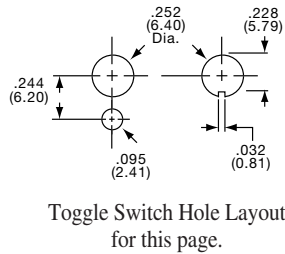
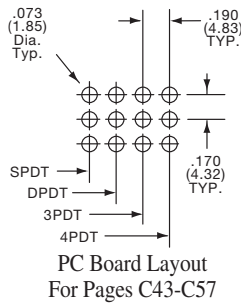

**TYPICAL PERFORMANCE CHARACTERISTICS:**

Contact Rating .....6 A @ 125 VAC, 3 A @ 250 VAC,  
 4A @ 28 VDC  
 Initial Contact Resistance.....20 Milliohms max.  
 Contact Timing.....Break before make  
 Insulation Resistance .....1,000 Megohms min. @ 500 VDC  
 min. for 1 minute  
 Dielectric Strength .....1,500 VAC  
 Actuation Force ......05-1.5 kg.  
 Actuator Travel .....24° (26° on MTL Series)  
 High Torque Bushing Shoulder .....Standard  
 Life Expectancy .....See chart below.

**NOTICE: For terminal connections refer to Code Chart Page M5-6.**

Note: Hardware included with all switches

Green Series toggle life expectancy chart			
Parameter	2 Pos.	3 Pos.	Momentary
Mechanical (no load)	150,000	100,000	60,000
250AC (3A Resistive)	80,000	60,000	60,000
125AC (6A Resistive)	80,000	60,000	60,000
28DC(4) (Resistive)	60,000	50,000	40,000

**SPDT/DPDT/SP3T**

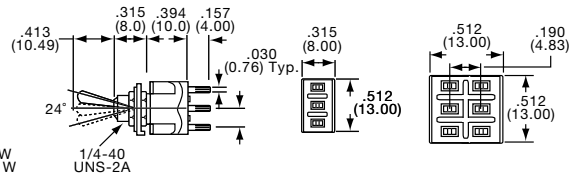
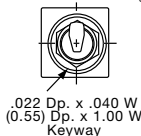
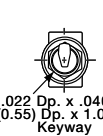
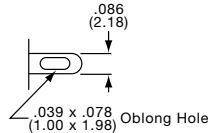

Tyco Electronics	Alcoswitch	Type	Act. Code	P. M5	↖	↓	↗	Tyco Electronics	Alcoswitch	Type	Act. Code	P. M5	↖	↓	↗
1-1437558-0	MTA106D	SPDT	1	On	None	On		2-1437558-0	MTA206N	DPDT	2	On	None	On	
1-1437558-2	MTA106E	SPDT	5	On	Off	On		2-1437558-2	MTA206P	DPDT	6	On	Off	On	
1-1437558-4	MTA106F	SPDT	1	On	None	(On)		2-1437558-7	MTA206R	DPDT	2	On	None	(On)	
1-1437558-6	MTA106G	SPDT	5	(On)	Off	(On)		2-1437558-9	MTA206S	DPDT	6	(On)	Off	(On)	
1-1437558-8	MTA106H	SPDT	5	On	Off	(On)		3-1437558-2	MTA206T	DPDT	6	On	Off	On	
								2-1437558-3	*MTA206PA	SP3T	11	On	On	On	
								3-1437558-0	*MTA206SA	SP3T	11	(On)	(On)	(On)	
								3-1437558-3	*MTA206TA	SP3T	11	On	On	(On)	

(On) indicates momentary position.

\* Note: PA, SA & TA types have case .100(2.50) longer than other types.

**3PDT/4PDT/DP3T**

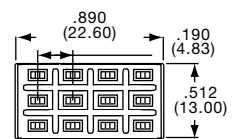
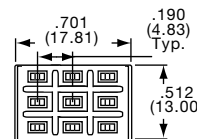
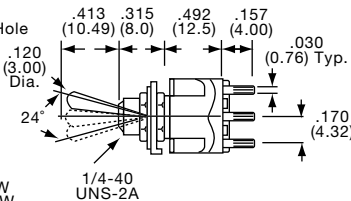
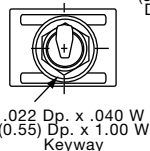
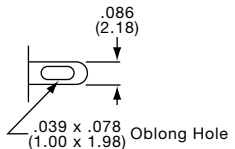

Tyco Electronics	Alcoswitch	Type	Act. Code	P. M5	↖	↓	↗	Tyco Electronics	Alcoswitch	Type	Act. Code	P. M5	↖	↓	↗
3-1437558-5	MTA306D	3PDT	3	On	None	On		4-1437558-3	MTA406N	4PDT	4	On	None	On	
3-1437558-7	MTA306E	3PDT	7	On	Off	On		4-1437558-5	MTA406P	4PDT	8	On	Off	On	
3-1437558-9	MTA306F	3PDT	3	On	None	(On)		4-1437558-6	*MTA406PA	DP3T	12	On	On	On	
4-1437558-1	MTA306H	3PDT	7	On	Off	(On)									

(On) indicates momentary position.

\*Note: PA types have case .100(2.50) longer than other types.



**Toggle Switches, MT Series, PC Tail, Long Bat Actuator**

SEE PAGE C43 FOR PRODUCT SPECIFICATIONS

For terminal connections refer to Code Chart. (See Page M5-6)

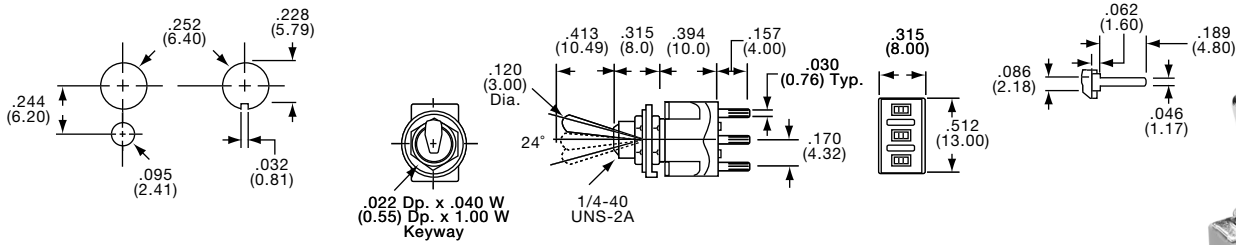

SPDT



MTA106DPC

Tyco Electronics	Alcoswitch	Type	Act. Code	P. M5	On	None	On
1-1437558-1	MTA106DPC	SPDT	1		On	None	On
1-1437558-3	MTA106EPC	SPDT	5		On	Off	On
1-1437558-5	MTA106FPC	SPDT	1		On	None	(On)

Tyco Electronics	Alcoswitch	Type	Act. Code	P. M5	On	None	On
1-1437558-7	MTA106GPC	SPDT	5		(On)	Off	(On)
1-1437558-9	MTA106HPC	SPDT	5		On	Off	(On)

(On) indicates momentary position.

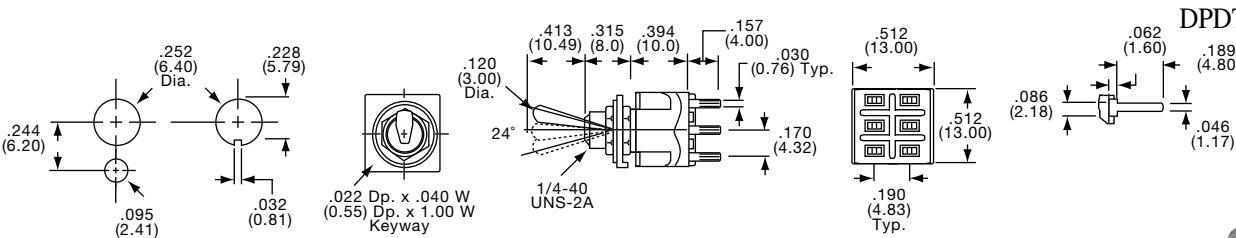

DPDT/SP3T



MTA206NPC

Tyco Electronics	Alcoswitch	Type	Act. Code	P. M5	On	None	On
2-1437558-1	MTA206NPC	DPDT	2		On	None	On
2-1437558-5	MTA206PPC	DPDT	6		On	Off	On
2-1437558-8	MTA206RPC	DPDT	2		On	None	(On)
3-1437558-1	MTA206SPC	DPDT	6		(On)	Off	(On)
3-1437558-4	MTA206TPC	DPDT	6		On	Off	(On)

Tyco Electronics	Alcoswitch	Type	Act. Code	P. M5	On	None	On
2-1437558-4	*MTA206PAPC	SP3T	11		On	On	On
	MTA206SAPC	SP3T	11		(On)	On	(On)

(On) indicates momentary position.  
\* Note: PA types - case .100(2.50) longer than other types.

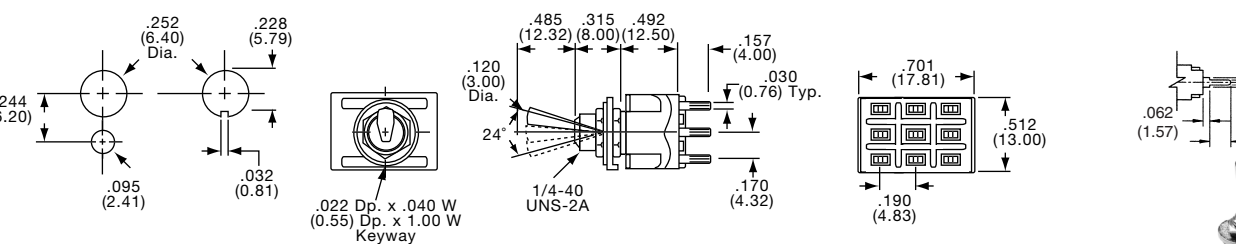

3PDT



MTA306DPC

Tyco Electronics	Alcoswitch	Type	Act. Code	P. M5	On	None	On
3-1437558-6	MTA306DPC	3PDT	3		On	None	On
3-1437558-8	MTA306EPC	3PDT	7		On	Off	On

Tyco Electronics	Alcoswitch	Type	Act. Code	P. M5	On	None	On
4-1437558-0	MTA306FPC	3PDT	3		On	None	(On)
4-1437558-2	MTA306HPC	3PDT	7		On	Off	(On)

(On) indicates momentary position.

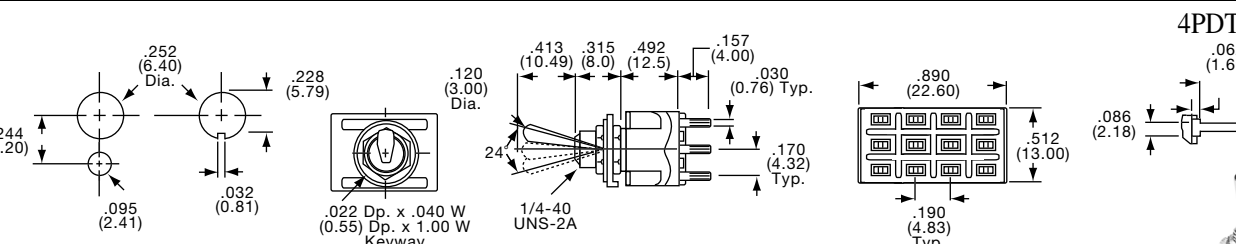

4PDT/DP3T



MTA406NPC

Tyco Electronics	Alcoswitch	Type	Act. Code	P. M5	On	None	On
4-1437558-4	MTA406NPC	4PDT	4		On	None	On
4-1437558-8	MTA406PPC	4PDT	8		On	Off	On

  

Tyco Electronics	Alcoswitch	Type	Act. Code	P. M5	On	None	On
4-1437558-7	MTA406PAPC	DP3T	12		On	On	On

**Toggle Switches, MT Series, Wire Lug, Decorative Bat Actuator**

SEE PAGE C43 FOR PRODUCT SPECIFICATIONS

For terminal connections refer to Code Chart. (See Page M5-6)

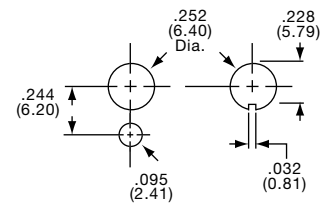
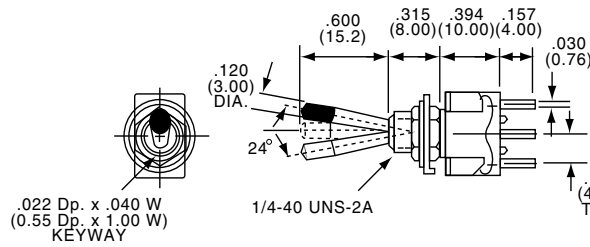

MTB106D

Tyco Electronics	Alcoswitch	Type	Act. Code	P. M5	On	None	On	Alcoswitch	Type	Act. Code	P. M5	On	None	On
6-1437558-3	MTB106D	SPDT	1		On	None	On	MTB106F	SPDT	1		On	None	(On)
6-1437558-2	MTB106E	SPDT	5		On	Off	On	MTB106G	SPDT	5		(On)	Off	(On)

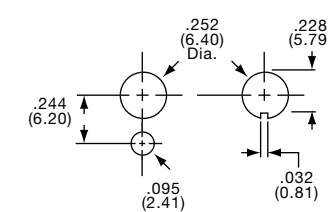
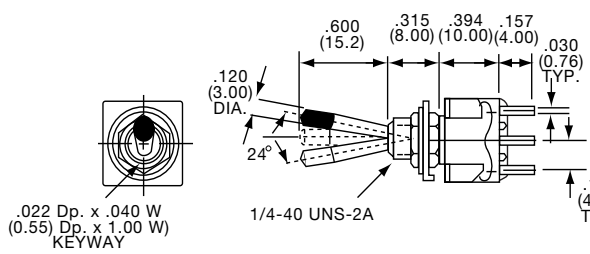
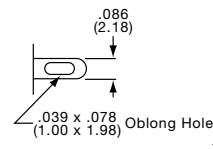

MTB206N

Tyco Electronics	Alcoswitch	Type	Act. Code	P. M5	On	None	On	Alcoswitch	Type	Act. Code	P. M5	On	None	On
6-1437558-4	MTB206N	DPDT	2		On	None	On	MTB206T	DPDT	6		On	Off	(On)
6-1437558-5	MTB206P	DPDT	6		On	Off	On							

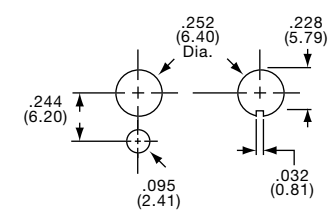
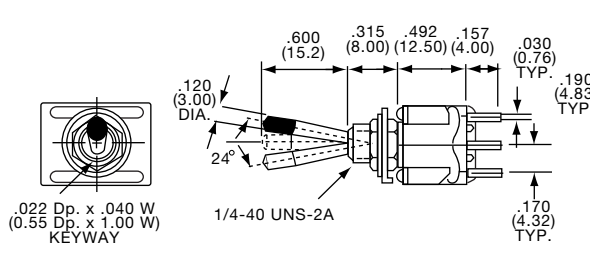
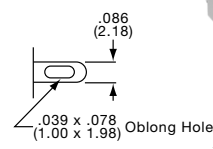

MTB306D

Tyco Electronics	Alcoswitch	Type	Act. Code	P. M5	On	None	On
6-1437558-6	MTB306D	3PDT	3		On	None	On

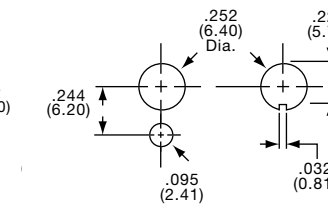
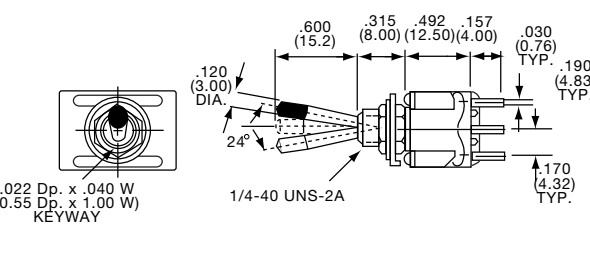
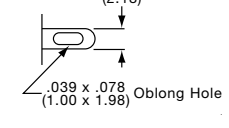

MTB406N

Tyco Electronics	Alcoswitch	Type	Act. Code	P. M5	On	None	On
6-1437558-7	MTB406N	4PDT	4		On	None	On

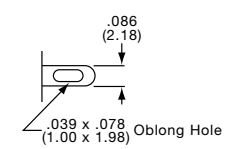

C  
MTB Series

**Toggle Switches, MT Series, Wire Lug, Splashproof Bat Actuator**

For terminal connections refer to Code Chart. (See Page M5-6)

SEE PAGE C43 FOR PRODUCT SPECIFICATIONS

SPDT



MTE106E

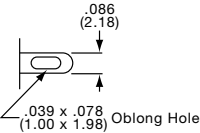
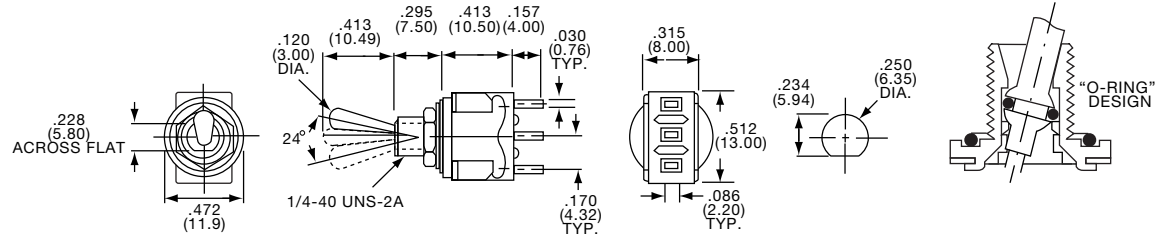

Tyco Electronics	Alcoswitch	Type	Act.	Code	P.	M5			
6-1437558-8	MTE106D	SPDT	1	On	None	On			
6-1437558-9	MTE106E	SPDT	5	On	Off	On			
7-1437558-0	MTE106F	SPDT	1	On	None	(On)			
7-1437558-1	MTE106G	SPDT	5	(On)	Off	(On)			
	MTE106H	SPDT	5	On	Off	(On)			

(On) indicates momentary position.

DPDT/SP3T



MTE206N

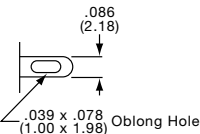
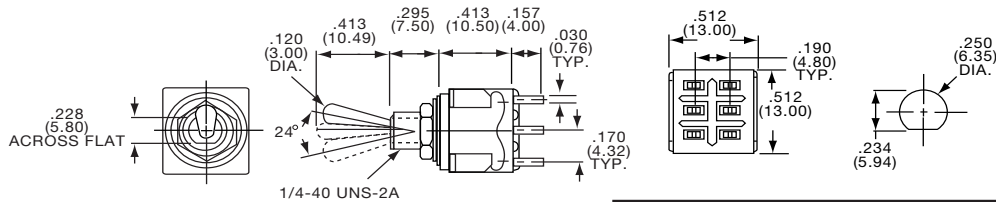

Tyco Electronics	Alcoswitch	Type	Act.	Code	P.	M5			
7-1437558-2	MTE206N	DPDT	2	On	None	On			
7-1437558-3	MTE206P	DPDT	6	On	Off	On			
7-1437558-5	MTE206R	DPDT	2	On	None	(On)			
7-1437558-6	MTE206S	DPDT	6	(On)	Off	(On)			
7-1437558-7	MTE206T	DPDT	6	On	Off	(On)			
7-1437558-4	*MTE206PA	SP3T	11	On	On	On			

(On) indicates momentary position.  
\*Note: PA types have case .100/(2.50) longer than other types.

3PDT



MTE306D

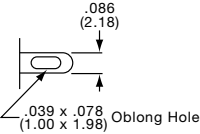
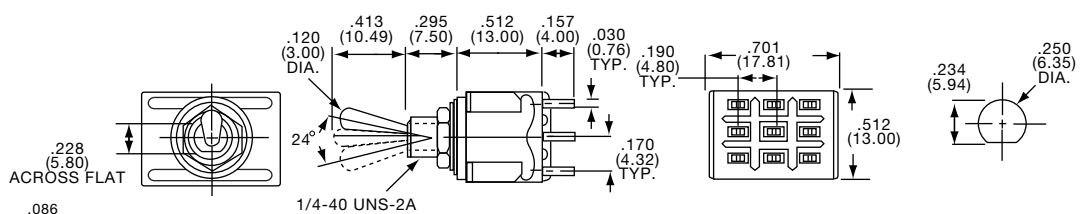

Tyco Electronics	Alcoswitch	Type	Act.	Code	P.	M5			
7-1437558-8	MTE306D	3PDT	3	On	None	On			
7-1437558-9	MTE306E	3PDT	7	On	Off	On			

4PDT



MTE406N

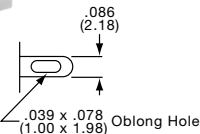
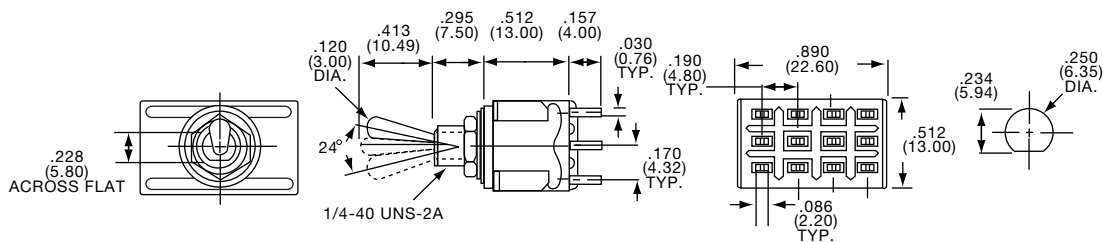

Tyco Electronics	Alcoswitch	Type	Act.	Code	P.	M5			
8-1437558-0	MTE406N	4PDT	4	On	None	On			
8-1437558-1	MTE406P	4PDT	8	On	Off	On			

**Toggle Switches, MT Series, Wire Lug, Flat Actuator**

SEE PAGE C43 FOR PRODUCT SPECIFICATIONS

For terminal connections refer to Code Chart. (See Page M5-6)

SPDT

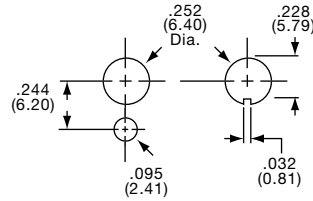
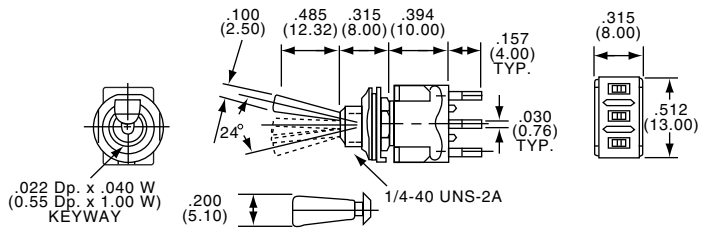

MTF106D

Satin Chrome		Bright Chrome		Type	Act. Code	P. M5	
Tyco Electronics	Alcoswitch	Tyco Electronics	Alcoswitch				
8-1437558-3	MTF106D	8-1437558-8	MTF126D	SPDT	1	On None On	
8-1437558-4	MTF106E	8-1437558-9	MTF126E	SPDT	5	On Off On	
8-1437558-5	MTF106F	9-1437558-0	MTF126F	SPDT	1	On None(On)	
8-1437558-6	MTF106G	9-1437558-1	MTF126G	SPDT	5	(On) Off (On)	
8-1437558-7	MTF106H			SPDT	5	On Off (On)	

(On) indicates momentary position.

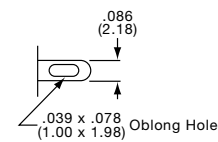

C  
MTF Series

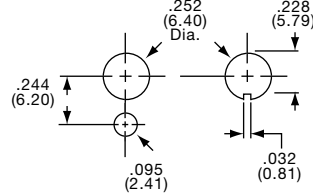
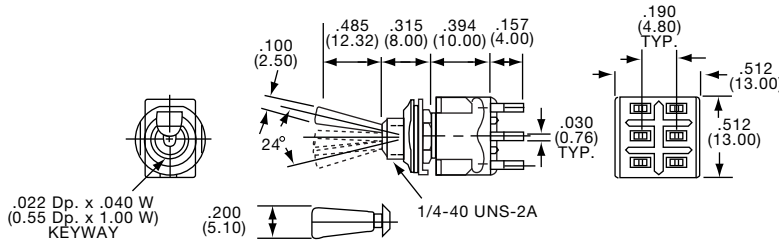

DPDT/SP3T



MTF206N

Satin Chrome		Bright Chrome		Type	Act. Code	P. M5	
Tyco Electronics	Alcoswitch	Tyco Electronics	Alcoswitch				
9-1437558-2	MTF206N	9-1437558-9	MTF226N	DPDT	2	On None On	
9-1437558-3	MTF206P	1437559-1	MTF226P	DPDT	6	On Off On	
9-1437558-5	MTF206R			DPDT	2	On None(On)	
9-1437558-6	MTF206S	1437559-4	MTF226S	DPDT	6	(On) Off (On)	
9-1437558-8	MTF206T			DPDT	6	On Off (On)	
9-1437558-4	*MTF206PA	1437559-2	*MTF226PA	SP3T	11	On On On	
9-1437558-7	*MTF206SA	1437559-5	*MTF226SA	SP3T	11	(On) On (On)	

\*Note: PA & SA types have case .100/(2.50) longer than other types.

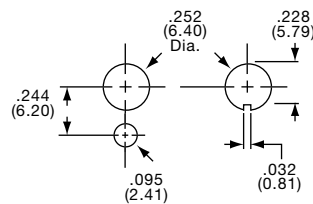
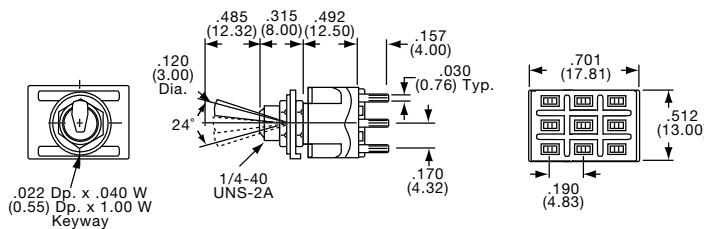
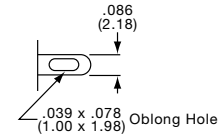

3PDT



MTF306D

Satin Chrome		Bright Chrome		Type	Act. Code	P. M5	
Tyco Electronics	Alcoswitch	Tyco Electronics	Alcoswitch				
1437559-6	MTF306D	1437559-7	MTF326D	3PDT	3	On None On	

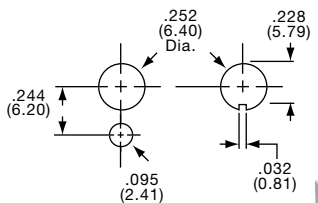
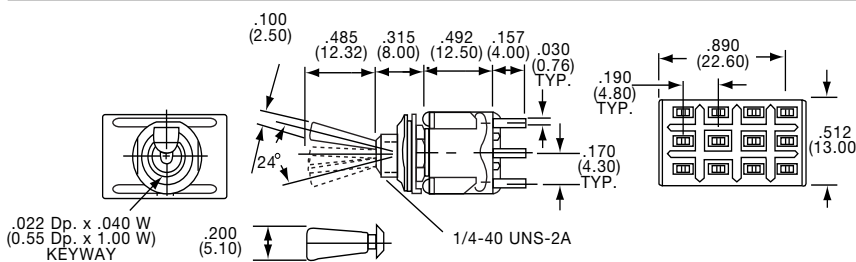
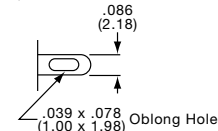

4PDT



MTF406N

Satin Chrome		Bright Chrome		Type	Act. Code	P. M5	
Tyco Electronics	Alcoswitch	Tyco Electronics	Alcoswitch				
1437559-8	MTF406N	1437559-9	MTF426N	4PDT	4	On None On	

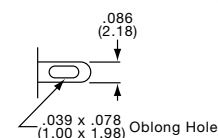

**Toggle Switches, MT Series, Wire Lug, Short Mustang Actuator**

For terminal connections refer to Code Chart. (See Page M5-6)

SEE PAGE C43 FOR PRODUCT SPECIFICATIONS

**SPDT**



MTG106D

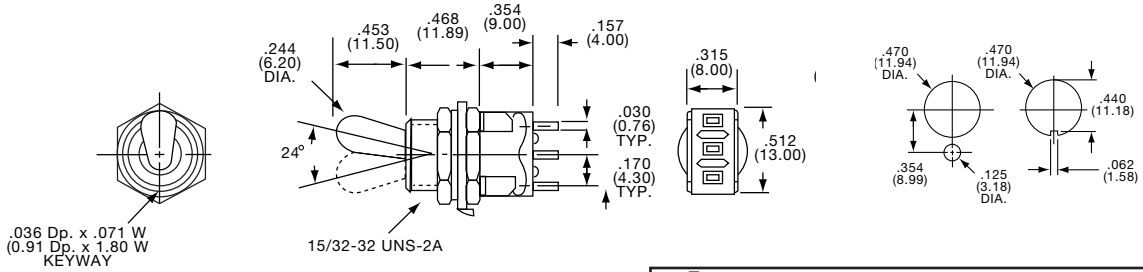

.036 Dp. x .071 W  
(0.91 Dp. x 1.80 W  
KEYWAY)

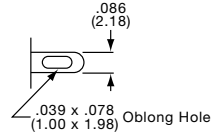

Tyco Electronics	Alcoswitch	Type	Act.	Code	P. M5	↖	↕	↗
1-1437559-1	MTG106D	SPDT	1	On	None	On		
1-1437559-2	MTG106E	SPDT	5	On	Off	On		
1-1437559-3	MTG106F	SPDT	1	On	None	(On)		
1-1437559-4	MTG106G	SPDT	5	(On)	Off	(On)		
1-1437559-5	MTG106H	SPDT	5	On	Off	(On)		

(On) indicates momentary position.

**DPDT/SP3T**



MTG206N

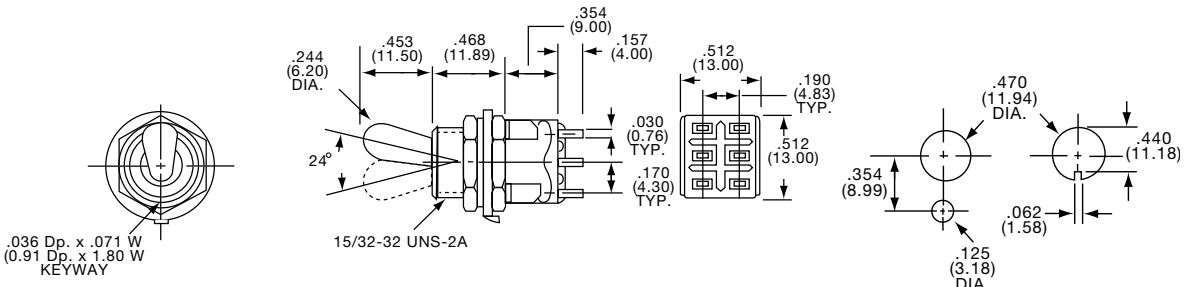

.036 Dp. x .071 W  
(0.91 Dp. x 1.80 W  
KEYWAY)

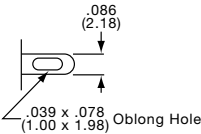

Tyco Electronics	Alcoswitch	Type	Act.	Code	P. M5	↖	↕	↗
1-1437559-8	MTG206N	DPDT	2	On	None	On		
2-1437559-0	MTG206P	DPDT	6	On	Off	On		
2-1437559-2	MTG206R	DPDT	2	On	None	(On)		
2-1437559-3	MTG206S	DPDT	2	(On)	Off	(On)		
2-1437559-4	*MTG206T	DPDT	6	On	Off	(On)		
2-1437559-1	*MTG206PA	SP3T	11	On	On	On		

(On) indicates momentary position.  
\*Note: PA types have case .100/(2.50) longer than other types.

**3PDT**



MTG306D

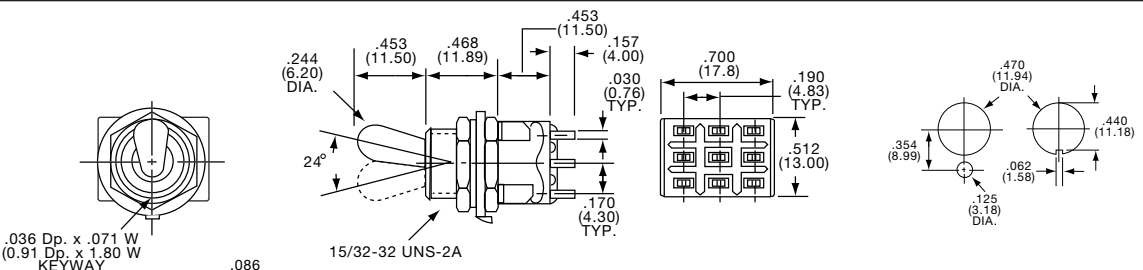

.036 Dp. x .071 W  
(0.91 Dp. x 1.80 W  
KEYWAY)

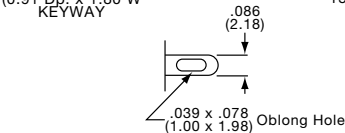

Tyco Electronics	Alcoswitch	Type	Act.	Code	P. M5	↖	↕	↗
2-1437559-8	MTG306D	3PDT	3	On	None	On		
2-1437559-9	MTG306E	3PDT	7	On	Off	On		

**4PDT**



MTG406N

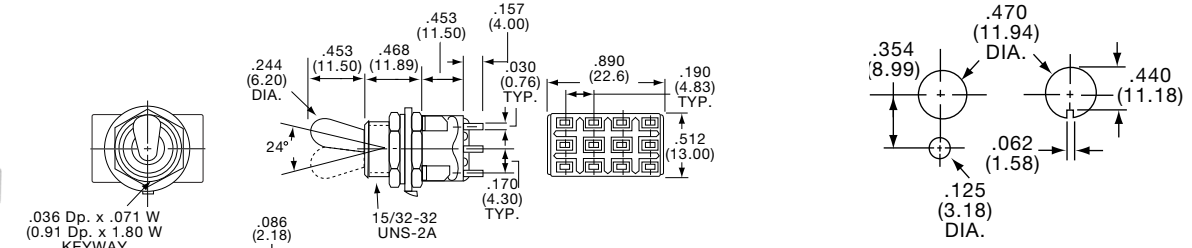

.036 Dp. x .071 W  
(0.91 Dp. x 1.80 W  
KEYWAY)

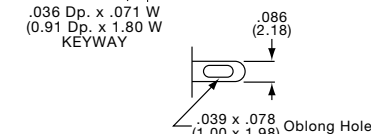

Tyco Electronics	Alcoswitch	Type	Act.	Code	P. M5	↖	↕	↗
3-1437559-1	MTG406N	4PDT	4	On	None	On		
3-1437559-2	MTG406P	4PDT	8	On	Off	On		

**Toggle Switches, MT Series, Wire Lug, Long Mustang Actuator**

SEE PAGE C43 FOR PRODUCT SPECIFICATIONS

For terminal connections refer to Code Chart. (See Page M5-6)

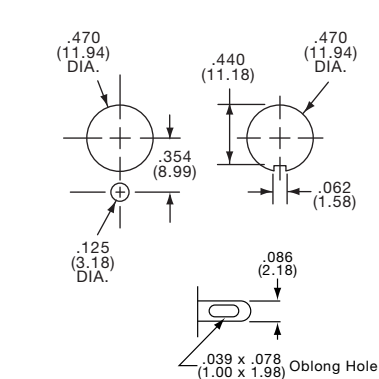
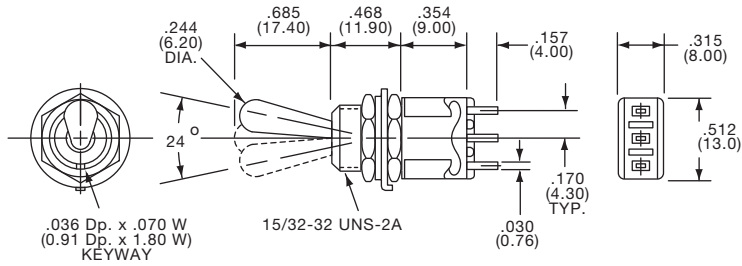

Tyco Electronics	Alcoswitch	Type	Act. Code P. M5	On	None	On
1-1437559-6	MTG126D	SPDT	1	On	None	On
1-1437559-7	MTG126E	SPDT	5	On	Off	On

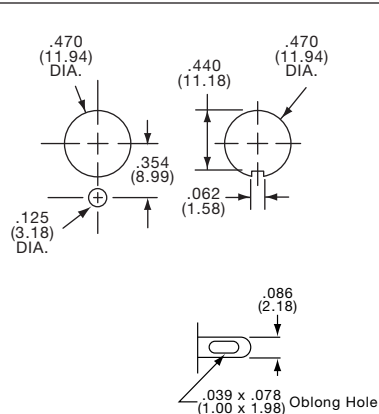
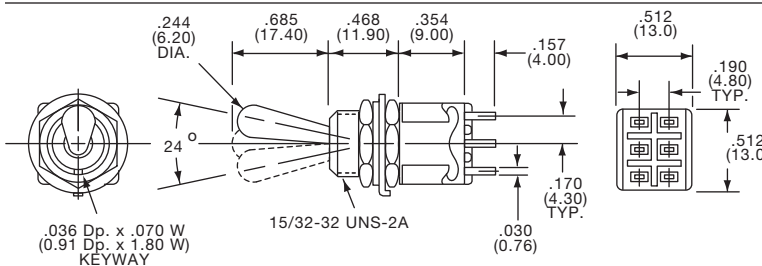

Tyco Electronics	Alcoswitch	Type	Act. Code P. M5	On	None	On
2-1437559-5	MTG226N	DPDT	2	On	None	On
2-1437559-6	MTG226P	DPDT	6	On	Off	On
2-1437559-7	*MTG226PA	SP3T	11	On	On	On

\*Note: PA types have case .100/(2.50) longer than other types.

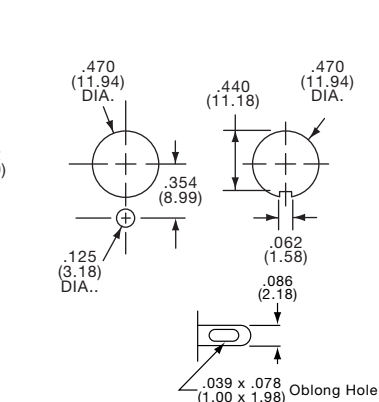
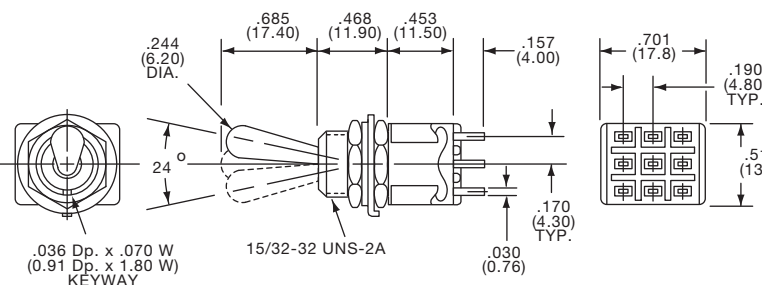

Tyco Electronics	Alcoswitch	Type	Act. Code P. M5	On	None	On
3-1437559-0	MTG326D	3PDT	3	On	None	On

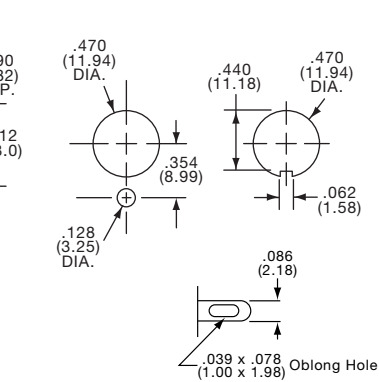
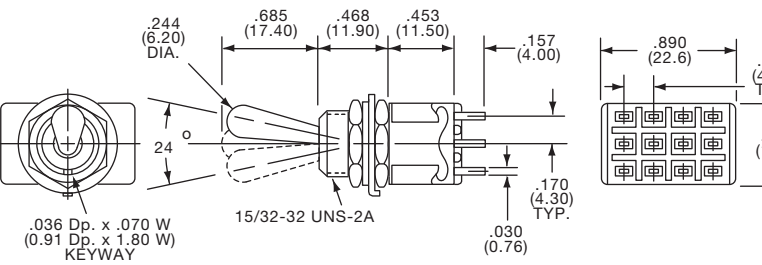

Tyco Electronics	Alcoswitch	Type	Act. Code P. M5	On	None	On
3-1437559-3	MTG426N	4PDT	4	On	None	On

**Toggle Switches, MT Series, Wire Lug, Miniature Locking**

For terminal connections refer to Code Chart. (See Page M5-6)

SEE PAGE C43 FOR PRODUCT SPECIFICATIONS

**SPDT**

**MTL106D**

.022 Dp. x .040 W  
(0.55 Dp. x 1.00 W)  
KEYWAY

.086 (2.18)

.039 x .078 (1.00 x 1.98) Oblong Hole

.650 (17.0) UNLOCKED  
.590 (15.0) LOCKED

.217 (5.51) DIA.

26°

.315 (8.00)

.433 (11.00)

1/4-40 UNS-2A

.157 (4.00)

.170 (4.32) TYP.

.030 (0.76) TYP.

.315 (8.00)

.512 (13.00)

.252 (6.40) Dia.

.228 (5.79)

.244 (6.20)

.095 (2.41)

.032 (0.81)

Tyco Electronics	Alcoswitch	Type	Act. Code P. M5	On	None	On
3-1437559-4	MTL106D	SPDT	1	On	None	On
3-1437559-5	MTL106E	SPDT	5	On	Off	On

**DPDT/SP3T**

**MTL206N**

.022 Dp. x .040 W  
(0.55 Dp. x 1.00 W)  
KEYWAY

.086 (2.18)

.039 x .078 (1.00 x 1.98) Oblong Hole

.650 (17.0) UNLOCKED  
.590 (15.0) LOCKED

.217 (5.51) DIA.

26°

.315 (8.00)

.433 (11.00)

1/4-40 UNS-2A

.157 (4.00)

.170 (4.32) TYP.

.030 (0.76) TYP.

.512 (13.00)

.190 (4.83) TYP.

.252 (6.40) Dia.

.228 (5.79)

.244 (6.20)

.095 (2.41)

.032 (0.81)

Tyco Electronics	Alcoswitch	Type	Act. Code P. M5	On	None	On
3-1437559-7	MTL206N	DPDT	2	On	None	On
3-1437559-9	MTL206P	DPDT	6	On	Off	On
4-1437559-1	MTL206S	DPDT	6	(On)	Off	(On)
4-1437559-0	*MTL206PA	SP3T	11	On	On	On

(On) indicates momentary position.  
\*Note: PA types have case .100/(2.50) longer than other types.

**3PDT**

**MTL306D**

.022 Dp. x .040 W  
(0.55 Dp. x 1.00 W)  
KEYWAY

.086 (2.18)

.039 x .078 (1.00 x 1.98) Oblong Hole

.650 (17.0) UNLOCKED  
.590 (15.0) LOCKED

.217 (5.51) DIA.

26°

.315 (8.00)

.532 (13.50)

1/4-40 UNS-2A

.157 (4.00)

.170 (4.32) TYP.

.030 (0.76) TYP.

.701 (17.80)

.190 (4.83) TYP.

.252 (6.40) Dia.

.228 (5.79)

.244 (6.20)

.095 (2.41)

.032 (0.81)

Tyco Electronics	Alcoswitch	Type	Act. Code P. M5	On	None	On
4-1437559-2	MTL306D	3PDT	3	On	None	On

**4PDT/DP3T**

**MTL406N**

.022 Dp. x .040 W  
(0.55 Dp. x 1.00 W)  
KEYWAY

.086 (2.18)

.039 x .078 (1.00 x 1.98) Oblong Hole

.650 (17.0) UNLOCKED  
.590 (15.0) LOCKED

.217 (5.51) DIA.

26°

.315 (8.00)

.532 (13.50)

1/4-40 UNS-2A

.157 (4.00)

.170 (4.32) TYP.

.030 (0.76) TYP.

.890 (22.60)

.190 (4.83) TYP.

.252 (6.40) Dia.

.228 (5.79)

.244 (6.20)

.095 (2.41)

.032 (0.81)

Tyco Electronics	Alcoswitch	Type	Act. Code P. M5	On	None	On
4-1437559-4	MTL406N	4PDT	4	On	None	On
4-1437559-5	*MTL406PA	DP3T	12	On	On	On

\*Note: PA types have case .100/(2.50) longer than other types.

MTL Series

**Toggle Switches, MT Series, PC Tail, Short Bat Actuator**

SEE PAGE C43 FOR PRODUCT SPECIFICATIONS

For terminal connections refer to Code Chart. (See Page M5-6)

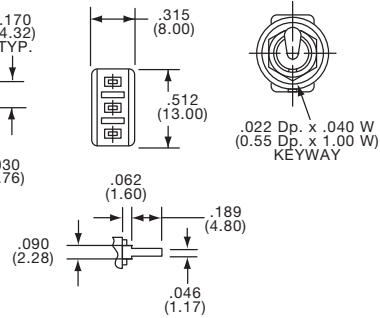
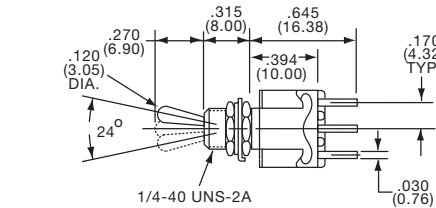
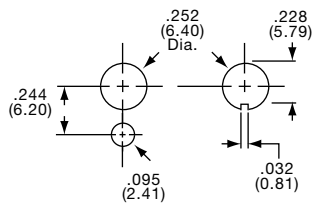

SPDT



MTM106DPC

Tyco Electronics	Alcoswitch	Type	Act. Code	P. M5	↖	⏏	↗
4-1437559-6	MTM106DPC	SPDT	1	On None On			
4-1437559-7	MTM106EPC	SPDT	5	On Off On			
4-1437559-8	MTM106FPC	SPDT	1	On None (On)			

(On) indicates momentary position.

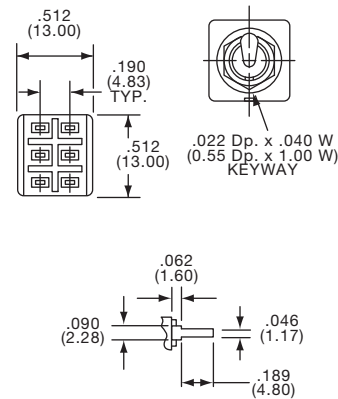
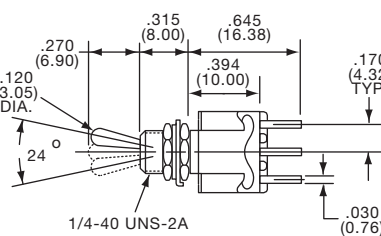
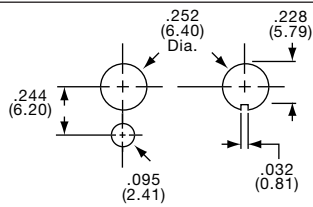

DPDT/SP3T



MTM206NPC

Tyco Electronics	Alcoswitch	Type	Act. Code	P. M5	↖	⏏	↗
4-1437559-9	MTM206NPC	DPDT	2	On None On			
5-1437559-2	MTM206SPC	DPDT	6	(On) Off (On)			
5-1437559-0	*MTM206PAPC	SP3T	11	On On On			

(On) indicates momentary position.  
\*Note: PA types have case .100/(2.50) longer than other types.

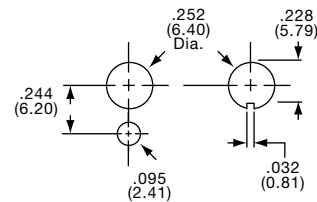
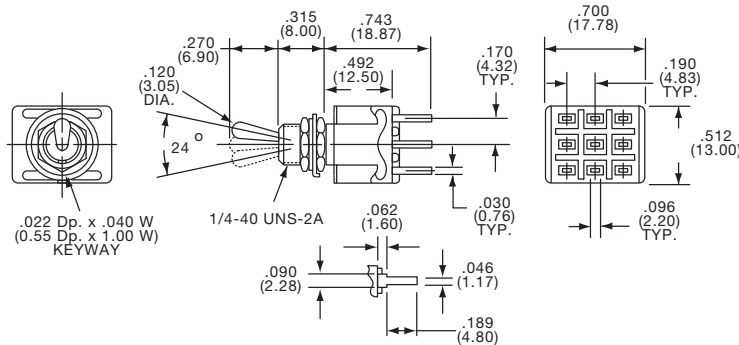

3PDT



MTM306DPC

Tyco Electronics	Alcoswitch	Type	Act. Code	P. M5	↖	⏏	↗
5-1437559-3	MTM306DPC	3PDT	3	On None On			

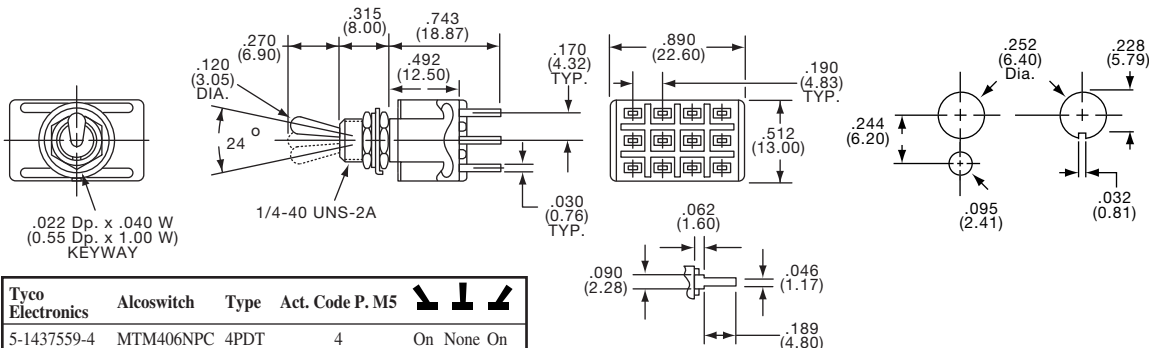

4PDT

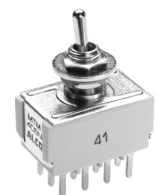

MTM406NPC

Tyco Electronics	Alcoswitch	Type	Act. Code	P. M5	↖	⏏	↗
5-1437559-4	MTM406NPC	4PDT	4	On None On			





**Toggle Switches, MT Series, Right Angle, Long or Short Bat Actuator**

SEE PAGE C52 FOR PRODUCT SPECIFICATIONS

For terminal connections refer to Code Chart. (See Page M5-6)

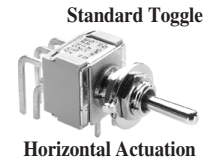
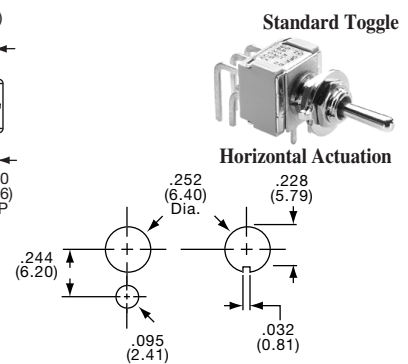
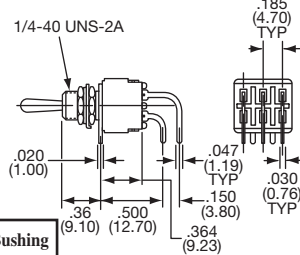
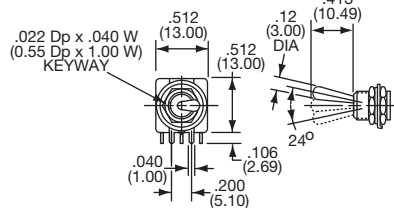
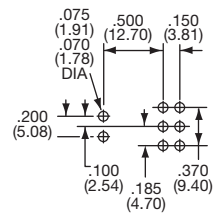

Tyco Electronics	Alcoswitch	Type	Act. Code	P. M5	Toggle	Bushing
5-1437558-6	MTA8206NRA	DPDT	2	On None On	.410	1/4-40
5-1437558-9	MTA8206PRA	DPDT	6	On Off On	.410	1/4-40
	MTA8206RRA	DPDT	2	(On) None (On)	.410	1/4-40

(On) indicates momentary position.

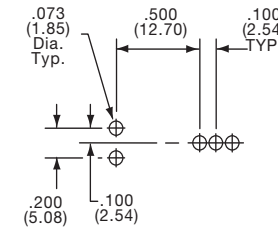
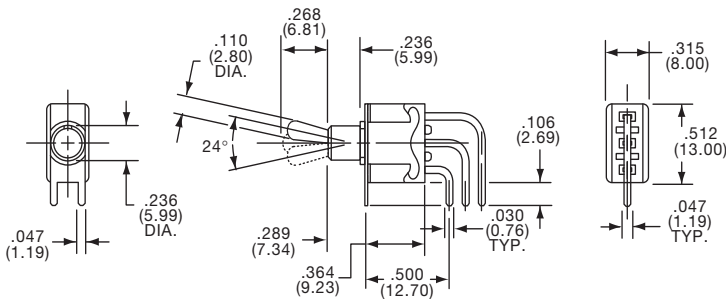

MTM8106DVRA  
Vertical Actuation

Tyco Electronics	Alcoswitch	Type	Act. Code	P. M5	Short Toggle	Bushing
5-1437559-7	MTM8106DVRA	SPDT	1	On None On	.270	.250
5-1437559-9	MTM8106EVRA	SPDT	5	On Off On	.270	.250

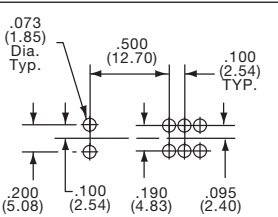
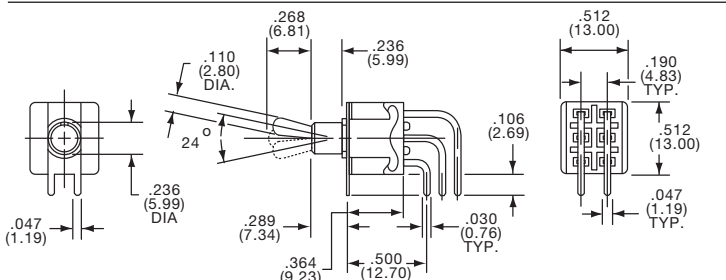

MTM8206NVRA  
Vertical Actuation

Tyco Electronics	Alcoswitch	Type	Act. Code	P. M5	Short Toggle	Bushing
1417566-1	MTM8206NVRA	DPDT	1	On None On	.270	.250
	MTM8206PVRA	DPDT	5	On Off On	.270	.250
147673-2	MTM8206RVRA	DPDT	1	On None (On)	.270	.250

(On) indicates momentary position.

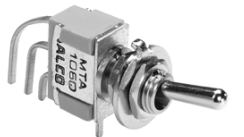
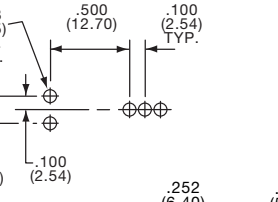
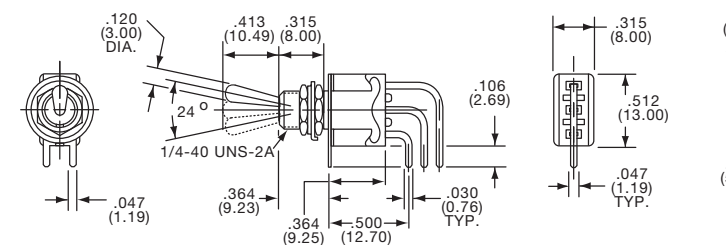

MTA8106DVRA  
Vertical Actuation

Tyco Electronics	Alcoswitch	Type	Act. Code	P. M5	Short Toggle	Bushing
5-1437558-1	MTA8106DVRA	SPDT	1	On None On	.410	1/4-40
147676-1	MTA8106EVRA	SPDT	5	On Off On	.410	1/4-40
	MTA8106FVRA	SPDT	1	On None (On)	.410	1/4-40

(On) indicates momentary position.

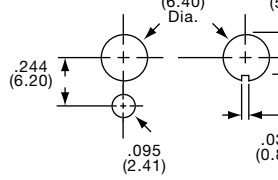

**Toggle Switches, MT Series, Right Angle, Long or Short Bat Actuator**

SEE PAGE C52 FOR PRODUCT SPECIFICATIONS

DPDT



MTA8206NVRA  
Vertical Actuation

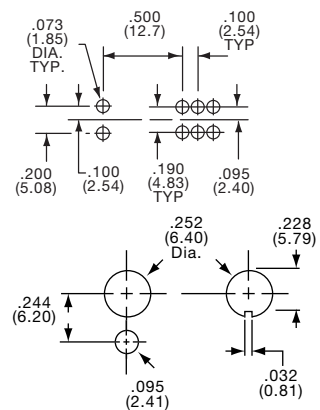
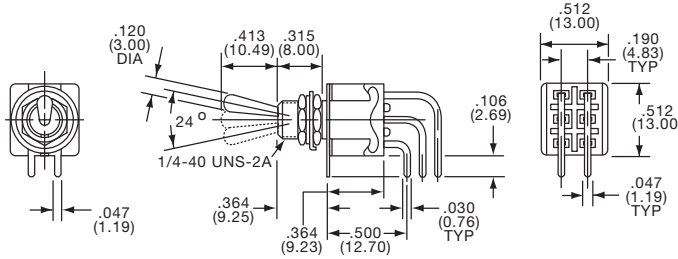

Tyco Electronics	Alcoswitch	Type	Act. Code	P. M5	On	None	Off	Short Toggle	Bushing
5-1437558-7	MTA8206NVRA	DPDT	1		On	None	On	.410	1/4-40
6-1437558-0	MTA8206PVRA	DPST	5		On	Off	On	.410	1/4-40

**Toggle Switches, Hardware and Accessories**

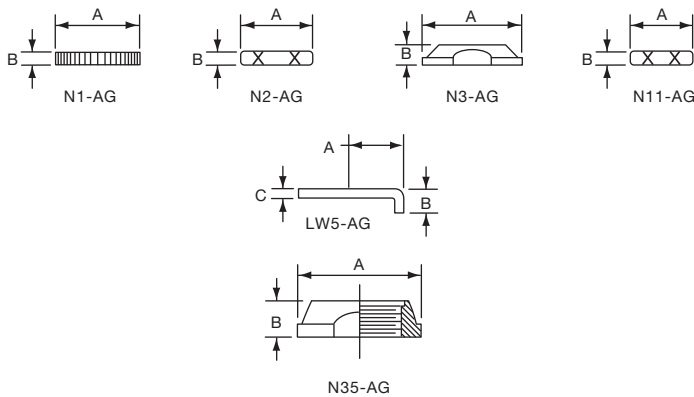

**STANDARD AND DECORATIVE MOUNTING HARDWARE**

Fits all miniature toggle and pushbutton switches with 1/4-40 bushings. N1 and N3 nuts are recommended as styling options.



Tyco Electronics	Alcoswitch	Description	Diameter	Finish	A	Dim. B	C
1437628-7	N1-AG	Knurled Nut	1/4-40	Bright Nickel	.350	.060	
1437561-9	10264-00-120	Hex Nut	1/4-40	Bright Nickel	.312	.062	
1-1437628-3	N3-AG	Dress Nut	1/4-40	Bright Nickel	.460	.090	
1-1437561-2	11106-AG	Hex Nut	10-48	Bright Nickel	.281	.047	
1-1437628-4	N35-AG	Dress Nut	15/32-32	Chrome Plate	.630	.170	
1437628-2	LW1	Int. Tooth Lock Washer	1/4-40	Bright Nickel	.406	.024	
1437628-5	LW5-AG	Locking Ring	1/4"	Bright Nickel	.200	.086	.032
1437628-3	LW12-AG	Lock Washer	No. 10	Bright Nickel	.315	.035	.035

**"PERFECT FIT" DECORATIVE MOUNTING HARDWARE**

Use blind threaded nuts for ultimate appearance. Finger tighten until nut rests on ridge - Final tightening with back-up nut.

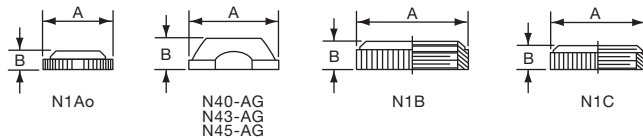

Tyco Electronics	Alcoswitch	Description	Diameter	Finish	Dim. A	Dim. B
1437628-9	N1A	Knurled Nut	1/4-40	Chrome Plate	.315	.080
1-1437628-0	N1B	Knurled Nut	15/32-32	Bright Nickel	.562	.140
1-1437628-1	N1C	Knurled Nut	3/8-32	Bright Nickel	.469	.093
1-1437628-5	N40-AG	Dress Nut	1/4-40	Matte Nickel	.375	.120
1-1437628-6	N43-AG	Dress Nut	1/4-40	Bright Nickel	.375	.120
1-1437628-7	N45-AG	Dress Nut	15/32-32	Chrome Plate	.630	.170





**Toggle Switches, Legend Plates, Boot Seals**

Constructed of .025 gauge brushed aluminum, finished with scratch resistant matte black enamel. Easily readable & aesthetically attractive.

Tyco Electronics	Alcoswitch	Description	Dim.	
			A	B
2-1437628-4	SPA32	On-Off (for 1/4" diameter switch)	.375	.880
2-1437628-6	SPA42	On-Off (for 15/32" diameter switch)	.680	1.125

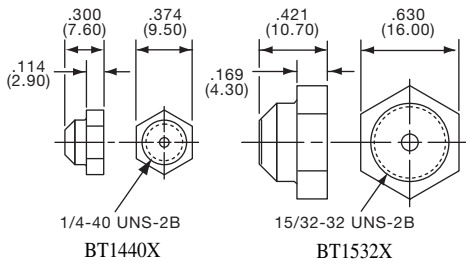

**1/4-40 & 15/32-32 TOGGLE SWITCH BOOT SEALS**

Splashproof seals especially designed for toggle switches having longer actuators. They are also highly recommended for 3-position maintained toggle switches where full-cover boots may have a tendency to pull the toggle back to center. No O-Ring required. These boot seals are not recommended for use with flat toggles.

Tyco Electronics	Alcoswitch	Mount Color	Boot Color	Thread Size	Use With Switch Type
3-1437626-6	BT14400	Black	Black	1/4-40	TT, MTA, Gemini
	BT14402	Red	Red	1/4-40	TT, MTA, Gemini
	BT14408	Gray	Gray	1/4-40	TT, MTA, Gemini
3-1437626-7	BT15320	Black	Black	15/32-32	MTG Series
3-1437626-8	BT15322	Red	Red	15/32-32	MTG Series
3-1437626-9	BT15328	Gray	Gray	15/32-32	MTG Series



BT1440

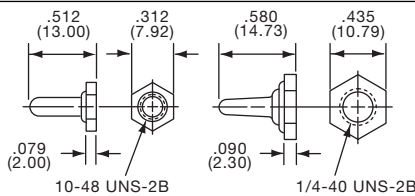

**10-48 & 1/4-40 TOGGLE SWITCH BOOT SEALS**

Splashproof seals designed for "TINY" and miniature switches with bat toggles up to .370" long. A hex nut is integrally bonded to the Neoprene boot. No O-Ring is required.

Tyco Electronics	Alcoswitch	Mount Color	Boot Color	Thread Size	Use With Switch Type
1437626-1	B10480	Black	Black	10-48	TT Series
1437626-2	B10482	Red	Red	10-48	TT Series
1437626-3	B10488	Gray	Gray	10-48	TT Series
1437626-4	B14400	Black	Black	1/4-40	TT, MTA, Gemini
1437626-5	B14402	Red	Red	1/4-40	TT, MTA, Gemini
1437626-6	B14408	Gray	Gray	1/4-40	TT, MTA, Gemini



B14400

B10480

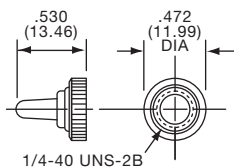

**1/4-40 TOGGLE SWITCH BOOT SEALS**

Splashproof toggle seals having 1/4-40 blind nuts integrally mounted on the Black Neoprene seal. Supplied with captive O-Ring to complete the panel seal. Accepts bat toggles from .375" to .468" long.

Tyco Electronics	Alcoswitch	Mount Color	Boot Color	Thread Size	Use With Switch Type
1-1437626-0	B2100	Nickel	Black	1/4-40	TT, Gemini and MTA Series
1-1437626-1	B2210	Black	Black	1/4-40	TT, Gemini and MTA Series



B2100



B2210

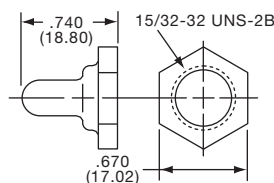

**15/32-32 TOGGLE SWITCH BOOT SEALS**

Splashproof toggle seals incorporating a molded-in hex nut for water tight & dust tight protection. Recommended for standard size toggle switches with short to medium length toggle levers. Replaces standard hardware usually supplied with the switch.

Tyco Electronics	Alcoswitch	Mount Color	Boot Color	Thread Type	Use With Switch Type
1437626-7	B15320	Black	Black	15/32-32	MTG Series, Gemini "T", "T1" Options
1437626-8	B15322	Red	Red	15/32-32	MTG Series, Gemini "T", "T1" Options
1437626-9	B15328	Gray	Gray	15/32-32	MTG Series, Gemini "T", "T1" Options

B15320



**Engineering Notes**



Engineering Notes