

APPLICATION MANUAL

LDO REGULATOR WITH ON/OFF CONTROL TK111xxCS

CONTENTS

1 . DESCRIPTION	2
2 . FEATURES	2
3 . APPLICATIONS	2
4 . PIN CONFIGURATION	2
5 . BLOCK DIAGRAM	2
6 . ORDERING INFORMATION	3
7 . ABSOLUTE MAXIMUM RATINGS (BOTH C AND I RANK IN COMMON)	3
8 . ELECTRICAL CHARACTERISTICS	4
9 . TEST CIRCUIT	8
10 . APPLICATION EXAMPLE	8
11 . TYPICAL CHARACTERISTICS	9
12 . PIN DESCRIPTION	21
13 . APPLICATIONS INFORMATION	22
14 . NOTES	28
15 . OFFICES	28



LDO REGULATOR WITH ON/OFF CONTROL TK111xxCS

1. DESCRIPTION

TK111xxC is an integrated circuit of the silicon monolithic bipolar structure, and the regulator of the low saturation output type with very little quiescent current (63μA).

The PNP power transistor is Built-in to. The I/O voltage difference when the current of Typ.200mA is supplied to the system is 0.2V. The voltage source can be effectively used.

Therefore, It is the best for the battery use set.

The on/off function is Built-in to IC. The current at standing-by mode becomes slight (pA level).

1.5 to 10.0V is arranged to the output voltage in 0.1V step. The output voltage is trimmed in high accuracy. The best voltage for the set used will be able to be selected.

The over current sensor circuit and the reverse-bias over current obstruction circuit are Built-in to.

It is a design not broken because an ESD is also high. It is possible to use (*O) at ease.

When mounting on PCB, the loss becomes about 500mW though the package is very small.

TK111xxC uses the circuit with very high stability in DC and AC.

The capacitor on the output side is steady in 0.1μF (1.8V≤Vout). The kind of this capacitor is not asked. It is possible to use every type capacitor.

However, a good characteristic is shown the more overall larger this capacitor is.

The ripple rejection is 84dB at 400Hz and 80dB at 1kHz.

2. FEATURES

- Very good stability $C_L=0.1\mu\text{F}$ is steady enough. Any type can be used. ($1.8\text{V}\leq V_{\text{OUT}}$)
- Very low dropout Voltage. $V_{\text{DROP}}=120\text{mV}$ at 100mA
- High Precision output voltage ($\pm 1.5\%$ or $\pm 50\text{mV}$)
- Good ripple rejection ratio(80dB at 1kHz)
- Wide operating voltage range (1.8V to 14V)
- Built-in Short circuit protection
- Peak output current is 320mA.(0.3V down point)
- Built-in thermal shutdown
- Very low quiescent current ($I_{\text{OUT}}=63\mu\text{A}$ at $I_{\text{OUT}}=0\text{mA}$)
- Available very low noise application
- Built-in on/off control (0.1μA Max Standby current) High On
- Very small surface mount package
- Built-in reverse bias over current protection

3. APPLICATIONS

- Any Electronic Equipment
- Battery Powered Systems
- Mobile Communication

4. PIN CONFIGURATION

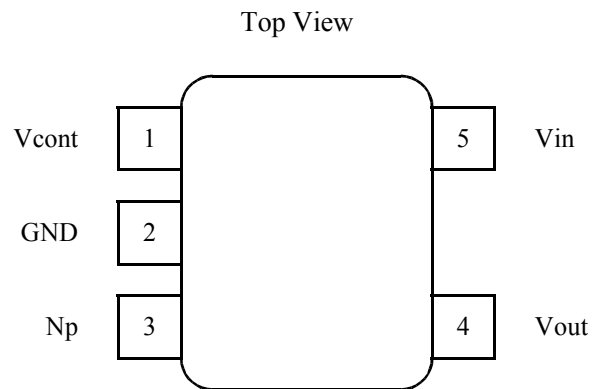

5. BLOCK DIAGRAM

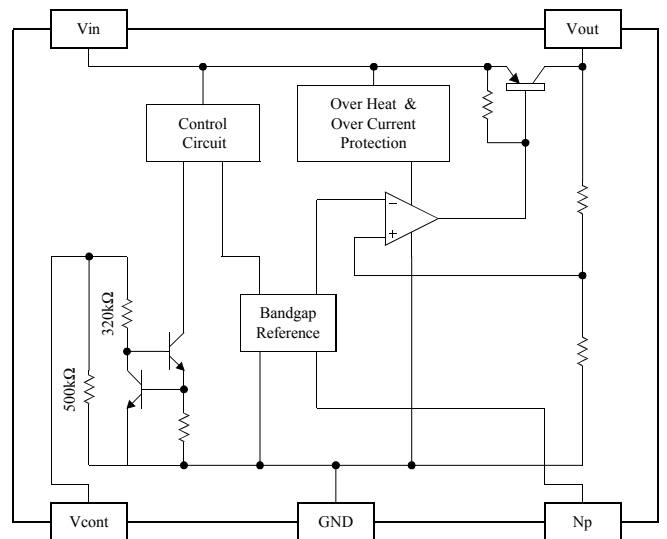

6. ORDERING INFORMATION

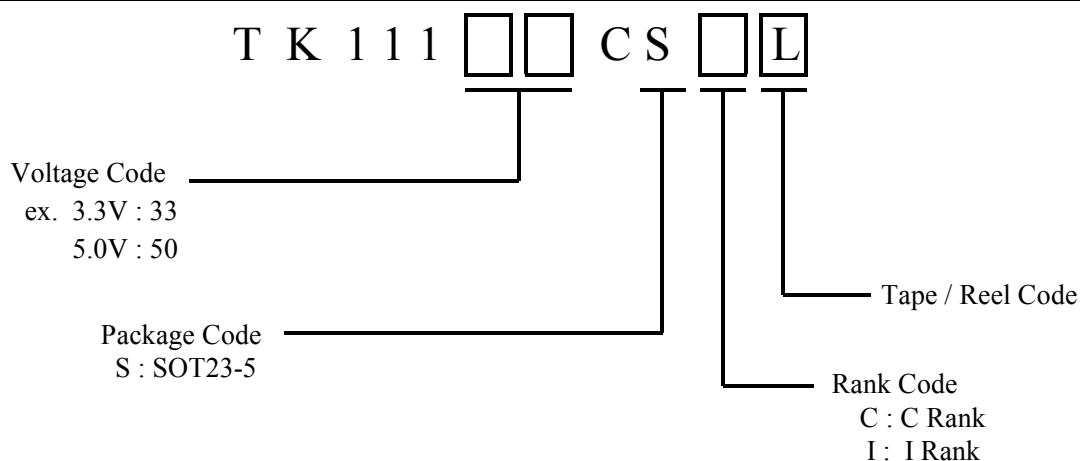

Standard Voltage (net multiplication bold-faced type)

TK11115CS	TK11116CS	TK11117CS	TK11118CS	TK11119CS
TK11120CS	TK11121CS	TK11122CS	TK11123CS	TK11124CS
TK11125CS	TK11126CS	TK11127CS	TK11128CS	TK11129CS
TK11130CS	TK11131CS	TK11132CS	TK11133CS	TK11134CS
TK11135CS	TK11136CS	TK11137CS	TK11138CS	TK11139CS
TK11140CS	TK11141CS	TK11142CS	TK11143CS	TK11144CS
TK11145CS	TK11146CS	TK11147CS	TK11148CS	TK11149CS
TK11150CS				

*Please contact your authorized TOKO representatives for voltage availability.
If you need the voltage except the above table, please contact TOKO.

7. ABSOLUTE MAXIMUM RATINGS (BOTH C AND I RANK IN COMMON)

T_A=25°C

Parameter	Symbol	Rating	Units	Conditions
Absolute Maximum Ratings				
Supply Voltage	V _{CC,MAX}	-0.4 ~ 16	V	
Reverse Bias	V _{REV,MAX}	-0.4 ~ 6	V	V _{out} ≤ 2.0V
		-0.4 ~ 12	V	2.1V ≤ V _{out}
NP pin Voltage	V _{NP,MAX}	-0.4 ~ 5	V	
Control pin Voltage	V _{CONT,MAX}	-0.4 ~ 16	V	
Storage Temperature Range	T _{STG}	-55 ~ 150	°C	
Power Dissipation	P _D	500 when mounted on PCB	mW	Internal Limited T _J =150°C *
Operating Condition				
Operating Temperature Range	T _{OP}	-40 ~ 85	°C	
Operating Voltage Range	V _{OP}	2.1 ~ 14	V	
		1.8 ~ 14	V	T _{OP} = -30 ~ 80°C
Short Circuit Current	I _{SHORT}	360	mA	

* P_D must be decreased at rate of 4.0mW/°C for operation above 25°C.
The maximum ratings are the absolute limitation values with the possibility of the IC breakage.
When the operation exceeds this standard quality cannot be guaranteed.

8. ELECTRICAL CHARACTERISTICS

8-1. Electrical Characteristics of the C rank

$V_{IN}=V_{OUT,TYP}+1V, V_{CONT}=1.8V, T_A=25^{\circ}C$

Parameter	Symbol	Value			Units	Conditions
		MIN	TYP	MAX		
Output voltage	V_{OUT}	See table 1				
Line regulation	$L_{IN}R_{EG}$		0.0	5	mV	$V_{IN}=V_{OUT,TYP}+1V$ ---- $V_{OUT,TYP}+6V$ $\Delta V=5V$
Load regulation	$L_{OA}R_{EG}$		(11)	(28)	mV	$5mA < I_{OUT} < 100mA$ note 1
			(27)	(64)	mV	$5mA < I_{OUT} < 200mA$ note 1
Drop-out voltage	V_{DROP}		80	140	mV	$I_{OUT}=50mA$
			120	210	mV	$I_{OUT}=100mA$
			200	350	mV	$I_{OUT}=200mA$ ($2.4V \leq V_{OUT}$)
			230	350	mV	$I_{OUT}=180mA$ ($2.1V \leq V_{OUT} < 2.4V$)
		$1.5V \leq V_{OUT} \leq 2.0V$: No regulation			Because of $V_{opMin}=1.8V$	
Maximum output current	$I_{OUT,MAX}$	240	320		mA	When ($V_{OUT,TYP} \times 0.9$)
Consumption current	I_{CC}		63	100	μA	$I_{OUT}=0mA$ Except I_{CONT}
Standing by current	$I_{STANDBY}$		0.0	0.1	μA	$V_{CONT}=0V$ off state
Quiescent current	I_Q		1.0	1.8	mA	$I_{OUT}=50mA$
Control terminal Specification (Pull down resistor =500k (Note 2))						
Control current	I_{CONT}		5	15	μA	$V_{CONT}=1.8V$ on state
Control voltage	V_{CONT}	1.8			V	on state, $T_{OP} = -40 \sim 85^{\circ}C$
				0.35	V	off state, $T_{OP} = -40 \sim 85^{\circ}C$
		1.6			V	on state, $T_{OP} = -30 \sim 80^{\circ}C$
				0.6	V	off state, $T_{OP} = -30 \sim 80^{\circ}C$
Np treminal Voltage	V_{NP}		1.28		V	
Output Voltage / Temp.	V_{OUT}/T_A	Typ=35 ppm/ $^{\circ}C$			Reference Value	
Output noise	V_{NOISE}	Typ=0.14 $\mu V/\sqrt{Hz}$ at 1kHz			Reference Value	

Note 1: This value depends on the output voltage. (It is a value of $V_{OUT}=3V$ device.)

This item improves in a low voltage device.

Note 2: The input current decreases to the pA level by connecting control terminal to GND.(Off state)Pull-down resistor is 500k Ω .

General Note: Limits are guaranteed by production testing or correction techniques using Statistical Quality Control (SQC) methods. Unless otherwise noted. $V_{IN}=V_{OUT,TYP}+1V$; $I_{OUT}=1mA$ ($T_J=25^{\circ}C$) The operation of $-40^{\circ}C \sim +85^{\circ}C$ is guaranteed in the design by a usual inspection.

General Note: Exceeding the “Absolute Maximum Rating “ may damage the device

General Note: Connecting a capacitor to the noise bypass pin can decrease the output noise voltage

General Note: Output noise is Typ=38 μV_{rms} at BW400-80kHz. ($V_{OUT}=3V$ device)

General Note: The ripple rejection is Typ=84dB at 400Hz and Typ=80dB at 1kHz. ($V_{OUT}=3V$ device)

[$CL=1.0\mu F, C_{np}=0.01\mu F, V_{nois}=200mV_{RMS}, V_{in}=V_{OUT,TYP}+1.5v, I_{out}=10mA$]

Table 1: Output voltages of the C rank

$I_{OUT}=5mA, T_A=25^{\circ}C$

Output voltage	Voltage code	V _{OUT.MIN}	V _{OUT.MAX}	Test voltage	Output voltage	Voltage code	V _{OUT.MIN}	V _{OUT.MAX}	Test voltage
1.5V	15	1.450V	1.550V	2.5V	3.4V	34	3.349V	3.451V	4.4V
1.6	16	1.550	1.650	2.6	3.5	35	3.447	3.553	4.5
1.7	17	1.650	1.750	2.7	3.6	36	3.546	3.654	4.6
1.8	18	1.750	1.850	2.8	3.7	37	3.644	3.756	4.7
1.9	19	1.850	1.950	2.9	3.8	38	3.743	3.857	4.8
2.0	20	1.950	2.050	3.0	3.9	39	3.841	3.959	4.9
2.1	21	2.050	2.150	3.1	4.0	40	3.940	4.060	5.0
2.2	22	2.150	2.250	3.2	4.1	41	4.038	4.162	5.1
2.3	23	2.250	2.350	3.3	4.2	42	4.137	4.263	5.2
2.4	24	2.350	2.450	3.4	4.3	43	4.235	4.365	5.3
2.5	25	2.450	2.550	3.5	4.4	44	4.334	4.466	5.4
2.6	26	2.550	2.650	3.6	4.5	45	4.432	4.568	5.5
2.7	27	2.650	2.750	3.7	4.6	46	4.531	4.669	5.6
2.8	28	2.750	2.850	3.8	4.7	47	4.629	4.771	5.7
2.9	29	2.850	2.950	3.9	4.8	48	4.728	4.872	5.8
3.0	30	2.950	3.050	4.0	4.9	49	4.826	4.974	5.9
3.1	31	3.050	3.150	4.1	5.0	50	4.925	5.075	6.0
3.2	32	3.150	3.250	4.2					
3.3	33	3.250	3.350	4.3					

The output voltage table indicates the standard value when manufactured.

8-2. Electrical Characteristics of the I rank

Boldface types apply over the full operating temperature range. (-40°C~85°C)

$$V_{IN}=V_{OUT,TYP}+1V, I_{OUT}=5mA, T_A=-40^{\circ}C\sim 85^{\circ}C$$

Parameter	Symbol	Value			Units	Conditions
		MIN	TYP	MAX		
Output voltage	V_{OUT}	See table 1				
Line regulation	$L_{IN}R_{EG}$		0.0	5 8	mV	$V_{IN}=V_{OUT,TYP}+1V$ ---- $V_{OUT,TYP}+6V$ $\Delta V=5V$
Load regulation	$L_{OA}R_{EG}$		(11)	(28) (34)	mV	$5mA < I_{OUT} < 100mA$ note 1
			(27)	(64) (90)	mV	$5mA < I_{OUT} < 200mA$ note 1
Drop-out voltage	V_{DROP}		80	140 180	mV	$I_{OUT}=50mA$
			120	210 270	mV	$I_{OUT}=100mA$
			200	350 390	mV	$I_{OUT}=200mA$ ($2.4V \leq V_{OUT}$)
			230	350 390	mV	$I_{OUT}=180mA$ ($2.1V \leq V_{OUT} < 2.4V$)
		$1.5V \leq V_{OUT} \leq 2.0V$: No regulation			Because of $V_{opMin}=2.1V$	
Maximum output current	$I_{OUT,MAX}$	240 220	320		mA	When ($V_{OUT,TYP} \times 0.9$)
Consumption current	I_{CC}		63	100 120	μA	$I_{OUT}=0mA$ Except I_{cont}
Standing by current	$I_{STANDBY}$		0.0	0.1 0.5	μA	$V_{CONT}=0V$ off state
Quiescent current	I_Q		1.0	1.8 2.2	mA	$I_{OUT}=50mA$
Control terminal Specification (Pull down resistor =500k (Note 2))						
Control current	I_{CONT}		5	15 15	μA	$V_{CONT}=1.8V$ on state
Control voltage	V_{CONT}	1.8			V	on state
				0.35	V	off state
Np treminal Voltage	V_{NP}		1.28		V	
Vo	V_{OUT}/T_A	Typ=25 ppm/°C			Reference Value	
Out put noise	V_{NOISE}	Typ=0.14 $\mu V/\sqrt{Hz}$ at 1kHz			Reference Value	

Note 1: This value depends on the output voltage. (It is a value of $V_{out}=3V$ device.)

Note 2: The input current decreases to the pA level by connecting control terminal to GND.(Off state)Pull-down resistor is 500k Ω .

General Note: Limits are guaranteed by production testing or correction techniques using Statistical Quality Control (SQC) methods. Unless otherwise noted. $V_{IN}=V_{OUT,TYP}+1V$; $I_{OUT}=1mA(T_J=25^{\circ}C)$ The operation of $-40^{\circ}C$ to $+85^{\circ}C$ is guaranteed in the design by a usual inspection.

General Note: Exceeding the “Absolute Maximum Rating “ may damage the device

General Note: Connecting a capacitor to the noise bypass pin can decrease the output noise voltage

General Note: Output noise is Typ=38 μV_{rms} at BW400-80kHz. ($V_{OUT}=3V$ device)

General Note: The ripple rejection is Typ=84dB at 400Hz and Typ=80dB at 1kHz. ($V_{OUT}=3V$ device)

$$[CL=1.0\mu F, C_{np}=0.01\mu F, V_{nois}=200mV_{RMS}, V_{in}=V_{out,TYP}+1.5v, I_{out}=10mA]$$

Table 2: Output voltages of the I rank

Boldface types apply over the full operating temperature range. ($T_a = -40 \sim +85^\circ\text{C}$) $I_{OUT} = 5\text{mA}$

Output voltage	Voltage code	V_{OUT_MIN}	V_{OUT_MAX}	Test voltage	Output voltage	Voltage code	V_{OUT_MIN}	V_{OUT_MAX}	Test voltage
1.5V	15	1.450V 1.420	1.550V 1.580	2.5V	3.4 V	34	3.349 V 3.315	3.451 V 3.485	4.4 V
1.6	16	1.550 1.520	1.650 1.680	2.6	3.5	35	3.447 3.412	3.553 3.588	4.5
1.7	17	1.650 1.620	1.750 1.780	2.7	3.6	36	3.546 3.510	3.654 3.690	4.6
1.8	18	1.750 1.720	1.850 1.880	2.8	3.7	37	3.644 3.607	3.756 3.793	4.7
1.9	19	1.850 1.820	1.950 1.980	2.9	3.8	38	3.743 3.705	3.857 3.895	4.8
2.0	20	1.950 1.920	2.050 2.080	3.0	3.9	39	3.841 3.802	3.959 3.998	4.9
2.1	21	2.050 2.020	2.150 2.180	3.1	4.0	40	3.940 3.900	4.060 4.100	5.0
2.2	22	2.150 2.120	2.250 2.280	3.2	4.1	41	4.038 3.997	4.162 4.203	5.1
2.3	23	2.250 2.220	2.350 2.380	3.3	4.2	42	4.137 4.095	4.263 4.305	5.2
2.4	24	2.350 2.320	2.450 2.480	3.4	4.3	43	4.235 4.192	4.365 4.408	5.3
2.5	25	2.450 2.420	2.550 2.580	3.5	4.4	44	4.334 4.290	4.466 4.510	5.4
2.6	26	2.550 2.520	2.650 2.680	3.6	4.5	45	4.432 4.387	4.568 4.613	5.5
2.7	27	2.650 2.620	2.750 2.780	3.7	4.6	46	4.531 4.485	4.669 4.715	5.6
2.8	28	2.750 2.720	2.850 2.880	3.8	4.7	47	4.629 4.582	4.771 4.818	5.7
2.9	29	2.850 2.820	2.950 2.980	3.9	4.8	48	4.728 4.680	4.872 4.920	5.8
3.0	30	2.950 3.920	3.050 3.080	4.0	4.9	49	4.826 4.777	4.974 5.023	5.9
3.1	31	3.050 3.020	3.150 3.180	4.1	5.0	50	4.925 4.875	5.075 5.125	6.0
3.2	32	3.150 3.120	3.250 3.280	4.2					
3.3	33	3.250 3.217	3.350 3.383	4.3					

The output voltage table indicates the standard value when manufactured.

9. TEST CIRCUIT

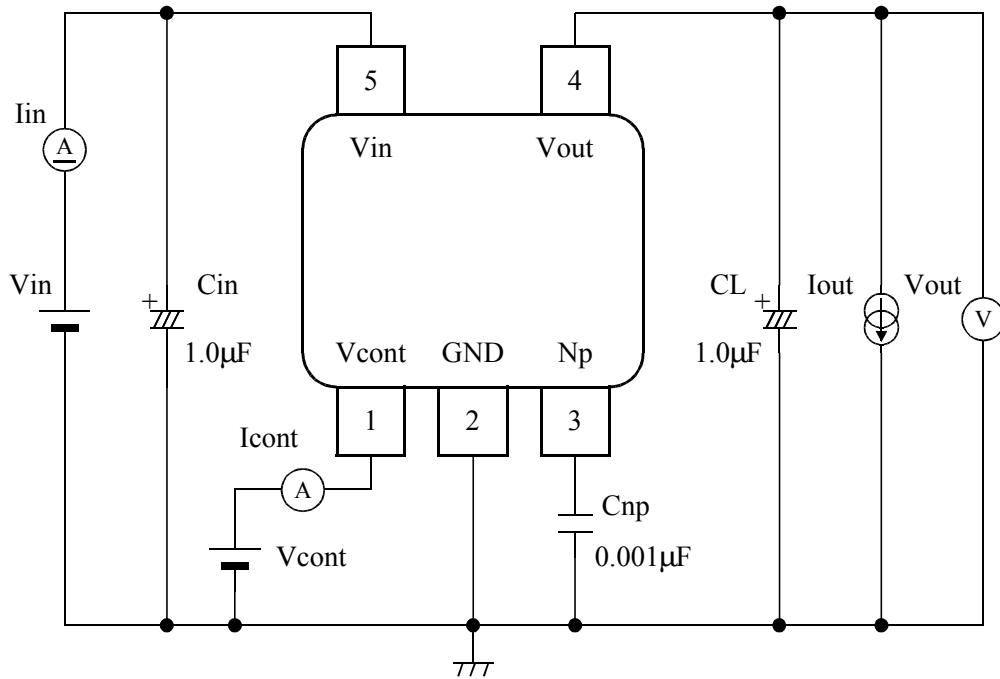

Note : Electrical Characteristics are applied for the test circuit above. ($C_{in}=1.0\mu F$ (Tantalum) , $C_L=1.0\mu F$ (Tantalum) , $C_{np}=0.001\mu F$ (Ceramic))
 In the application , both of ceramic capacitor and tantalum capacitor are available to use as C_{in} , C_L and C_{np} at $I_{out} \geq 0.5mA$.

10. APPLICATION EXAMPLE

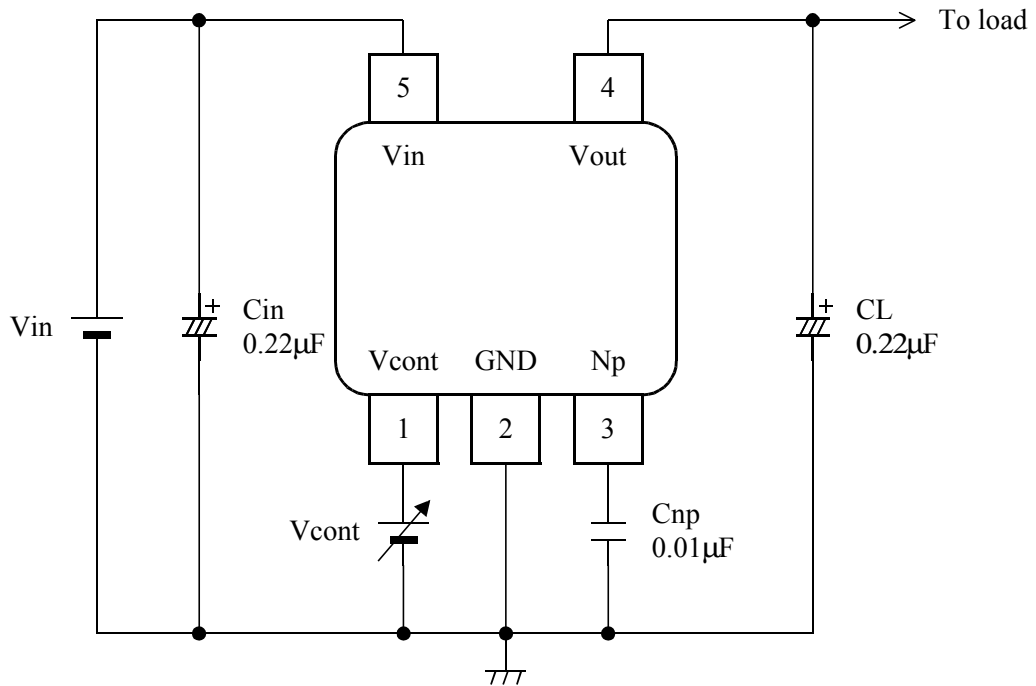

11. TYPICAL CHARACTERISTICS

11-1. DC characteristics

Line Regulation

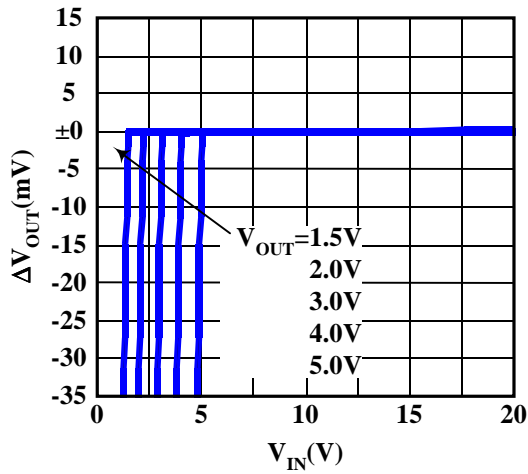

Load Regulation

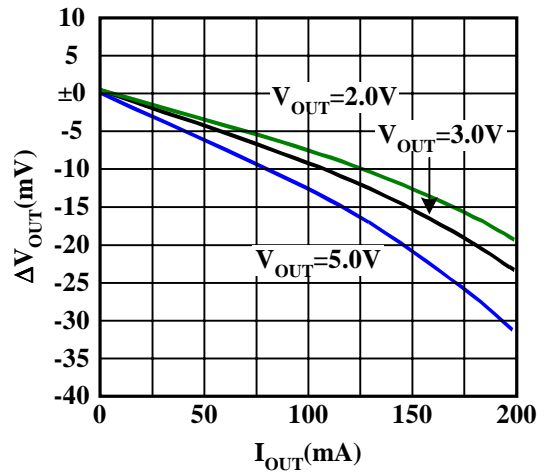

Stability Point
I_{OUT}=0 to 200mA

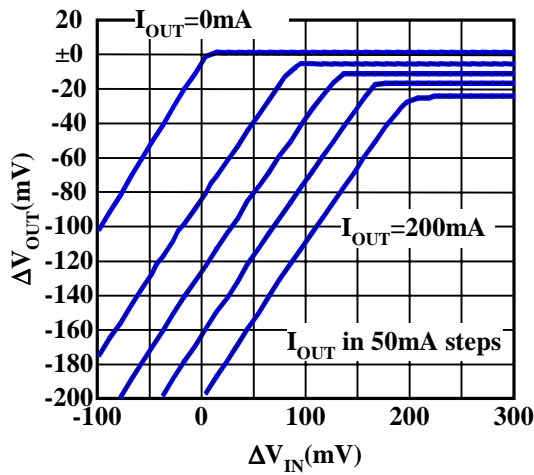

Dropout Voltage versus Output Current

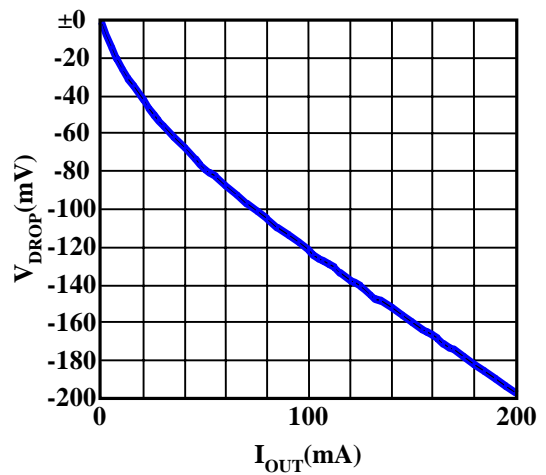

Short Circuit Current

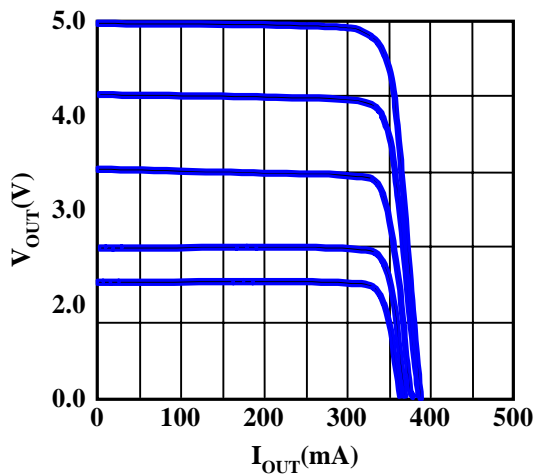

Maximum Output Current in low voltage
(TK11115CS~TK11124CS)

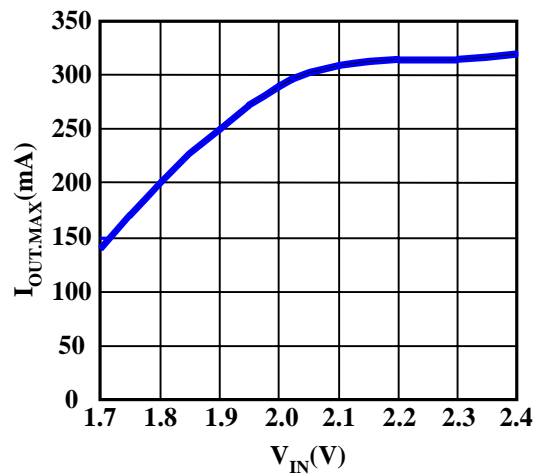

■ Reverse bias Current

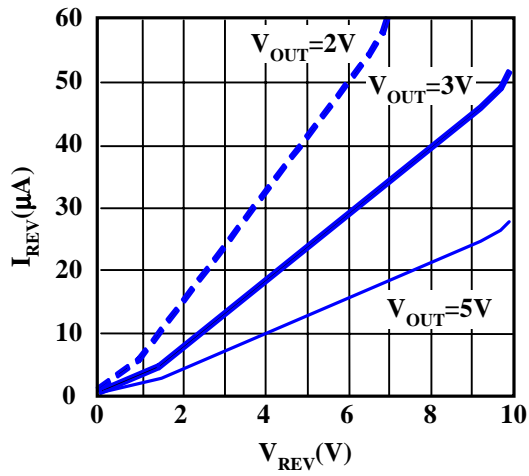

■ V_{IN} versus I_{IN} (Off state)

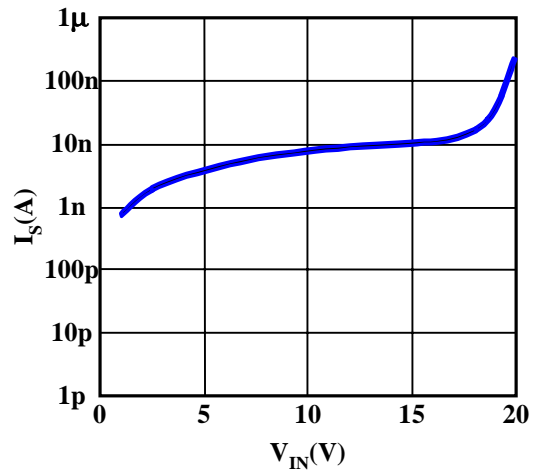

■ Control Current versus Control Voltage

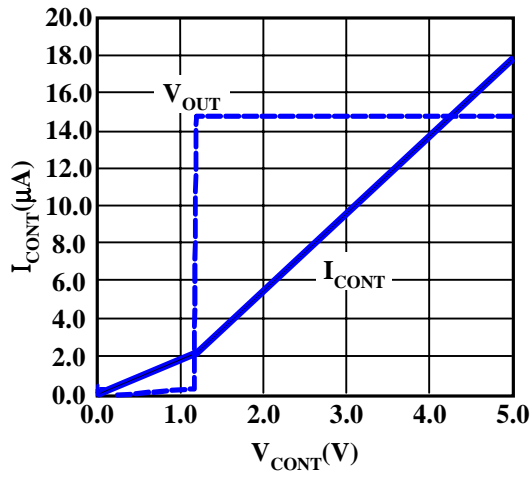

■ Quiescent Current versus Output Current

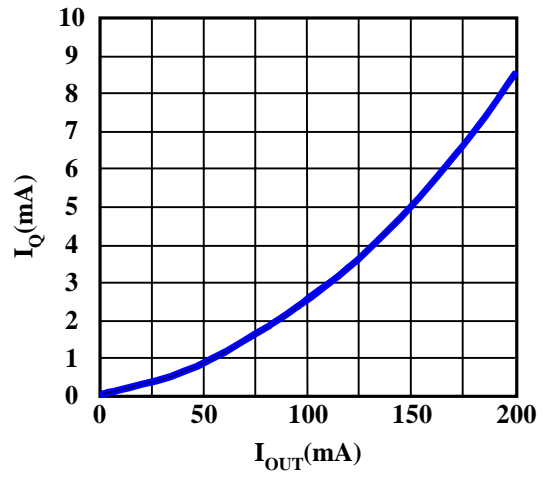

V_{IN} , I_{OUT} versus V_{OUT} of the low output voltage devices

■ Output Voltage versus Input Voltage of the TK11115CS

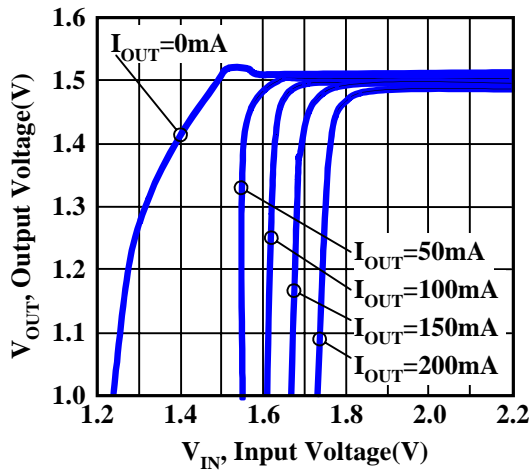

■ Output Voltage versus Output Current of the TK11115CS

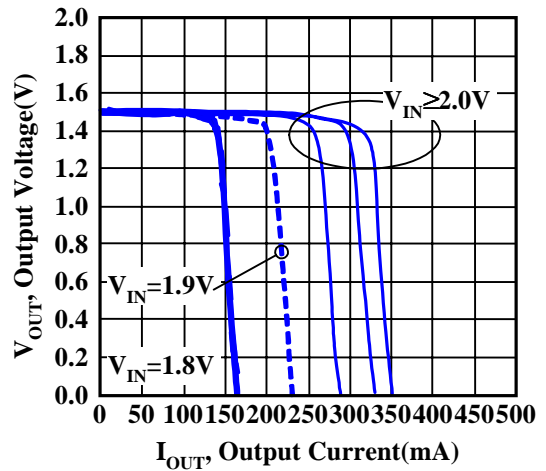

■ Output Voltage versus Input Voltage of the TK11118CS

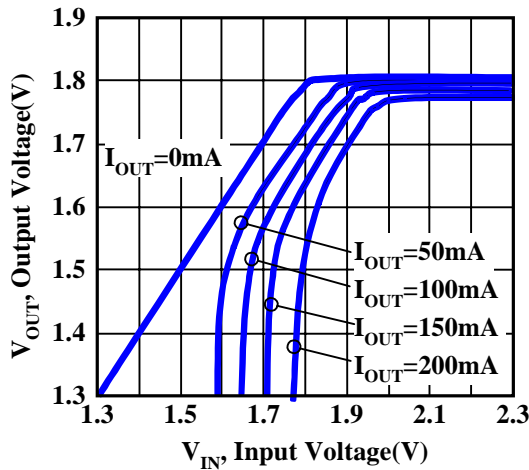

■ Output Voltage versus Output Current of the TK11118CS

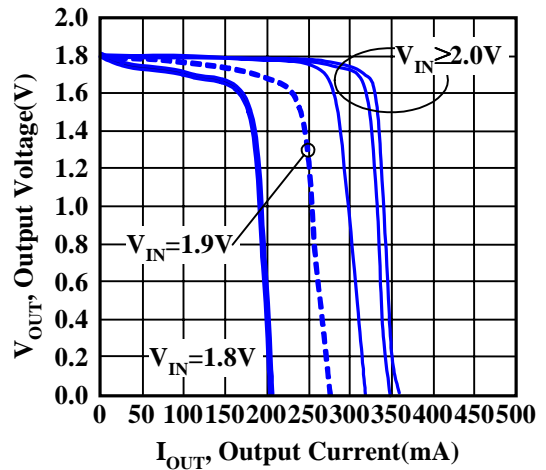

■ Output Voltage versus Input Voltage of the TK11120CS

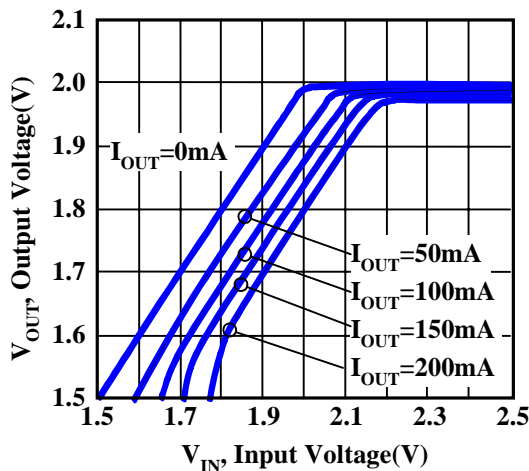

■ Output Voltage versus Output Current of the TK11120CS

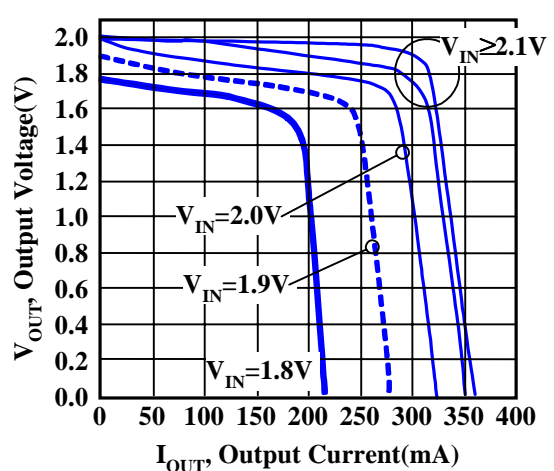

11-2. . Temperature characteristics

■ Maximum Output Current versus Ambient Temperature

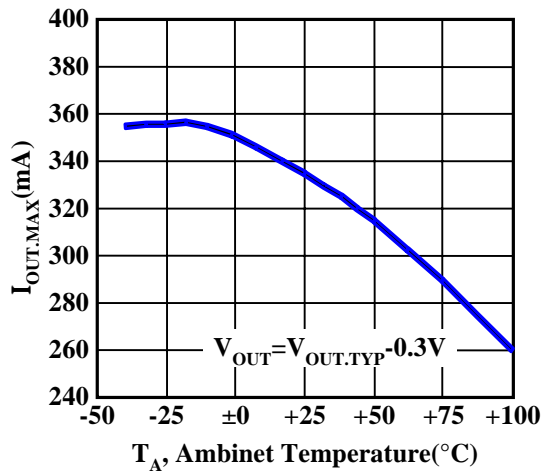

■ Quiescent Current versus Ambient Temperature

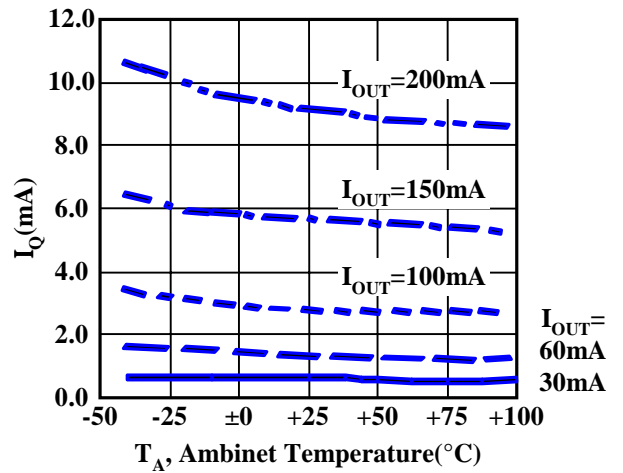

■ Dropout Voltage versus Ambient Temperature

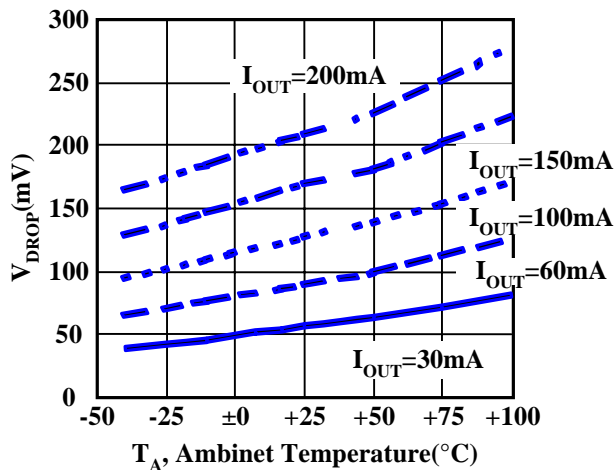

■ Control Current versus Ambient Temperature

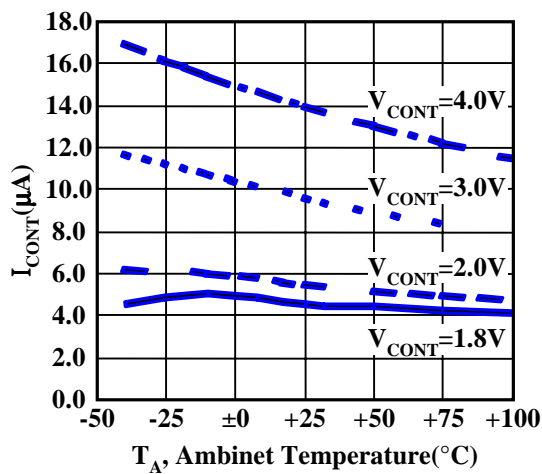

■ Control Voltage versus Ambient Temperature

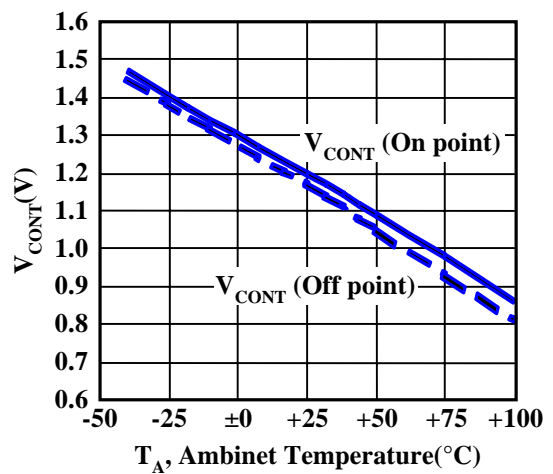

Temperature characteristics(Vout)

■ ΔV_{OUT} versus Ambient Temperature of the TK11115CS ■ ΔV_{OUT} versus Ambient Temperature of the TK11120CS

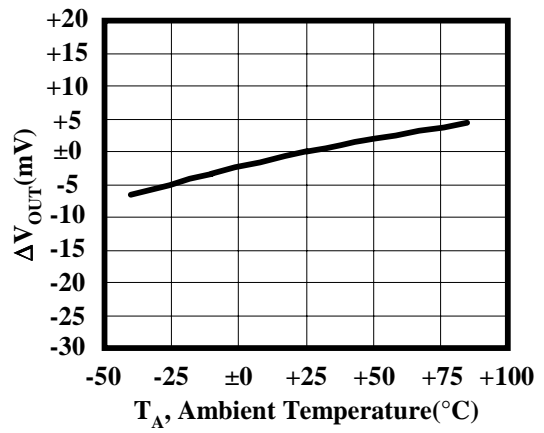
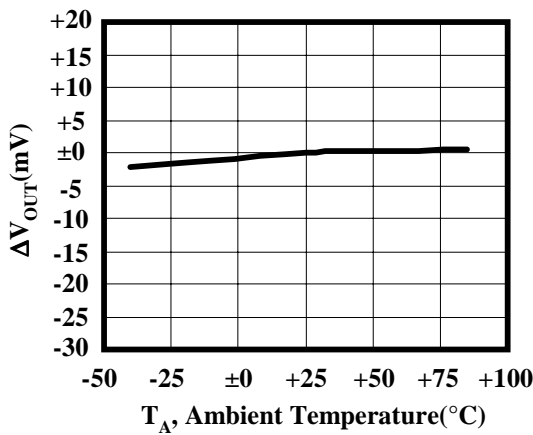

■ ΔV_{OUT} versus Ambient Temperature of the TK11130CS ■ ΔV_{OUT} versus Ambient Temperature of the TK11133CS

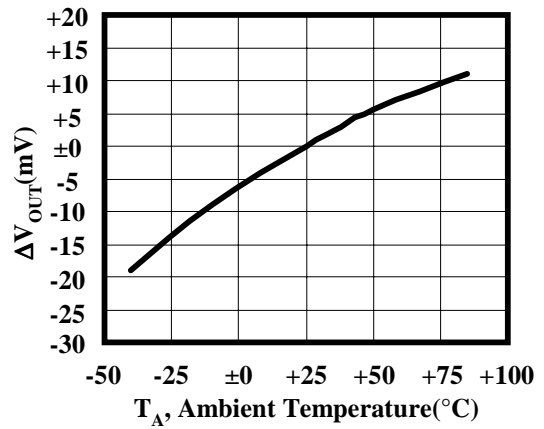
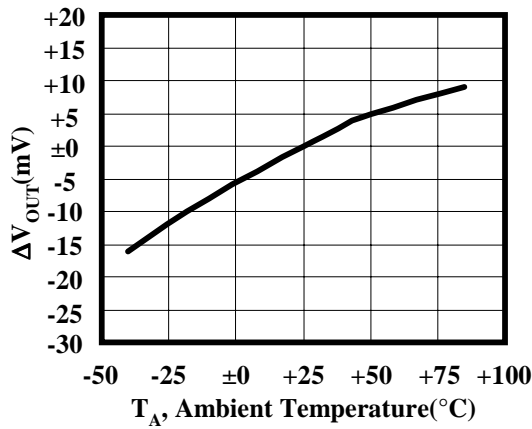

■ ΔV_{OUT} versus Ambient Temperature of the TK11140CS ■ ΔV_{OUT} versus Ambient Temperature of the TK11150CS

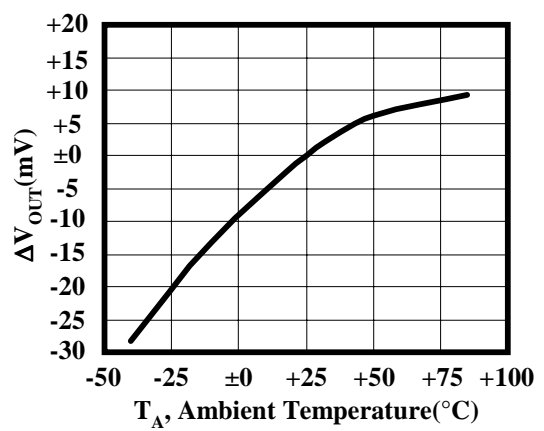
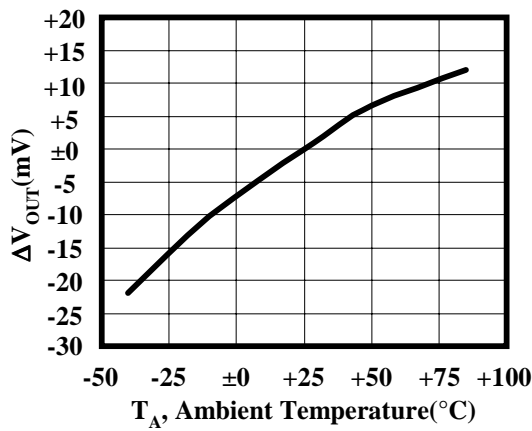

Temperature characteristics (Load Regulation)

■ ΔV_{OUT} versus Ambient Temperature of the TK11115CS ■ ΔV_{OUT} versus Ambient Temperature of the TK11120CS

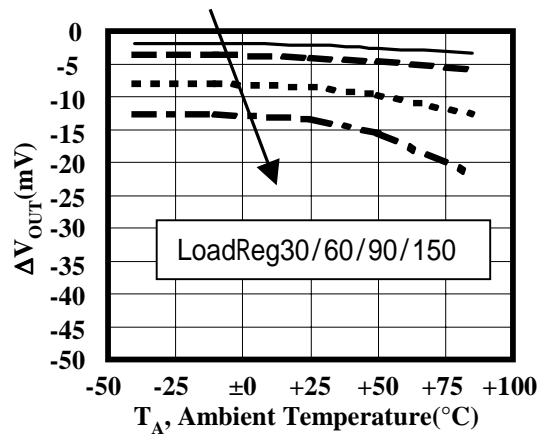
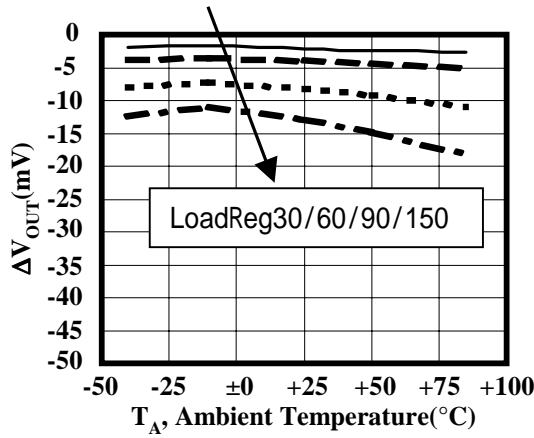

■ ΔV_{OUT} versus Ambient Temperature of the TK11130CS ■ ΔV_{OUT} versus Ambient Temperature of the TK11133CS

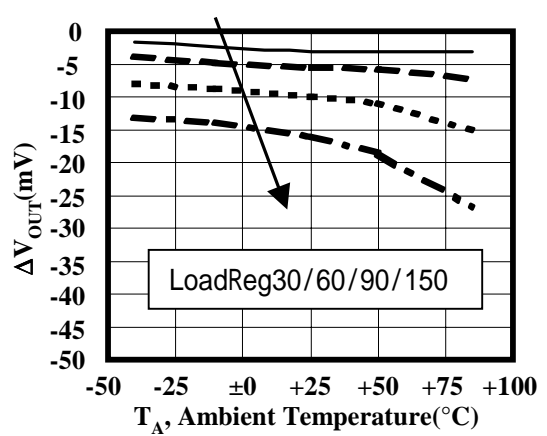
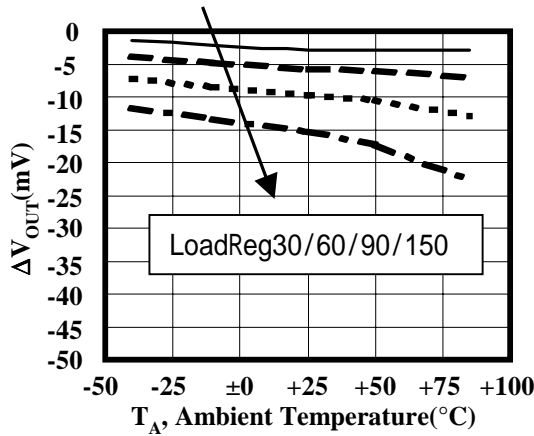

■ ΔV_{OUT} versus Ambient Temperature of the TK11140CS ■ ΔV_{OUT} versus Ambient Temperature of the TK11150CS

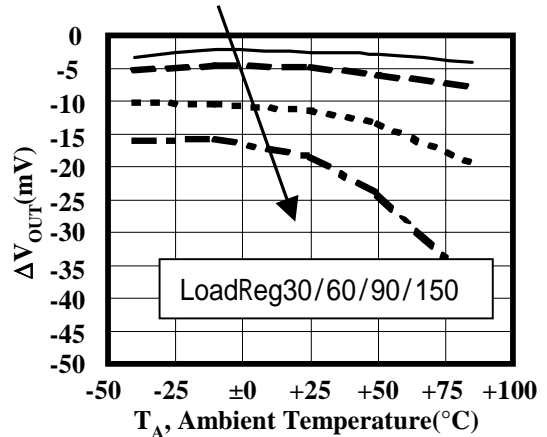
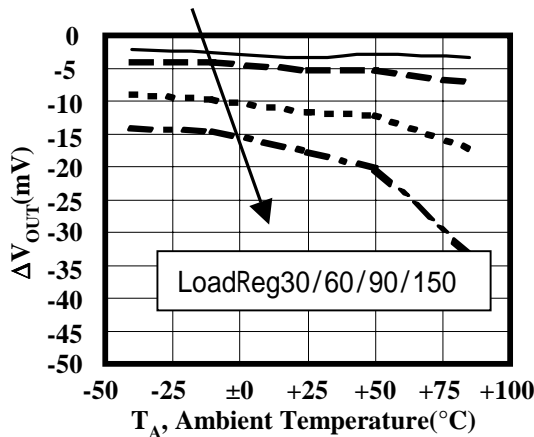

11-3. Ripple rejection (TK11130CS)

■ $C_L=0.22\mu\text{F}$, $1.0\mu\text{F}$: MLCC

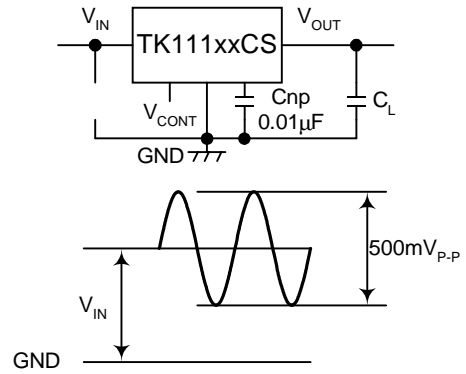
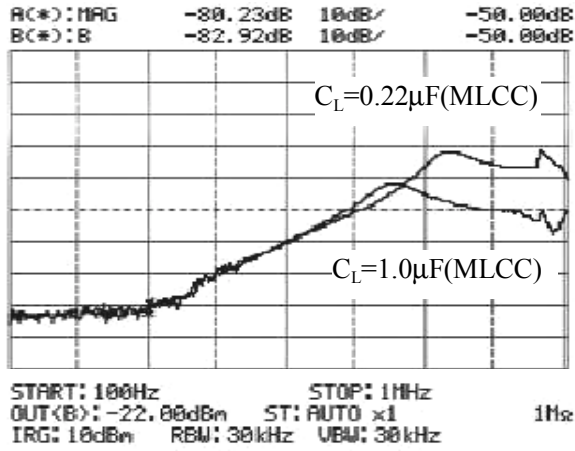

$V_{IN}=5.0\text{V}$ ($V_{IN}=V_{OUT, \text{Typ}}+2\text{V}$)
 $V_{OUT}=3.0\text{V}$, $I_{OUT}=10\text{mA}$
 $V_R=500\text{mV}_{p,p}$, $f=100\text{Hz}$ to 1MHz , $C_{np}=0.01\mu\text{F}$

■ $C_L=1.0\mu\text{F}$, $10\mu\text{F}$: MLCC

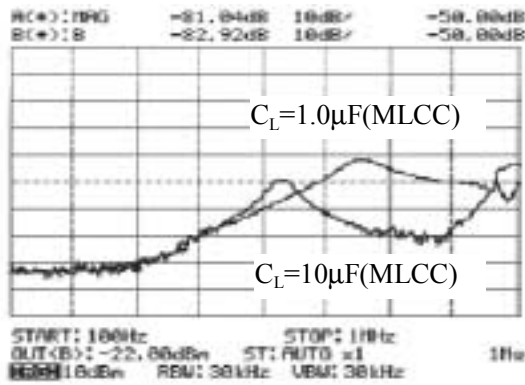

■ $C_{np}=0.1\mu\text{F}$, $0.01\mu\text{F}$: MLCC

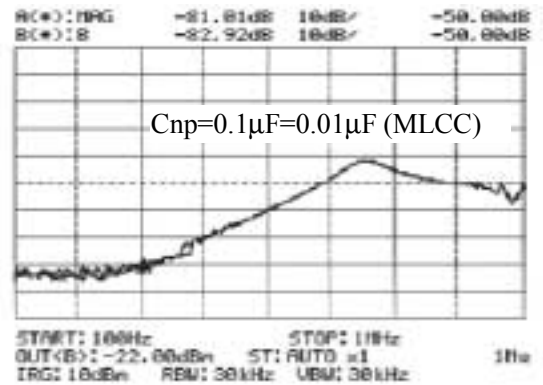

The ripple rejection characteristic depends on the characteristic and the capacity value of the capacitor connected with the output side. The RR characteristic of 50kHz or more changes greatly in the capacitor on the output side and PCB pattern. Please confirm stability if necessary while operated.

■ Ripple Rejection versus Output Voltage

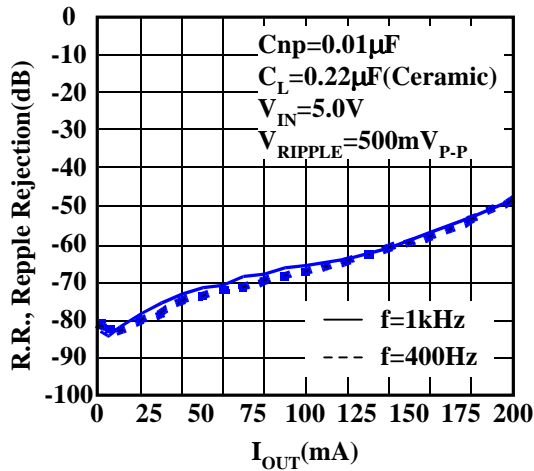

■ Ripple Rejection

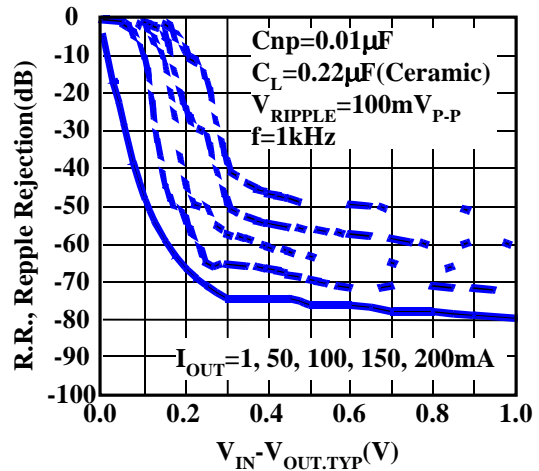

11-4. On/off control transient response

- Parameter: $C_L=0.22\mu\text{F}, 2.2\mu\text{F}, 10\mu\text{F}$
- Fixed: $C_{np}=0.001\mu\text{F}$

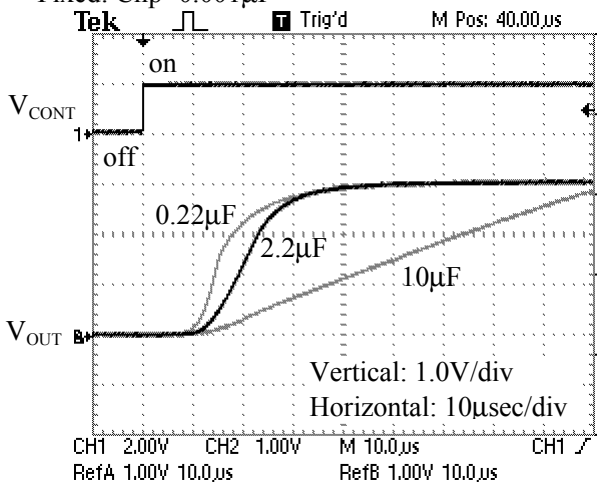

Common conditions are shown as follows:

- $V_{CONT}=0\text{V} \leftrightarrow 2.0\text{V}$ @ $f=100\text{Hz}$
- $I_{OUT}=30\text{mA}$
- $C_{IN}=1.0\mu\text{F}$
- $C_L=2.2\mu\text{F}$
- $C_{np}=0.001\mu\text{F}$

Parameter: $C_{np}=100\text{pF}, 0.001\mu\text{F}, 0.01\mu\text{F}$
 Fixed: $C_L=2.2\mu\text{F}$

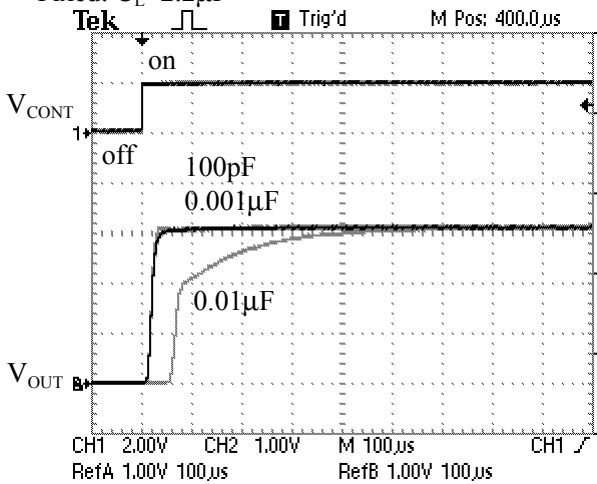

Parameter: $C_{np}=0.001\mu\text{F}, 0.01\mu\text{F}, 0.1\mu\text{F}$
 Fixed: $C_L=2.2\mu\text{F}$

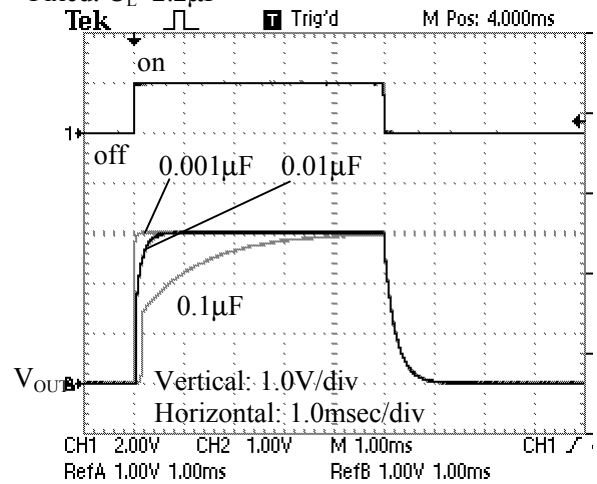

11-5. Load transient

$I_{OUT}=5\text{mA} \leftarrow \rightarrow 35\text{mA}$

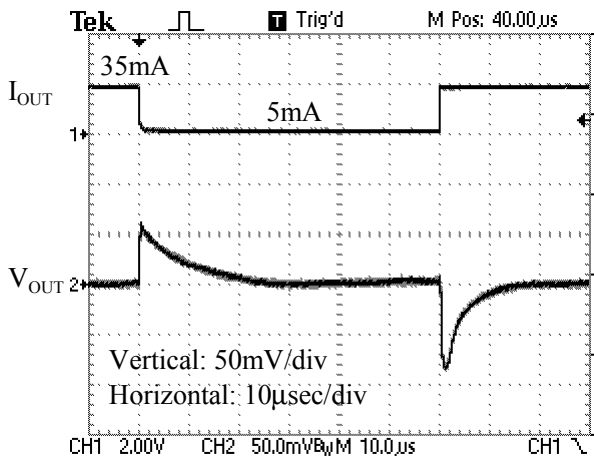

Common conditions are shown as follows:

- $V_{CONT}=2.0\text{V}$
- $C_{IN}=1.0\mu\text{F}$
- $C_L=2.2\mu\text{F}$
- $C_{np}=0.001\mu\text{F}$

Parameter: $C_L=0.22\mu\text{F}, 2.2\mu\text{F}, 10\mu\text{F}$
 Fixed: $C_{np}=0.001\mu\text{F}$

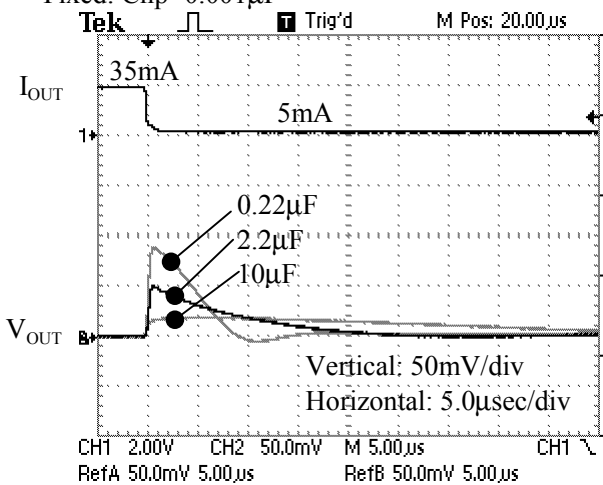

Parameter: $C_L=0.22\mu\text{F}, 2.2\mu\text{F}, 10\mu\text{F}$
 Fixed: $C_{np}=0.001\mu\text{F}$

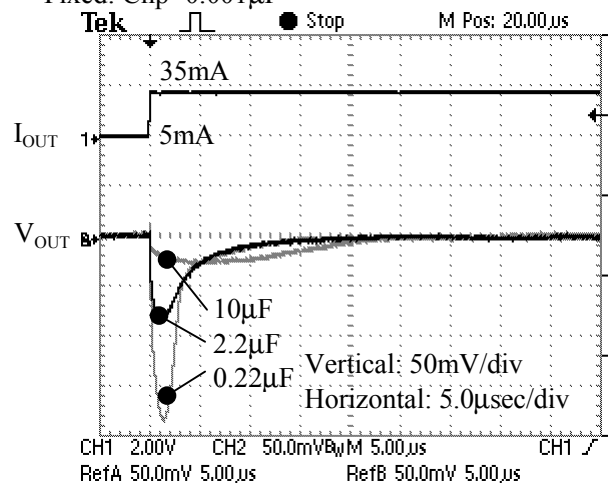

■ $I_{OUT}=30mA \rightarrow 0mA, 35mA \rightarrow 5mA$

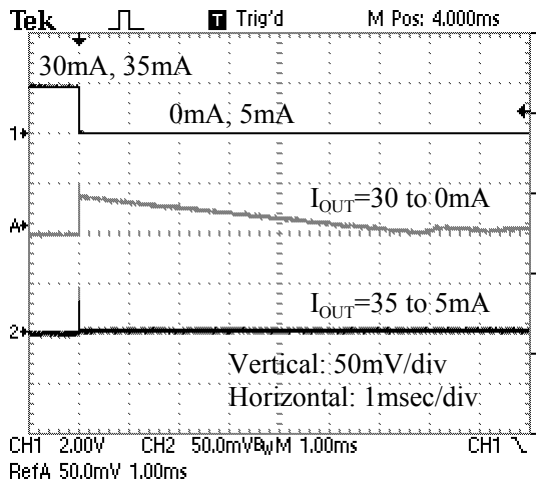

■ $I_{OUT}=0mA \rightarrow 30mA, 5mA \rightarrow 35mA$

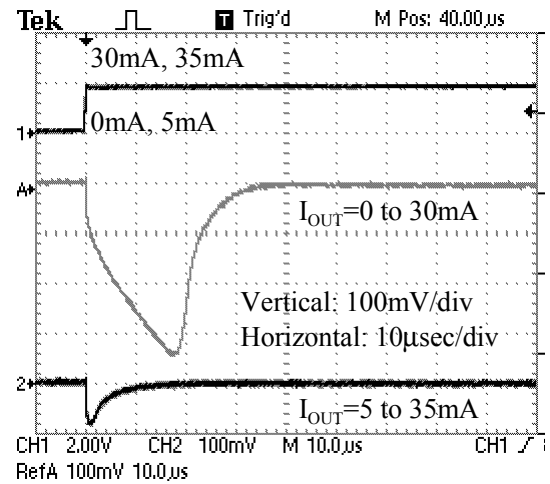

11-6. Line transient

■ $V_{IN}=V_{OUT,TYP}+1.0V \leftrightarrow +2.0V$
 ($I_{OUT}=30mA, V_{CONT}=1.8V, C_{IN}=1.0µF, C_L=2.2µF, C_{np}=0.001µF$)

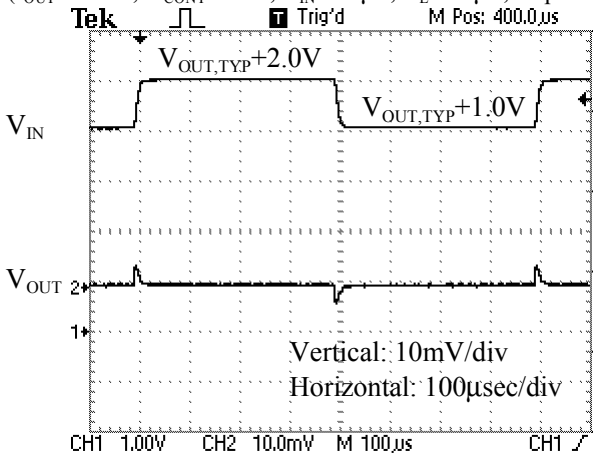

■ $C_L=0.22µF, 2.2µF, 10µF$
 $C_{np}=0.001µF$

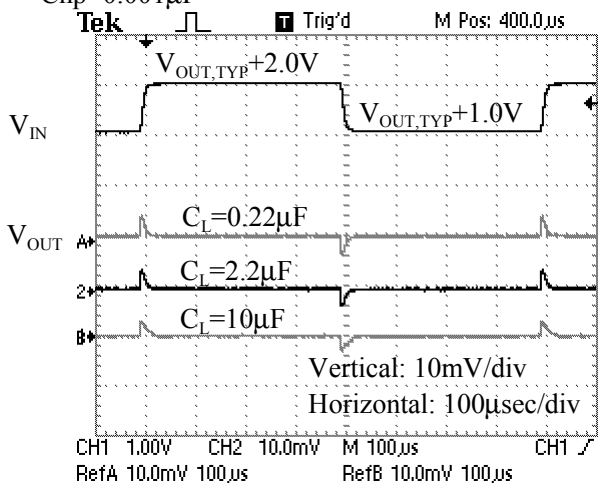

- Cnp=0.001μF, 0.01μF, 0.1μF
CL=2.2μF

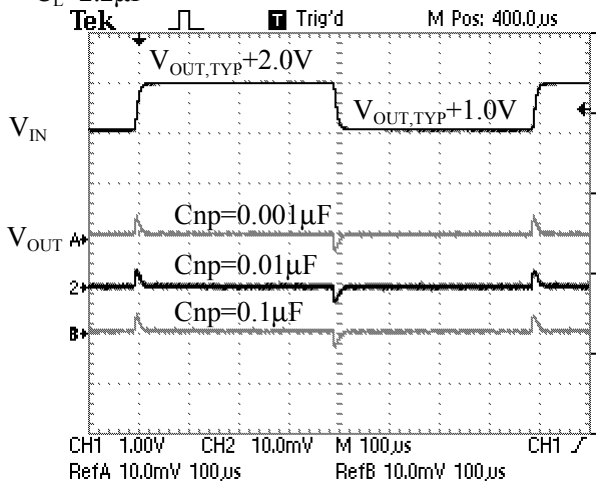

11-7. Output noise

TK11130CS BPF=400Hz~80kHz

- Noise verse Noise Pass Capacitance
Iout=30mA

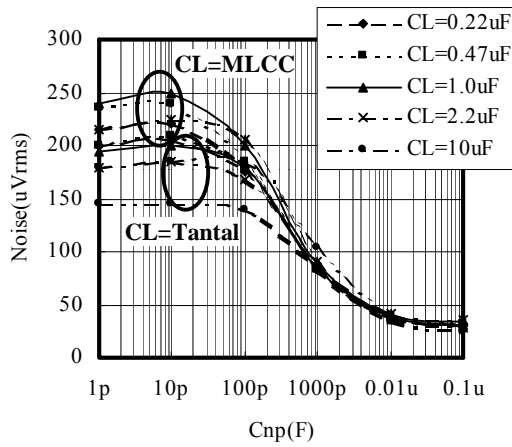

- Noise versus Output Voltage
Iout=30mA, Cnp=0.01μF, CL=1.0μF(Tantal)

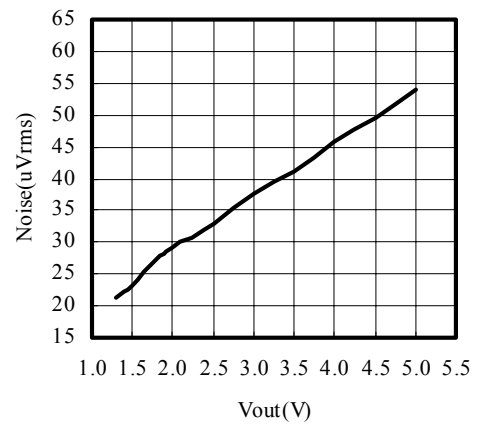

- Noise versus Output Current
CL=Tantal, Cnp=0.01μF

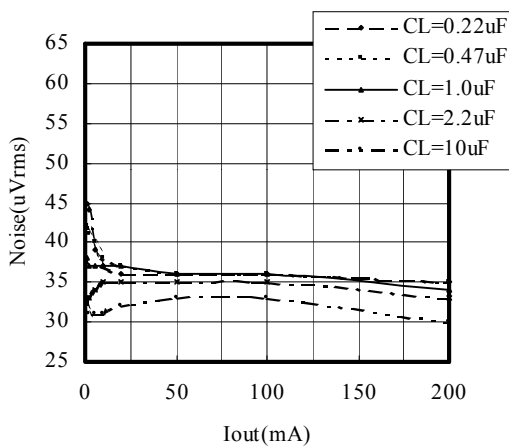

- Noise versus Output Current
CL=MLCC, Cnp=0.01μF

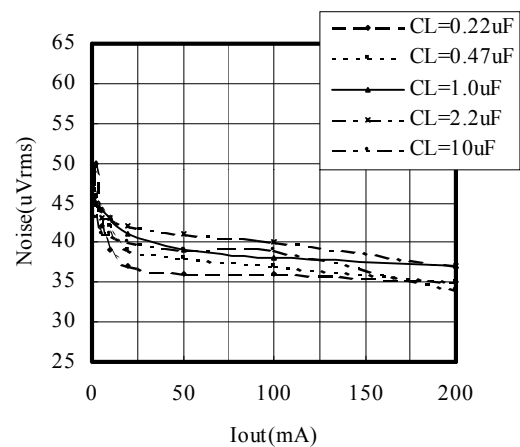

■ Noise verse Frequency

$I_{out}=10mA$, $C_{in}=10\mu F$, $C_L=0.22\mu F(MLCC)$

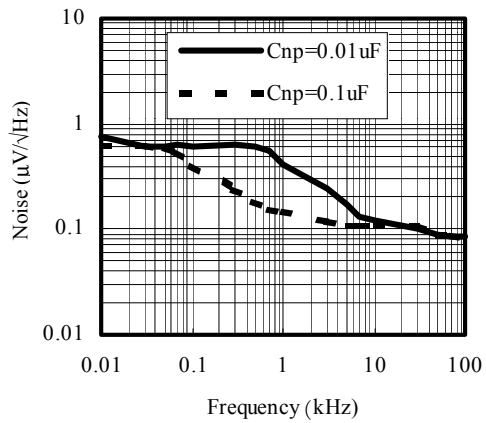

CL is not increased and it is more effective in the noise decrease to enlarge Cnp. The Cnp capacity recommends 6800pF(682) or 0.01µF(103). The amount of the noise increases in a higher output voltage.

Please increase this capacity when low noise or more is demanded. IC does not operate abnormally about 0.1 and 0.22µF.

MLCC stance for Multi Layer Ceramic Capacitor.

TANTAL Stance for Tantalum Capacitor.

12. PIN DESCRIPTION

Pin No.	Pin Description	Internal Equivalent Circuit	Description
1	V_{CONT}		<p>On/Off Control Terminal</p> <p>C Rank $V_{CONT} > 1.6V$: ON $V_{CONT} < 0.6V$: OFF</p> <p>I Rank $V_{CONT} > 1.8V$: ON $V_{CONT} < 0.35V$: OFF</p> <p>The pull-down resistor (500kΩ) is built-in.</p>
2	GND		GND Terminal
3	NP		<p>Noise Bypass Terminal</p> <p>Connect a bypass capacitor between GND.</p>
4	V_{OUT}		Output Terminal
5	V_{IN}		Input Terminal

13. APPLICATIONS INFORMATION

13-1. Input / output capacitors

Linear regulators require input and output capacitors in order to maintain the regulator's loop stability. The equivalent series resistance (ESR) of the output capacitor must be in the stable operation area. However, it is recommended to use as large a value of capacitance as is practical. The output noise and the ripple noise decrease as the capacitance value increases.

ESR values vary widely between ceramic and tantalum capacitors. However, tantalum capacitors are assumed to provide more ESR damping resistance, which provides greater circuit stability. This implies that a higher level of circuit stability can be obtained by using tantalum capacitors when compared to ceramic capacitors with similar values.

For output voltage device $\geq 2.0V$ applications, the recommended value of $C_L \geq 0.10\mu F$.
 For output voltage device $\geq 1.5V$ applications, the recommended value of $C_L \geq 0.22\mu F$

The input capacitor is necessary when the battery is discharged, the power supply impedance increases, or the line distance to the power supply is long. This capacitor might be necessary on each individual IC even if two or more regulator ICs are used. It is not possible to determine this indiscriminately. Please confirm the stability while mounted.

The IC provides stable operation with an output side capacitor of

$0.1\mu F$ ($V_{out} \geq 2.0V$). If it is $0.1\mu F$ or more over the full range of temperature, either a ceramic capacitor or tantalum capacitor can be used without considering ESR.

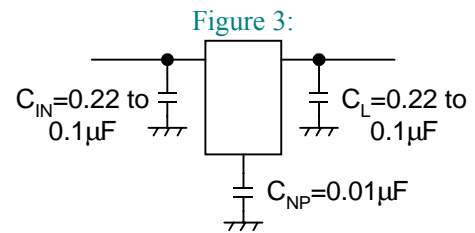
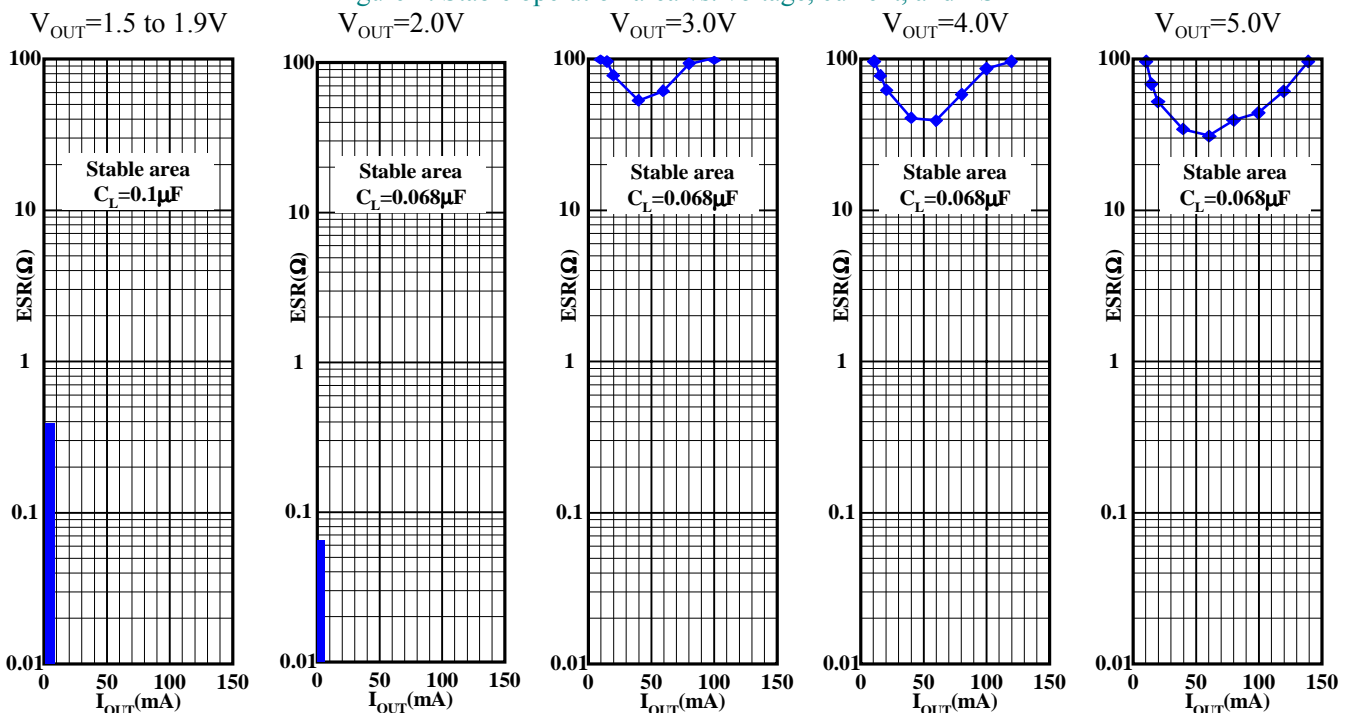

Figure 4: Stable operation area vs. voltage, current, and ESR



All stable: $C_L \geq 0.22\mu F$ All stable: $C_L \geq 0.1\mu F$

Please increase the output capacitor value when the load current is 0.5 mA or less. The stability of the regulator improves if a big output side capacitor is used (the stable operation area extends.)

Bias voltage and temperature characteristics of the ceramic capacitor

Generally, a ceramic capacitor has both a temperature characteristic and a voltage characteristic. Please consider both characteristics when selecting the part. The B curves are the recommend characteristics.

■ Capacitance versus Voltage

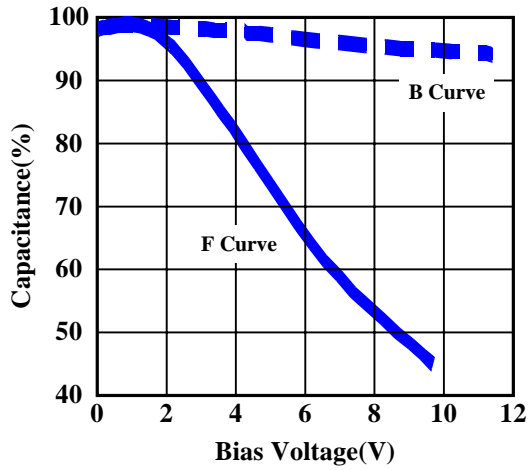

■ Capacitance versus Ambient Temperature

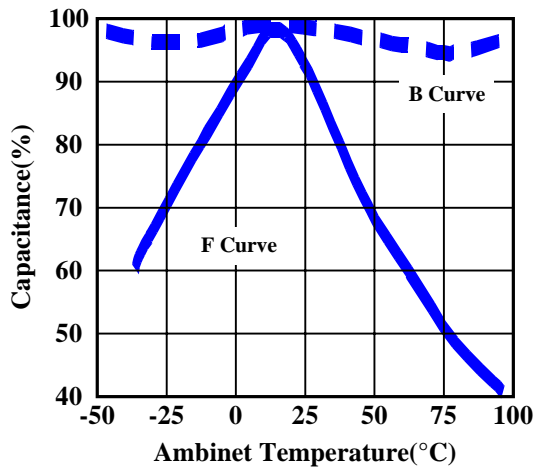

13-2. Definition of term

◆ **Output Voltage (Vout)**

The output voltage is specified with $V_{in}=(V_{out_{TYP}}+1V)$ and $I_{out}=5mA$.

◆ **Maximum Output Current (Iout MAX)**

The rated output current is specified under the condition where the output voltage drops 0.3V the value specified with $I_{out}=5mA$. The input voltage is set to $V_{out_{TYP}}+1V$ and the current is pulsed to minimize temperature effect.

◆ **Dropout Voltage (Vdrop)**

The dropout voltage is the difference between the input voltage and the output voltage at which point the regulator starts to fall out of regulation. Below this value, the output voltage will fall as the input voltage is reduced. It is dependent upon the load current and the junction temperature.

◆ **Line Regulation (LinReg)**

Line regulation is the ability of the regulator to maintain a constant output voltage as the input voltage changes. The line regulation is specified as the input voltage is changed from $V_{in}=V_{out_{TYP}}+1V$ to $V_{in}=V_{out_{TYP}}+6V$. It is a pulse measurement to minimize temperature effect.

◆ **Load Regulation (LoaReg)**

Load regulation is the ability of the regulator to maintain a constant output voltage as the load current changes. It is a pulsed measurement to minimize temperature effects with the input voltage set to $V_{in}=V_{out_{TYP}}+1V$. The load regulation is specified output current step conditions of 5mA to 100mA.

◆ **Ripple Rejection (R.R)**

Ripple rejection is the ability of the regulator to attenuate the ripple content of the input voltage at the output. It is specified with $200mV_{rms}$, 1kHz super-imposed on the input voltage, where $V_{in}=V_{out}+1.5V$. Ripple rejection is the ratio of the ripple content of the output vs. input and is expressed in dB.

◆ **Standby Current (Istandby)**

Standby current is the current, which flows into the regulator when the output is turned off by the control function ($V_{cont}=0V$).

◆ **Over Current Sensor**

The over current sensor protects the device when there is excessive output current. It also protects the device if the output is accidentally connected to ground.

◆ **Thermal Sensor**

The thermal sensor protects the device in case the junction temperature exceeds the safe value ($T_j=150^{\circ}C$). This temperature rise can be caused by external heat, excessive power dissipation caused by large input to output voltage drops, or excessive output current. The regulator will shut off when the temperature exceeds the safe value. As the junction temperatures decrease, the regulator will begin to operate again. Under sustained fault conditions, the regulator output will oscillate as the device turns off then resets. Damage may occur to the device under extreme fault.

Please reduce the loss of the regulator when this protection operate, by reducing the input voltage or make better heat efficiency.

* In the case that the power, $V_{in} \times I_{short}$ (Short Circuit Current), becomes more than twice of the maximum rating of its power dissipation in a moment, there is a possibility that the IC is destroyed before internal thermal protection works.

◆ **Reverse Voltage Protection**

Reverse voltage protection prevents damage due to the output voltage being higher than the input voltage. This fault condition can occur when the output capacitor remains charged and the input is reduced to zero, or when an external voltage higher than the input voltage is applied to the output side

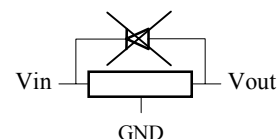

◆ **ESD**

MM: 200pF 0Ω 200V or more

HBM: 100pF 1.5kΩ 2000V or more

13-3. Board Layout

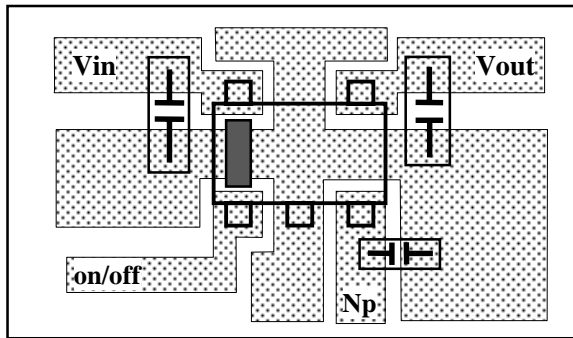

PCB Material: Glass epoxy (t=0.8mm)

Please do derating with 4.0mW/°C at Pd=500mW and 25°C or more. Thermal resistance (θja) is=250°C/W.

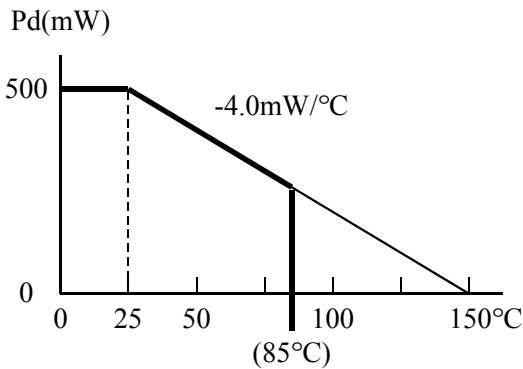

The package loss is limited at the temperature that the internal temperature sensor works (about 150°C). Therefore, the package loss is assumed to be an internal limitation. There is no heat radiation characteristic of the package unit assumed because of the small size. The device being mounted on the PCB carries heat away. This value changes by the material and the copper pattern etc. of the PCB. The losses are approximately 500mW. Enduring these losses becomes possible in a lot of applications operating at 25°C.

The overheating protection circuit operates when there are a lot of losses with the regulator (When outside temperature is high or heat radiation is bad). The output current cannot be pulled enough and the output voltage will drop when the protection circuit operates. When the junction temperature reaches 150°C, the IC is shut down. However, operation begins at once when the IC stops operation and the temperature of the chip decreases.

How to determine the thermal resistance when mounted on PCB

The thermal resistance when mounted is expressed as follows:

$$T_j = \theta_{ja} \times P_d + T_a$$

Tj of IC is set around 150°C. Pd is the value when the thermal sensor is activated.

If the ambient temperature is 25°C, then:

$$150 = \theta_{ja} \times P_d + 25$$

$$\theta_{ja} = 125 / P_d \text{ (}^\circ\text{C / mW)}$$

The simple method to calculate Pd

Mount the IC on the print circuit board. Short between the output pin and ground. after that, raise input voltage from 0V to evaluated voltage (see*1) gradually.

At shorted the output pin, the power dissipation Pd can be expressed as Pd=Vin × Iin.

The input current decreases gradually as the temperature of the chip becomes high. After a while, it reaches the thermal equilibrium. Use this current value at the thermal equilibrium. In almost all the cases, it shows 500mW or more.

*1 In the case that the power, Vin × Ishort(Short Circuit Current), becomes more than twice of the maximum rating of its power dissipation in a moment, there is a possibility that the IC is destroyed before internal thermal protection works.

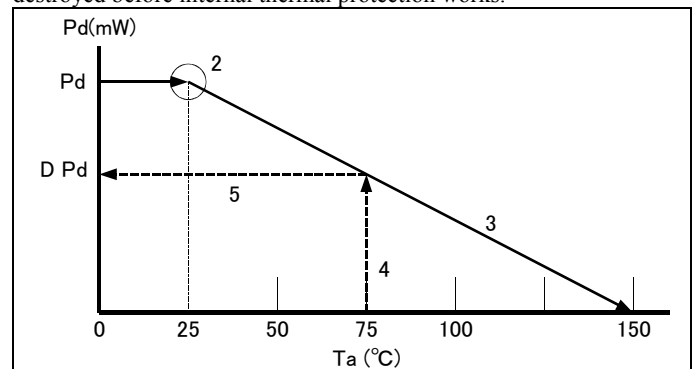

Procedure (When mounted on PCB.)

1. Find Pd (Vin×Iin when the output side is short-circuited).
2. Plot Pd against 25°C.
3. Connect Pd to the point corresponding to the 150°C with a straight line.
4. In design, take a vertical line from the maximum operating temperature (e.g., 75°C) to the derating curve.
5. Read off the value of Pd against the point at which the vertical line intersects the derating curve. This is taken as the maximum power dissipation DPd.
6. DPd ÷ (Vinmax-Vout)=Iout (at 75°C)

The maximum output current at the highest operating temperature will be **Iout ≅ DPd ÷ (VinMax-Vout)**.

Please use the device at low temperature with better radiation. The lower temperature provides better quality.

13-4. On/off control

It is recommended to turn the regulator off when the circuit following the regulator is non-operating. A design with little electric power loss can be implemented. We recommend the use of the on/off control of the regulator without using a high side switch to provide an output from the regulator. A highly accurate output voltage with low voltage drop is obtained.

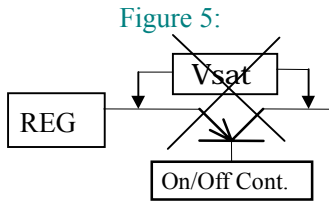

Because the control current is small, it is possible to control it directly by CMOS logic.

Parallel-Connected ON/OFF Control

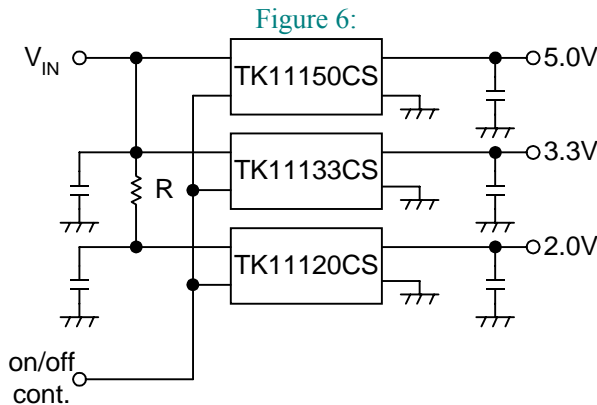

The above figure is multiple regulators being controlled by a single On/Off control signal. There is fear of overheating, because the power loss of the low voltage side IC (TK11120CS) is large. The series resistor (R) is put in the input line of the low output voltage regulator in order to prevent over-dissipation. The voltage dropped across the resistor reduces the large input-to-output voltage across the regulator, reducing the power dissipation in the device. When the thermal sensor works, a decrease of the output voltage, oscillation, etc. may be observed.

13-5. Noise Bypass

The noise and the ripple rejection characteristics depend on the capacitance on the Np terminal.

The ripple rejection characteristic of the low frequency region improves by increasing the capacitance of Cnp.

A standard value is Cnp=0.001μF. Increase Cnp in a design with important output noise and ripple rejection requirements. The IC will not be damaged if the capacitor value is increased.

The on/off switching speed changes depending on the Np terminal capacitance. The switching speed slows when the capacitance is large.

13-6. Current boost

Please use the undermentioned product. The low saturation and the large current regulator can be easily made.

TK714xx: Only PNP-Tr for a current boost is external.

* Built-in short circuit protection: constant current can be set by external resistor.

13-7. Outline; PCB; Stamps

SOT23-5

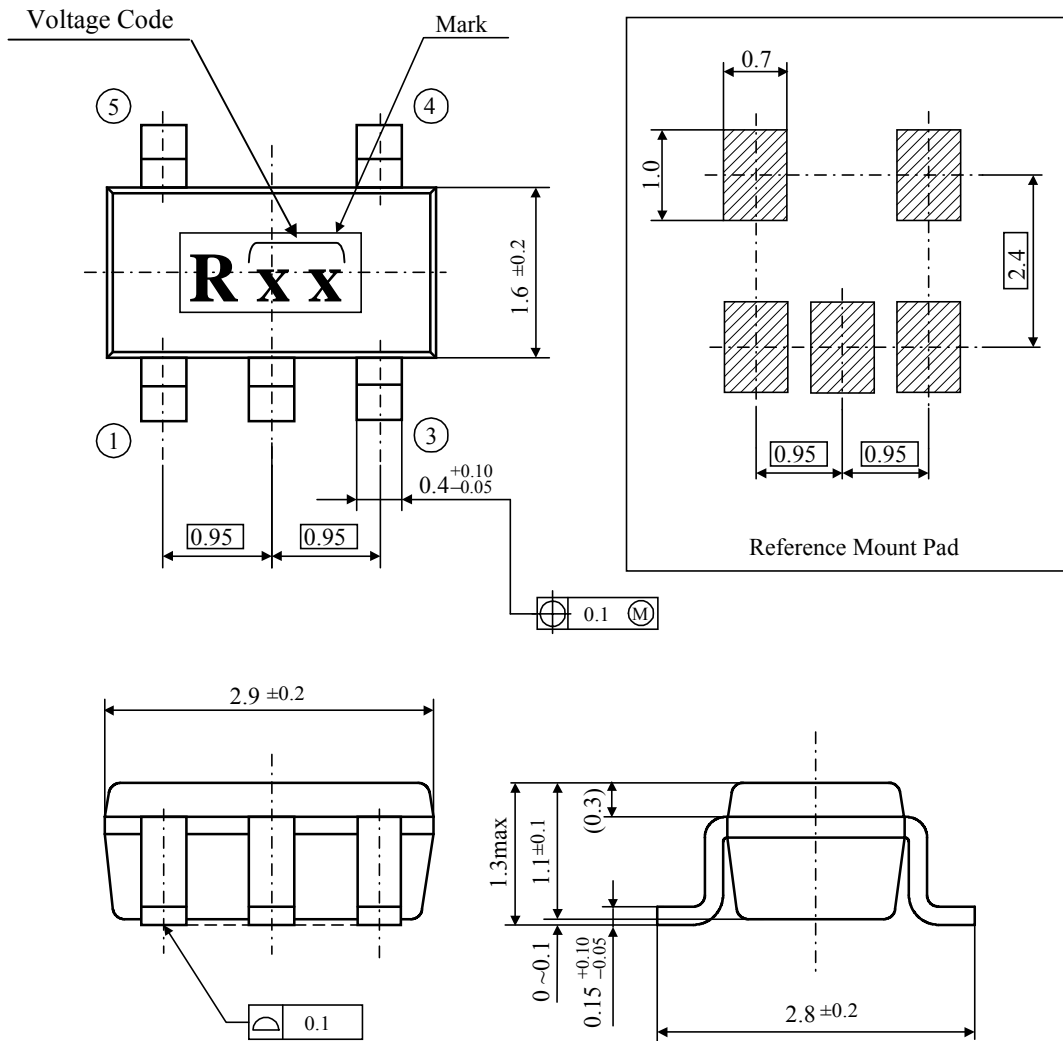

Unit: mm

Package Structure

Package Material: Epoxy Resin
 Terminal Material: Copper Alloy
 Mass (Reference): 0.016g

V OUT	V CODE	V OUT	V CODE	V OUT	V CODE	V OUT	V CODE
1.5V	15	2.4V	24	3.3V	33	4.2V	42
1.6	16	2.5	25	3.4	34	4.3	43
1.7	17	2.6	26	3.5	35	4.4	44
1.8	18	2.7	27	3.6	36	4.5	45
1.9	19	2.8	28	3.7	37	4.6	46
2.0	20	2.9	29	3.8	38	4.7	47
2.1	21	3.0	30	3.9	39	4.8	48
2.2	22	3.1	31	4.0	40	4.9	49
2.3	23	3.2	32	4.1	41	5.0	50

The output voltage table indicates the standard value when manufactured.
 Please contact your authorized Toko representative for voltage availability.

14. NOTES

- Please be sure that you carefully discuss your planned purchase with our office if you intend to use the products in this application manual under conditions where particularly extreme standards of reliability are required, or if you intend to use products for applications other than those listed in this application manual.
 - Power drive products for automobile, ship or aircraft transport systems; steering and navigation systems, emergency signal communications systems, and any system other than those mentioned above which include electronic sensors, measuring, or display devices, and which could cause major damage to life, limb or property if misused or failure to function.
 - Medical devices for measuring blood pressure, pulse, etc., treatment units such as coronary pacemakers and heat treatment units, and devices such as artificial organs and artificial limb systems which augment physiological functions.
 - Electrical instruments, equipment or systems used in disaster or crime prevention.

- Semiconductors, by nature, may fail or malfunction in spite of our devotion to improve product quality and reliability. We urge you to take every possible precaution against physical injuries, fire or other damages which may cause failure of our semiconductor products by taking appropriate measures, including a reasonable safety margin, malfunction preventive practices and fire-proofing when designing your products.

- This application manual is effective from Dec 2004. Note that the contents are subject to change or discontinuation without notice. When placing orders, please confirm specifications and delivery condition in writing.

- TOKO is not responsible for any problems nor for any infringement of third party patents or any other intellectual property rights that may arise from the use or method of use of the products listed in this application manual. Moreover, this application manual does not signify that TOKO agrees implicitly or explicitly to license any patent rights or other intellectual property rights which it holds.

- None of the ozone depleting substances(ODS) under the Montreal Protocol are used in our manufacturing process.

15. OFFICES

- If you need more information on this product and other TOKO products, please contact us.
- TOKO Inc. Headquarters
 1-17, Higashi-yukigaya 2-chome, Ohta-ku, Tokyo, 145-8585, Japan
 TEL: +81.3.3727.1161
 FAX: +81.3.3727.1176 or +81.3.3727.1169
 Web site: <http://www.toko.co.jp/>

 - TOKO America
 Web site: <http://www.toko.com/>

 - TOKO Europe
 Web site: <http://www.tokoeurope.com/>

 - TOKO Hong Kong
 Web site: <http://www.toko.com.hk/>

 - TOKO Taiwan
 Web site: <http://www.tokohc.com.tw/>

 - TOKO Singapore
 Web site: <http://www.toko.com.sg/>

 - TOKO Seoul
 Web site: <http://www.toko.co.kr/>

 - TOKO Manila
 Web site: <http://www.toko.com.ph/>

 - TOKO Brazil
 Web site: <http://www.toko.com.br/>



Semiconductor Division

YOUR DISTRIBUTOR