

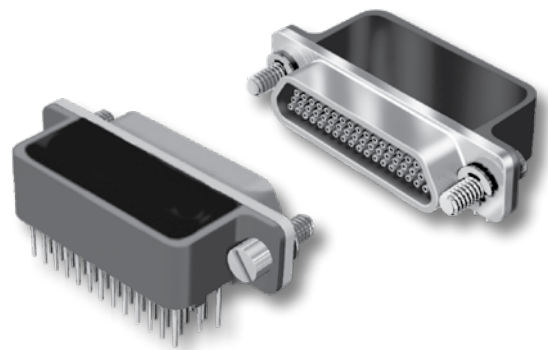

# GMR7590C Right Angle Mount Micro-D Connectors Compact Flange



**Innovative Design for Flex Circuits** – These Micro-D connectors answer the need for a compact flex circuit connector. Featuring .075 X .075 inch row spacing. Glenair's GMR7590C accepts standard jackscrews and jackposts, making it ideal for flex-to-board applications.

**High Performance** – Approved for British Standard BS9000, GMR7590C connectors meet the performance requirements of MIL-DTL-83513. Gold plated TwistPin contacts assure best electrical and mechanical performance.

## HOW TO ORDER GMR7590 RIGHT ANGLE .075" PITCH PCB CONNECTORS

Series	Number of Contacts	Contact Type	Tail Length In. (mm.)	Shell Plating Finish	Hardware	Gold-Plated Terminal Mod Code
<b>GMR7590C</b> Micro-D Metal Shell, Right Angle Mount PCB, Compact	9	<b>P</b> Pin	1 – .109" (2.76)	<b>A</b> – Cadmium <b>B</b> – Nickel <b>C</b> – Alchrome <b>D</b> – Black Anodize <b>E</b> – Gold	<b>B</b> <b>P</b> <b>M</b> <b>M1</b> <b>S</b> <b>S1</b> <b>L</b> <b>K</b> <b>F</b> <b>R</b>	These connectors are solder-dipped in 63/37 tin-lead solder.  <b>To delete the solder dip and change to gold-plated terminals, add code 513</b>
	15		2 – .150" (3.81)			
	21		3 – .190" (4.83)			
	25	<b>S</b> Socket	4 – .250" (6.35)			
	31		5 – Staggered Tail Length			
	37					
	51					
100						
<b>Sample Part Number</b>						
<b>GMR7590C</b>	<b>– 31</b>	<b>S</b>	<b>2</b>	<b>B</b>	<b>S1</b>	

## MICRO-D MOUNTING HARDWARE

B	P	M	M1	S	S1	L	K	F	R
<b>Thru-Hole</b> Order Hardware Separately	<b>Jackpost</b> Removable Includes Nut and Washer	<b>Jackscrew</b> Hex Head Removable E-ring	<b>Jackscrew</b> Hex Head Removable E-ring Extended	<b>Jackscrew</b> Slot Head Removable E-ring	<b>Jackscrew</b> Slot Head Removable E-ring Extended	<b>Jackscrew</b> Hex Head Non-Removable	<b>Jackscrew</b> Slot Head Non-Removable Extended	<b>Float Mount</b> For Front Panel Mounting	<b>Float Mount</b> For Rear Panel Mounting

# GMR7590C Right Angle Mount Micro-D Connectors Compact Flange



Micro-D  
PCB

## PERFORMANCE SPECIFICATIONS

Current Rating	3 AMP
DWV	600 VAC Sea level
Insulation Resistance	5000 Megohms Minimum
Contact Resistance	8 Milliohms Maximum
Low Level Contact Resist.	32 Milliohms Maximum
Magnetic Permeability	2 $\mu$ Maximum
Operating Temperature	-55° C. to +150° C.
Shock, Vibration	50 g., 20g.
Mating Force	(10 Ounces) X (# of Contacts)

## MATERIALS AND FINISHES

Connector Shell	Aluminum Alloy 6061 or Stainless Steel, 300 Series, passivated. See Ordering Info for Plating Options
Insulator, Tray	Liquid Crystal Polymer (LCP)
Interfacial Seal	Flourosilicone Rubber, Blue
Pin Contact	Beryllium Copper Gold over Nickel Plating
Socket Contact	Copper Alloy Gold Over Nickel Plating
PCB Terminals	Gold Plated Copper Alloy, Solder Dipped
Hardware	300 Series Stainless Steel
Encapsulant	Epoxy Resin Hysol EE4215

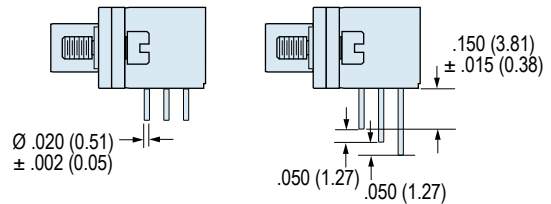
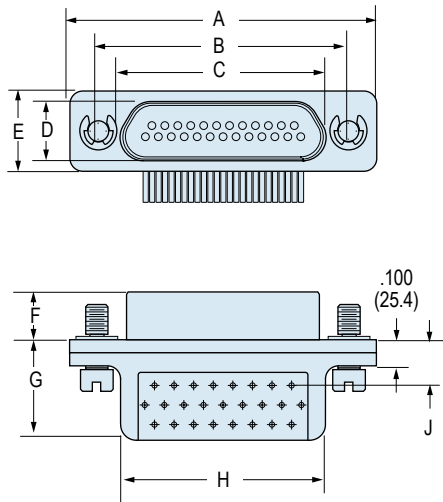

STAGGERED LEADS

SIZES 9 THRU 51 MOUNTING HOLE IS .088/.094 (2.24/2.39)  
SIZE 100 MOUNTING HOLE IS .145/.150 (3.68/3.81)

SIZES 9 THRU 51 THREAD SIZE IS #2-56 UNC  
SIZE 100 THREAD SIZE IS #4-40

## GMR7590C CONNECTOR DIMENSIONS

Layout	A Max.		B		C Max.		D Max.		E Max.		F		G Max.		H	
	In.	mm.	In. ±.005	mm. ±0.13	In.	mm.	In.	mm.	In.	mm.	In. ±.003	mm. ±0.08	In.	mm.	In. ±.010	mm. ±0.25
<b>9P</b>	.785	19.94	.565	14.35	.335	8.51	.185	4.70	.310	7.87	.183	4.65	.400	10.16	.400	10.16
<b>9S</b>	.785	19.94	.565	14.35	.400	10.16	.251	6.38	.310	7.87	.195	4.95	.400	10.16	.400	10.16
<b>15P</b>	.935	23.75	.715	18.16	.485	12.32	.185	4.70	.310	7.87	.183	4.65	.400	10.16	.550	13.97
<b>15S</b>	.935	23.75	.715	18.16	.550	13.97	.251	6.38	.310	7.87	.195	4.95	.400	10.16	.550	13.97
<b>21P</b>	1.085	27.56	.865	21.97	.635	16.13	.185	4.70	.310	7.87	.183	4.65	.400	10.16	.700	17.78
<b>21S</b>	1.085	27.56	.865	21.97	.700	17.78	.251	6.38	.310	7.87	.195	4.95	.400	10.16	.700	17.78
<b>25P</b>	1.185	30.01	.965	24.51	.735	18.67	.185	4.70	.310	7.87	.183	4.65	.400	10.16	.800	20.32
<b>25S</b>	1.185	30.01	.965	24.51	.800	20.32	.251	6.38	.310	7.87	.195	4.95	.400	10.16	.800	20.32
<b>31P</b>	1.335	33.91	1.115	28.32	.885	22.48	.185	4.70	.310	7.87	.183	4.65	.400	10.16	.950	24.13
<b>31S</b>	1.335	33.91	1.115	28.32	.950	24.13	.251	6.38	.310	7.87	.195	4.95	.400	10.16	.950	24.13
<b>37P</b>	1.485	37.72	1.265	32.13	1.035	26.29	.185	4.70	.310	7.87	.183	4.65	.400	10.16	1.100	27.94
<b>37S</b>	1.485	37.72	1.265	32.13	1.100	27.94	.251	6.38	.310	7.87	.195	4.95	.400	10.16	1.100	27.94
<b>51P</b>	1.435	36.45	1.215	30.86	.985	25.02	.228	5.79	.351	8.92	.183	4.65	.490	12.45	1.050	26.67
<b>51S</b>	1.435	36.45	1.215	30.86	1.050	26.67	.294	7.47	.351	8.92	.195	4.95	.490	12.45	1.050	26.67
<b>100P</b>	2.170	55.12	1.800	45.72	1.384	35.15	.271	6.88	.394	10.00	.183	4.65	.660	16.76	1.500	38.13
<b>100S</b>	2.170	55.12	1.800	45.72	1.508	38.30	.394	10.00	.394	10.00	.195	4.95	.660	16.76	1.500	38.13

## GMR7590C CONNECTOR PCB LAYOUTS – PIN CONNECTORS

Patterns shown are for connector mounting side of PC board.

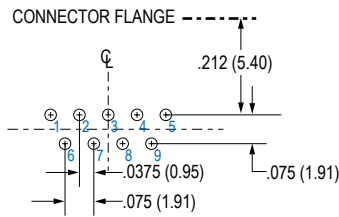

**9 PIN**

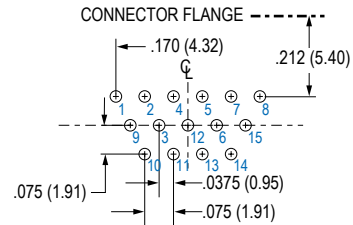

**15 PIN**

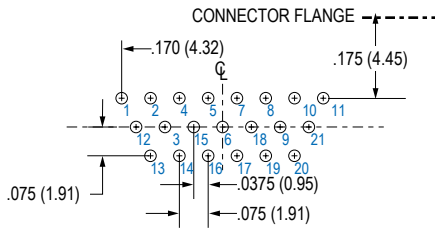

**21 PIN**

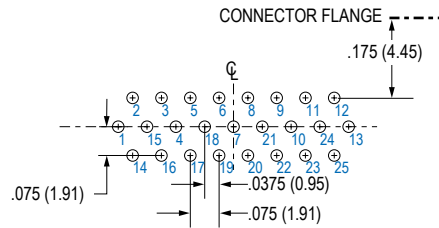

**25 PIN**

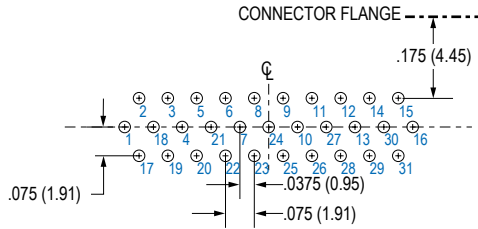

**31 PIN**

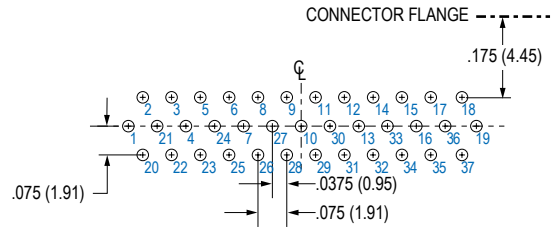

**37 PIN**

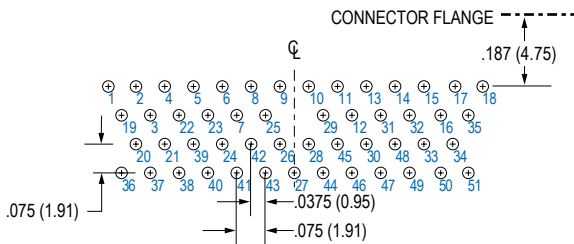

**51 PIN**

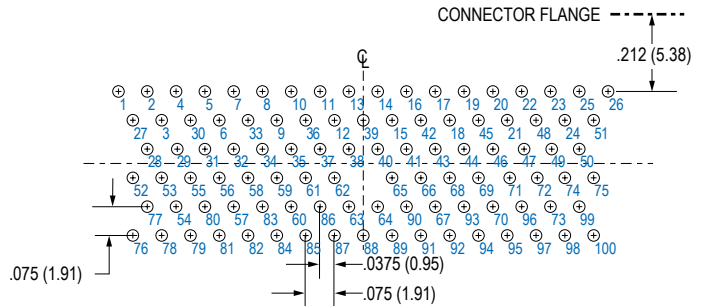

**100 PIN**

## GMR7590C CONNECTOR PCB LAYOUTS – SOCKET CONNECTORS

Patterns shown are for connector mounting side of PC board.

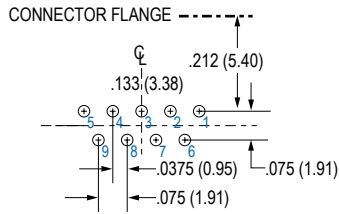

**9 SOCKET**

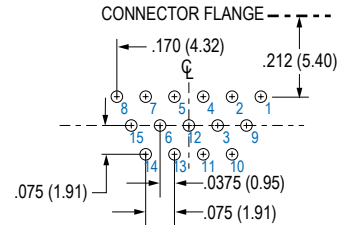

**15 SOCKET**

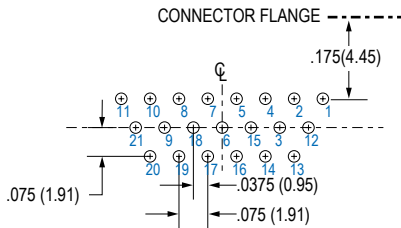

**21 SOCKET**

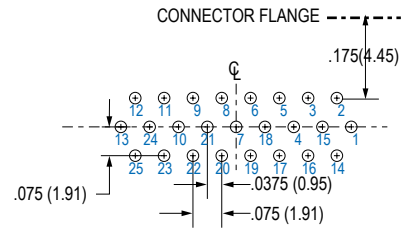

**25 SOCKET**

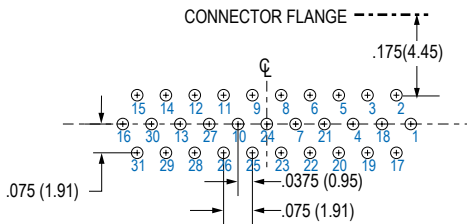

**31 SOCKET**

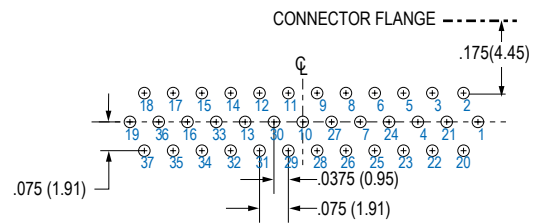

**37 SOCKET**

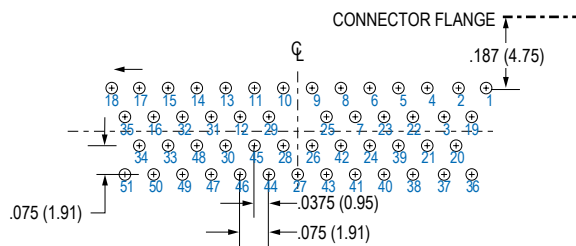

**51 SOCKET**

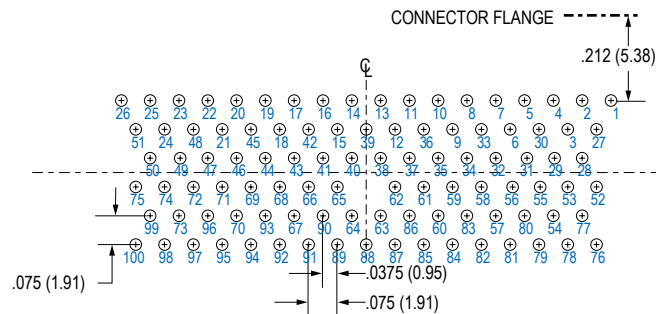

**100 SOCKET**