

### Features

- 1.0W Power Dissipation
- Ideally Suited for Automatic Assembly
- 5.1V - 39V Nominal Zener Voltage Range
- Standard  $V_Z$  Tolerance is  $\pm 5\%$
- Available in Lead Free Finish/RoHS Compliant Version (Note 2)

### Mechanical Data

- Case: SMA
- Case Material: Molded Plastic. UL Flammability Classification Rating 94V-0
- Moisture Sensitivity: Level 1 per J-STD-020C
- Terminals: Solderable per MIL-STD-202, Method 208
- Also Available in Lead Free Plating (Matte Tin Finish). Please see Ordering Information, Note 5, on Page 2
- Marking: Marking & Date Code (See Page 2)
- Ordering Information: See Page 2
- Polarity: Cathode Notch or Cathode Band
- Weight: 0.064 grams (approximate)

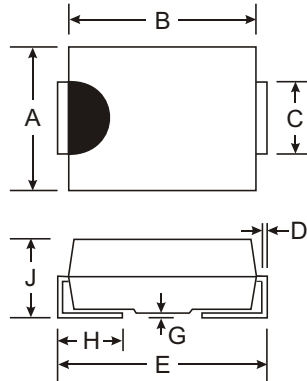

SMA		
Dim	Min	Max
A	2.29	2.92
B	4.00	4.60
C	1.27	1.63
D	0.15	0.31
E	4.80	5.59
G	0.10	0.20
H	0.76	1.52
J	2.01	2.62
All Dimensions in mm		

### Maximum Ratings @ $T_A = 25^\circ\text{C}$ unless otherwise specified

Characteristic	Symbol	Value	Unit
Zener Current (see Table page 2)	$I_{ZM}$	$P_d / V_Z$	mA
Forward Voltage @ $I_F = 200\text{mA}$	$V_F$	1.2	V
Power Dissipation Derate Above $50^\circ\text{C}$ (Note 1) @ $T_A = 50^\circ\text{C}$	$P_d$	1.0 8.0	W mW/ $^\circ\text{C}$
Typical Thermal Resistance - Junction to Terminal (Note 1)	$R_{\theta JT}$	30	$^\circ\text{C/W}$
Typical Thermal Resistance - Junction to Ambient (Note 1)	$R_{\theta JA}$	125	$^\circ\text{C/W}$
Operating and Storage Temperature Range	$T_j, T_{STG}$	-65 to +150	$^\circ\text{C}$

- Notes:
1. Device mounted on FR-4 PCB, 1 inch x 0.85 inch x 0.062 inch; pad layout as shown on Diodes Inc. suggested pad layout document AP02001, which can be found on our website at <http://www.diodes.com/datasheets/ap02001.pdf>.
  2. RoHS revision 13.2.2003. Glass and High Temperature Solder Exemptions Applied, see *EU Directive Annex Notes 5 and 7*.

## Electrical Characteristics @T<sub>A</sub> = 25°C unless otherwise noted

Type Number (Note 4)	Marking Code	Zener Voltage Range (Note 3)			Test Current	Maximum Zener Impedance			Maximum Reverse Current		I <sub>ZM</sub> Max (Note 1)
		V <sub>Z</sub> @ I <sub>ZT</sub>				I <sub>ZT</sub>	Z <sub>ZT</sub> @ I <sub>ZT</sub>	Z <sub>ZK</sub> @ I <sub>ZK</sub>		I <sub>R</sub> @ V <sub>R</sub>	
		Nom (V)	Min (V)	Max (V)	mA	Ω	Ω	mA	μA	V	mA
SMAZ5V1	ZHK	5.1	4.84	5.40	100	5.0	500	1.0	2.5	1.0	196
SMAZ5V6	ZHL	5.60	5.32	5.88	100	2.0	250	2.0	5.0	2.0	179
SMAZ6V2	ZHN	6.20	5.89	6.51	100	2.0	200	2.0	5.0	3.0	161
SMAZ6V8	ZHO	6.80	6.46	7.14	100	2.0	200	1.0	5.0	4.0	147
SMAZ7V5	ZHQ	7.50	7.13	7.88	100	2.0	450	1.0	5.0	5.0	133
SMAZ8V2	ZHR	8.20	7.79	8.61	100	2.0	200	1.0	5.0	6.0	122
SMAZ9V1	ZHT	9.10	8.65	9.56	50	4.0	200	1.0	5.0	7.0	110
SMAZ10	ZHU	10.00	9.50	10.50	50	4.0	200	1.0	1.0	7.6	100
SMAZ12	ZHW	12.00	11.40	12.60	50	7.0	150	1.0	1.0	9.1	83
SMAZ15	ZHZ	15.00	14.25	15.75	50	10	150	1.0	1.0	11.4	67
SMAZ16	ZJA	16.00	15.20	16.80	25	15	150	1.0	0.5	12.2	63
SMAZ18	ZJF	18.00	17.10	18.90	25	15	150	1.0	0.5	13.7	56
SMAZ20	ZJG	20.00	19.00	21.00	25	15	180	1.0	0.5	15.2	50
SMAZ22	ZJK	22.00	20.90	23.10	25	15	180	1.0	0.5	16.7	45
SMAZ24	ZJL	24.00	22.80	25.20	25	15	180	1.0	0.5	18.2	42
SMAZ27	ZJN	27.00	25.65	28.35	25	15	200	1.0	0.5	20.5	37
SMAZ30	ZJQ	30.00	28.50	31.50	25	15	250	1.0	0.5	22.8	33
SMAZ33	ZJR	33.00	31.35	34.65	25	15	300	1.0	0.5	25.1	30
SMAZ36	ZJS	36.00	34.20	37.80	10	40	350	1.0	0.5	27.4	28
SMAZ39	ZJT	39.00	37.05	40.95	10	40	450	1.0	0.5	29.6	26

## Ordering Information (Note 4)

Device*	Packaging	Shipping
SMAZx-13	SMA	5000/Tape & Reel

- Notes:
1. Device mounted on FR-4 PCB, 1 inch x 0.85 inch x 0.062 inch; pad layout as shown on Diodes Inc. suggested pad layout document AP02001, which can be found on our website at <http://www.diodes.com/datasheets/ap02001.pdf>.
  3. Short duration test pulse used to minimize self-heating effect.
  4. For Packaging Details, go to our website at <http://www.diodes.com/datasheets/ap02007.pdf>.
  5. For Lead Free Finish/RoHS Compliant version part number, please add "-F" suffix to the part number above. Example: SMAZx-13-F

\*x = Device Voltage, e.g SMAZ5V1-13.

## Marking Information

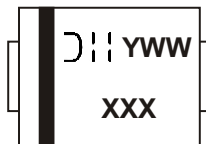

XXX = Product type marking code, ex. ZHK = SMAZ5V1  
 YWW = Date code marking  
 Y = Last digit of year ex: 2 for 2002  
 WW = Week code 01 to 52

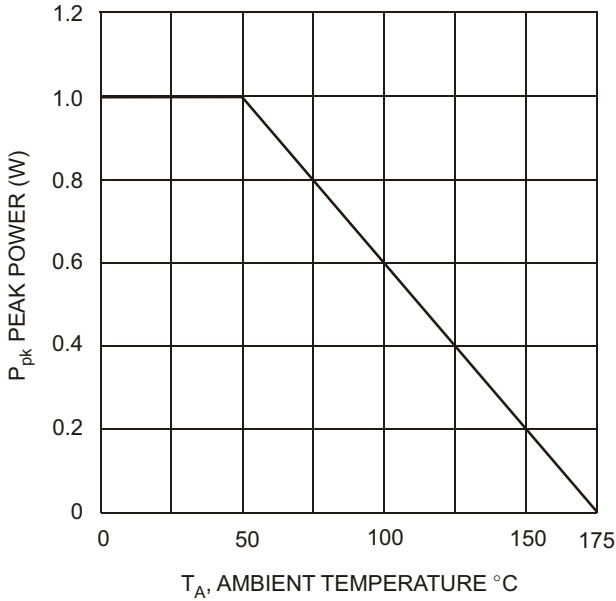

Fig. 1 Power Dissipation vs Ambient Temperature

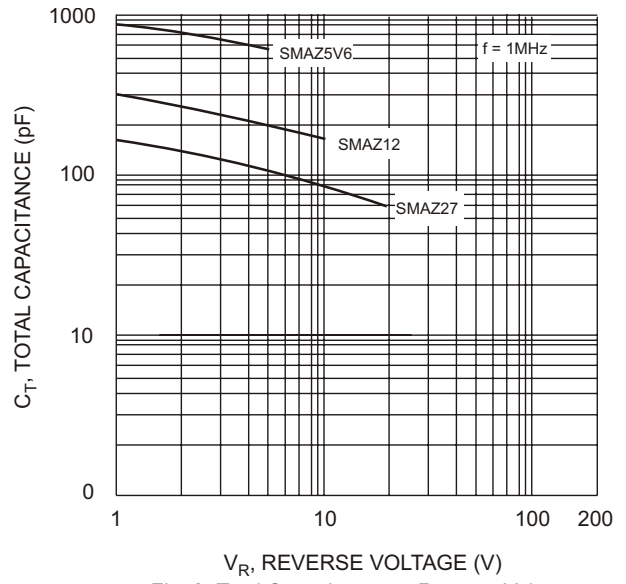

Fig. 2 Total Capacitance vs Reverse Voltage

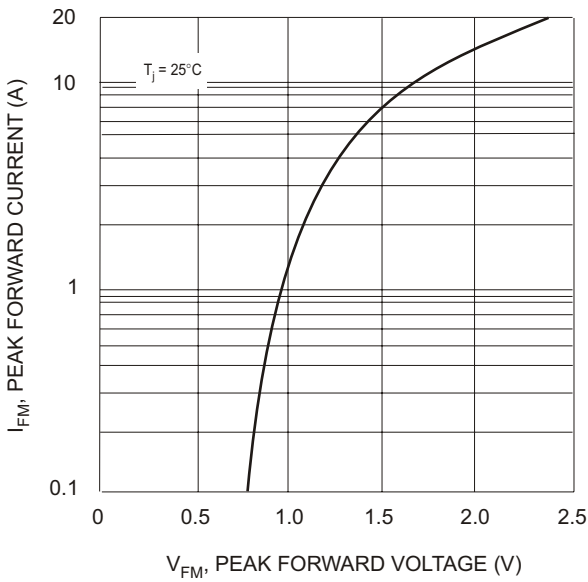

Fig. 3 Peak Forward Current vs Peak Forward Voltage

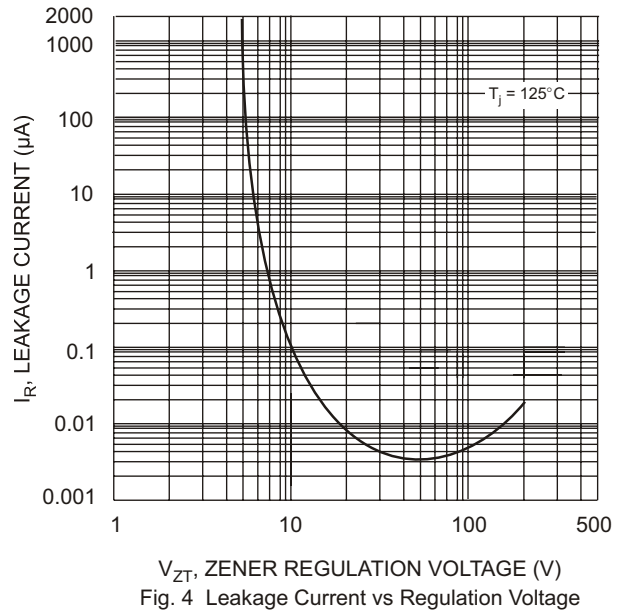

Fig. 4 Leakage Current vs Regulation Voltage

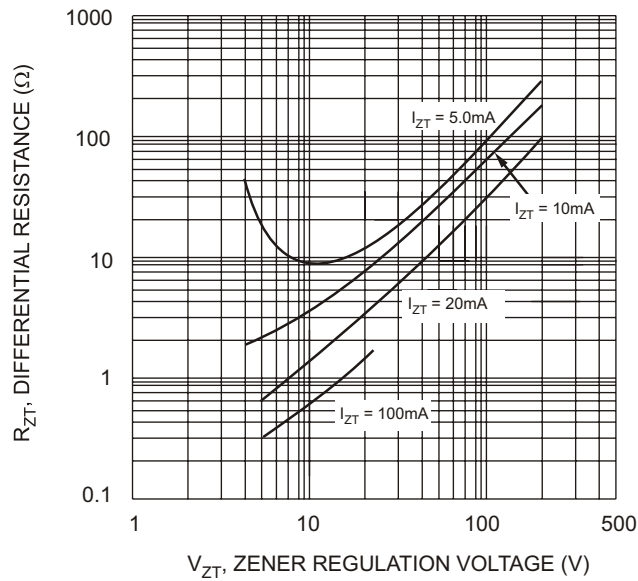

Fig. 5 Differential Resistance vs Regulation Voltage