

**Features**

- RoHS lead-free-solder and lead-solder-exempted products are available.
- Extremely wide input voltage ranges up to 150 VDC
- 4 outputs up to 60 V
- 1200 to 1800 VAC i/o electric strength test
- Electrical isolation also between outputs
- Immunity to IEC/EN 61000-4-2,-3,-4,-5, -6
- Programmable input undervoltage lockout
- Shut down/inhibit input
- Adjustable output voltages with flexible load distribution
- Frequency synchronization
- Outputs no-load, overload, and short-circuit proof
- Operating ambient temperature from -40 to 85 °C
- Thermal protection
- 3"x 2.5" case with 10.5 mm profile or 8.9 mm open frame
- Basic insulation
- Flexible output possibilities between 5 V and 60 V

Safety according to IEC/EN 60950-1 and UL 60950-1



**Description**

The IMX35 Series of board-mountable, 35 Watt DC-DC converters has been designed according to industry requirements and standards. The converters are particularly suitable for use in mobile or stationary applications in transport, railways, industry, or telecommunication, where variable input voltages or high transient voltages are prevalent.

Covering a total input voltage range from 9 V up to 150 V with 4 different models. The units are available with up to quadruple outputs (electrically isolated) from 5 V to 60 V, externally adjustable and with flexible load distribution. A shut down input allows remote converter on/off. Features include consistently high efficiency over the entire input voltage range, high reliability, and excellent dynamic response to load and line changes.

The converters are designed and built according to the international safety standards IEC/EN/UL 60950, and

approved by TÜV, UL, and cUL. The IMX35 models provide basic insulation.

The circuit is comprised of 2 planar magnetics devices, and all components are automatically assembled and securely soldered onto a single PCB without any wire connection. Magnetic feedback ensures maximum reliability and repeatability in the control loop over all operating conditions. Careful considerations of possible thermal stresses ensure the absence of hot spots providing long life in environments, where temperature cycles are present. The thermal design without using any potting material allows operation at full load up to an ambient temperature of 71 °C in free air and operation up to 110 °C with airflow. For extremely high vibration environments the case has holes for screw mounting.

**Table of Contents**

Table of Contents	Page	Page	
Description .....	1	Electromagnetic Compatibility (EMC) .....	11
Model Selection .....	2	Immunity to Environmental Conditions .....	12
Functional Description .....	3	Mechanical Data .....	13
Electrical Input Data .....	4	Safety and Installation Instructions .....	14
Electrical Output Data .....	6	Options .....	15
Auxiliary Functions .....	9	EC Declaration of Conformity .....	16

## Model Selection

Table 1: Model Selection

Output 1		Output 2		Output 3		Output 4		Input voltage	Eff.	Model	Trim <sup>2</sup>	Opt. <sup>3</sup>
V <sub>O nom</sub> [VDC]	I <sub>O nom</sub> [A]	V <sub>O nom</sub> [VDC]	I <sub>O nom</sub> [A]	V <sub>O nom</sub> [VDC]	I <sub>O nom</sub> [A]	V <sub>O nom</sub> [VDC]	I <sub>O nom</sub> [A]	V <sub>i min</sub> to V <sub>i max</sub> [VDC]	η <sup>1</sup> [%]			
5	1.35	5	1.35	5	1.35	5	1.35	9 to 36	86	20IMX35D05D05-8	primary	i Z G
5	1.4	5	1.4	5	1.4	5	1.4	18 to 75	87	40IMX35D05D05-8		
5	1.4	5	1.4	5	1.4	5	1.4	40 to 121	86	70IMX35D05D05-8		
5	1.4	5	1.4	5	1.4	5	1.4	60 to 150	86	110IMX35D05D05-8		
12	0.65	12	0.65	12	0.65	12	0.65	9 to 36	86	20IMX35D12D12-8	primary	
12	0.7	12	0.7	12	0.7	12	0.7	18 to 75	88	40IMX35D12D12-8		
12	0.7	12	0.7	12	0.7	12	0.7	40 to 121	88	70IMX35D12D12-8		
12	0.7	12	0.7	12	0.7	12	0.7	60 to 150	88	110IMX35D12D12-8		
15	0.55	15	0.55	15	0.55	15	0.55	9 to 36	88	20IMX35D15D15-8	primary	
15	0.6	15	0.6	15	0.6	15	0.6	18 to 75	89	40IMX35D15D15-8		
15	0.6	15	0.6	15	0.6	15	0.6	40 to 121	88	70IMX35D15D15-8		
15	0.6	15	0.6	15	0.6	15	0.6	60 to 150	88	110IMX35D15D15-8		
5	1.35	12	0.65	12	0.65	5	1.35	9 to 36	88	20IMX35D05D12-8	primary	
5	1.4	12	0.7	12	0.7	5	1.4	18 to 75	89	40IMX35D05D12-8		
5	1.4	12	0.7	12	0.7	5	1.4	40 to 121	88	70IMX35D05D12-8		
5	1.4	12	0.7	12	0.7	5	1.4	60 to 150	88	110IMX35D05D12-8		
5	1.35	15	0.55	15	0.55	5	1.35	9 to 36	88	20IMX35D05D15-8	primary	
5	1.4	15	0.6	15	0.6	5	1.4	18 to 75	89	40IMX35D05D15-8		
5	1.4	15	0.6	15	0.6	5	1.4	40 to 121	88	70IMX35D05D15-8		
5	1.4	15	0.6	15	0.6	5	1.4	60 to 150	88	110IMX35D05D15-8		

<sup>1</sup> Typ. efficiency at T<sub>A</sub> = 25 °C, V<sub>O nom</sub>, I<sub>O nom</sub>

<sup>2</sup> The Trim input (pin 5) on the primary side influences all outputs simultaneously on equal-voltage models (e.g., D12D12); for unequal voltages (e.g., D05D12), Trim1 influences only the first power train Vo1/Vo4.

<sup>3</sup> For minimum quantity and lead times contact Power-One.

## Part Number Description

Input voltage range V<sub>i</sub>  
 9 to 36 VDC ..... 20  
 18 to 75 VDC ..... 40  
 40 to 121 VDC ..... 70  
 60 to 150 VDC ..... 110

Series ..... IMX35

Outputs 1 and 4 of quad types ..... D05, D12, D15

Outputs 2 and 3 of quad types ..... D05, D12, D15

Operating ambient temperature range  
 T<sub>A</sub> = -40 to 85 °C (110 °C) ..... -8

Options: Inhibit ..... -i  
 Open frame ..... Z  
 RoHS compliant for all six substances ..... G<sup>1</sup>

<sup>1</sup> G is always placed at the end of the part number.

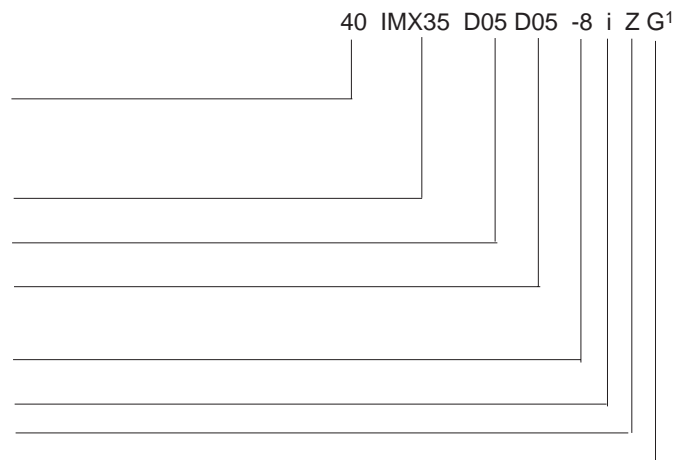

## Product Marking

Converters without option Z are marked with basic type designation, input and output voltages and currents, applicable safety approval and recognition marks, Power-One patent nos., company logo, date code, and serial no.

## Functional Description

The IMX35 converters are comprised of 2 feedback-controlled interleaved-switching flyback power trains using current mode PWM (pulse width modulation).

Each converter consists of 4 electrically isolated outputs deriving from 2 power trains. Vo1, Vo4 derive from the first power train and Vo2, Vo3 from the second one. Thus each pair of outputs is independent from the other one.

Voltage regulation for each pair of outputs is achieved with passive transformer feedback from the main transformer of the power train. Each pair of outputs has the same output voltage (i.e. D05, D12, etc.). If both power trains have the same output

voltage (e.g., D12D12), all outputs may be simultaneously adjusted by the Trim input (pin 5). In case of different output voltages (e.g., D05D15), the Trim1 input influences only Vo1 and Vo4.

Current limitation is provided by the primary circuit for each power train and limits the possible output power for each pair of outputs. In the case of an overload on either of the power trains, which causes the output voltage to fall less than typically 60% of  $V_{o,nom}$ , the entire converter will shut down and automatically restart in short intervals (hiccup mode).

The incorporated overtemperature protection shuts down the converter in excessive overload conditions with automatic restart.

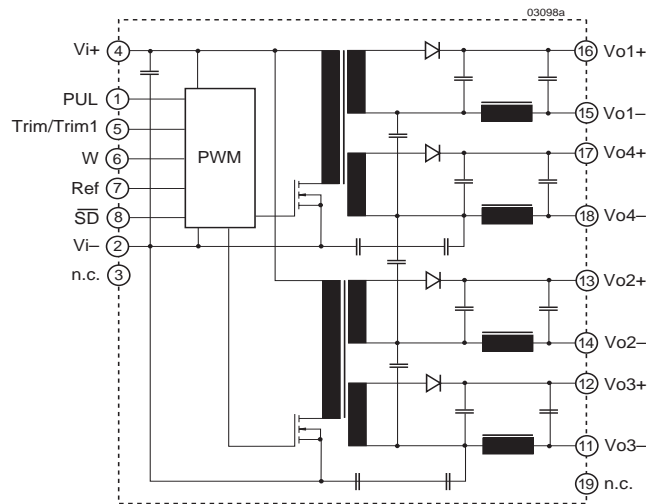

Fig. 1  
Block diagram of quad output models

### Electrical Input Data

General conditions:

$T_A = 25^\circ\text{C}$ , shut down and Trim pin left open-circuit (not connected), unless specified.

Table 2: Input Data

Input			20IMX			40IMX			Unit	
Characteristics		Conditions	min	typ	max	min	typ	max		
$V_i$	Input voltage range <sup>1</sup>		$T_{A\text{ min}}$ to $T_{A\text{ max}}$			$18^2$ 75			VDC	
$V_{i\text{ nom}}$	Nominal input voltage		$I_o = 0$ to $I_{o\text{ nom}}$			40				
$V_{i\text{ sur}}$	Repetitive surge voltage		Abs. max input (3 s)			100				
$t_{\text{start up}}$	Converter start-up time <sup>2</sup>	Switch on	Worst case condition at $V_{i\text{ min}}$ and full load			0.25 0.5		0.25 0.5		s
		SD high				0.1		0.1		
$t_{\text{rise}}$	Rise time <sup>3</sup>		$V_{i\text{ nom}}$ resist load			3		3		ms
			$I_{o\text{ nom}}$ capac. load			6 12		6 12		
$I_{i\text{ o}}$	No load input current		$I_o = 0$ , $V_{i\text{ min}}$ to $V_{i\text{ max}}$			70		50		mA
$I_{\text{irr}}$	Reflected ripple current		$I_o = 0$ to $I_{o\text{ nom}}$			30		30		$\text{mA}_{\text{pp}}$
$I_{\text{inr p}}$	Inrush peak current <sup>4</sup>		$V_i = V_{i\text{ nom}}$			8		9		A
$C_i$	Input capacitance		for surge calculation			2		1.3		$\mu\text{F}$
$V_{\text{SD}}$	Shut down voltage		Converter shut down			-10 to 0.7		-10 to 0.7		VDC
			Converter operating			open circuit or 2 to 20		open circuit or 2 to 20		
$R_{\text{SD}}$	Shut down input resistance		For current calculations			approx. 10		approx. 10		$\text{k}\Omega$
$I_{\text{SD}}$	Input current at shut down		$V_{i\text{ min}}$ to $V_{i\text{ max}}$			12		6		mA
$f_s$	Switching frequency		$V_{i\text{ min}}$ to $V_{i\text{ max}}$ , $I_o = 0$ to $I_{o\text{ nom}}$			approx. 220		approx. 220		kHz

Input			70IMX			110IMX			Unit	
Characteristics		Conditions	min	typ	max	min	typ	max		
$V_i$	Input voltage range <sup>1</sup>		$T_{A\text{ min}}$ to $T_{A\text{ max}}$			$60^2$ 150			VDC	
$V_{i\text{ nom}}$	Nominal input voltage		$I_o = 0$ to $I_{o\text{ nom}}$			110				
$V_{i\text{ sur}}$	Repetitive surge voltage		Abs. max input (3 s)			150		170		
$t_{\text{start up}}$	Converter start-up time <sup>2</sup>	Switch on	Worst case condition at $V_{i\text{ min}}$ and full load			0.25 0.5		0.25 0.5		s
		SD high				0.1		0.1		
$t_{\text{rise}}$	Rise time <sup>3</sup>		$V_{i\text{ nom}}$ resist load			3		3		ms
			$I_{o\text{ nom}}$ capac. load			6 12		6 12		
$I_{i\text{ o}}$	No load input current		$I_o = 0$ , $V_{i\text{ min}}$ to $V_{i\text{ max}}$			30		20		mA
$I_{\text{irr}}$	Reflected ripple current		$I_o = 0$ to $I_{o\text{ nom}}$			30		30		$\text{mA}_{\text{pp}}$
$I_{\text{inr p}}$	Inrush peak current <sup>4</sup>		$V_i = V_{i\text{ nom}}$			7		7		A
$C_i$	Input capacitance		for surge calculation			0.5		0.5		$\mu\text{F}$
$V_{\text{SD}}$	Shut down voltage		Converter shut down			-10 to 0.7		-10 to 0.7		VDC
			Converter operating			open circuit or 2 to 20		open circuit or 2 to 20		
$R_{\text{SD}}$	Shut down input resistance		For current calculations			approx. 10		approx. 10		$\text{k}\Omega$
$I_{\text{SD}}$	Input current at shut down		$V_{i\text{ min}}$ to $V_{i\text{ max}}$			3.5		4		mA
$f_s$	Switching frequency		$V_{i\text{ min}}$ to $V_{i\text{ max}}$ , $I_o = 0$ to $I_{o\text{ nom}}$			approx. 220		approx. 220		kHz

<sup>1</sup>  $V_{i\text{ min}}$  will not be as stated if  $V_o$  is increased above  $V_{o\text{ nom}}$  by use of Trim input. If the output voltage is set to a higher value,  $V_{i\text{ min}}$  will be proportionately increased.

<sup>2</sup> Input undervoltage lockout at typ. 85% of  $V_{i\text{ min}}$ .

<sup>3</sup> Measured with resistive and max. admissible capacitive load.

<sup>4</sup> Source impedance according to ETS 300132-2, version 4.3.

<sup>5</sup> Measured with a lead length of 0.1 m, leads twisted.

### Inrush Current

The inrush current has been kept as low as possible by choosing a very small input capacitance. A series resistor may be installed in the input line in order to further reduce this current.

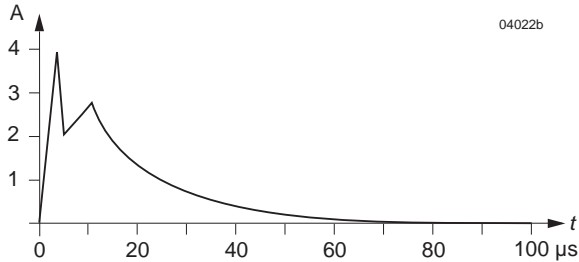

**Fig. 2**  
Typical inrush current at  $V_{i\text{ nom}}$ ,  $P_{o\text{ nom}}$  versus time (40IMX35).  
Source impedance according to ETS 300132-2 at  $V_{i\text{ nom}}$ .

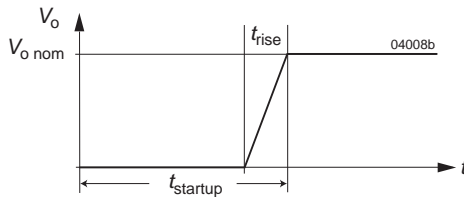

**Fig. 3**  
Converter start-up and rise time

### Reverse Polarity Protection

The built-in suppressor diode also provides for reverse polarity protection at the input by conducting current in the reverse direction. An external fuse is required to limit this current.

**Table 3: Recommended external fuses in the non-earthed input line**

Converter model	Fuse type
20IMX35	F8.0A
40IMX35	F4.0A
70IMX35	F2.0A
110IMX35	F1.5A

### Input Transient Voltage Protection

A built-in suppressor diode provides effective protection against input transients, which may be generated for example by short-circuits across the input lines, where the network inductance may cause high energy pulses.

**Table 4: Built-in transient voltage suppressor**

Model	Breakdown voltage $V_{Br\text{ nom}}$ [V]	Peak power at 1 ms $P_p$ [W]	Peak pulse current $I_{pp}$ [A]
20IMX35	39	1500	22
40IMX35	100	1500	9.7
70IMX35	151	600	2.9
110IMX35	176	600	2.5

For very high energy transients as for example to achieve IEC/EN 61000-4-5 compliance (as per table *Electromagnetic Immunity*) an external inductor and capacitor are required. The components should have similar characteristics as listed in table below.

**Table 5: Components for external circuitry for IEC/EN 61000-4-5, level 2**

Model	Inductor (L)	Capacitor (C)	Diode (D)
20IMX35	22 $\mu$ H/5 A	470 $\mu$ F/40 V	1.5 k E47A
40IMX35	68 $\mu$ H/2.7 A	2 x 100 $\mu$ F/100 V	-
70IMX35	100 $\mu$ H/1 A	2 x 82 $\mu$ F/200 V	-
110IMX35	150 $\mu$ H/0.8 A	2 x 82 $\mu$ F/200 V	-

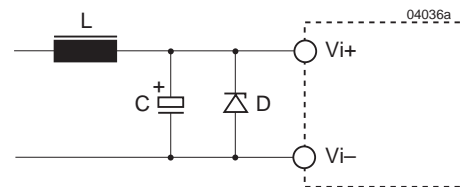

**Fig. 4**  
Example for external circuitry to comply with IEC/EN 61000-4-5; the diode D is only necessary for 20IMX35 models.

## Electrical Output Data

General conditions:

- $T_A = 25\text{ °C}$ , unless  $T_C$  is specified
- Shutdown pin left open-circuit (not connected)
- Trim not connected

Table 6: Output data for double-output power trains ( $V_{o1}/V_{o4}$  or  $V_{o2}/V_{o3}$ , i.e. each power train has 2 outputs)

Output			2 x 5 V			2 x 12 V			2 x 15 V			Unit		
Characteristics	Conditions		min	typ	max	min	typ	max	min	typ	max			
$V_{o1}$ $V_{o2}$	Output voltage		$V_{i\text{ nom}}$ $I_o = 0.5 I_{o\text{ nom}}$	4.95 4.94	5.05 5.06	11.88 11.86	12.12 12.14	14.85 14.82	15.15 15.18			VDC		
$I_{o\text{ nom}}$	Output current	20IMX 40IMX 70IMX 110IMX	$V_{i\text{ min}}$ to $V_{i\text{ max}}$			2 x 1.35			2 x 0.65			2 x 0.55		A
$I_{oL}$	Current limit <sup>1</sup>	20IMX 40IMX 70IMX 110IMX	$V_{i\text{ nom}}, T_C = 25\text{ °C}$ $V_o = 93\% V_{o\text{ nom}}$			3.5 3.8 3.8 3.8			1.8 2.0 2.0 2.0			1.5 1.7 1.7 1.7		
$\Delta V_o$	Line regulation		$V_{i\text{ min}}$ to $V_{i\text{ max}}, I_{o\text{ nom}}$			$\pm 1$			$\pm 1$			$\pm 1$		%
$\Delta V_{o1}$	Load regulation		$V_{i\text{ nom}}$ $I_o = (0.1 \text{ to } 1) I_{o\text{ nom}}$			$\pm 3$			$\pm 3$			$\pm 3$		
$V_{o1/2}$	Output voltage noise		$V_{i\text{ min}}$ to $V_{i\text{ max}}$ $I_o = I_{o\text{ nom}}$			80 40			120 60			150 70		mV <sub>pp</sub>
$V_{oL}$	Output overvoltage limit. <sup>4</sup>		Min. load 1%			115 130			115 130			115 130		%
$C_{o\text{ ext}}$	Admissible capacitive load					4000			470			330		μF
$V_{o\text{ d}}$	Dynamic load regulation	Voltage deviat.	$V_{i\text{ nom}}$			$\pm 250$			$\pm 480$			$\pm 520$		mV
$t_d$		Recovery time	$I_{o\text{ nom}} \leftrightarrow 1/2 I_{o\text{ nom}}$			0.75			0.75			0.75		ms
$\alpha_{V_o}$	Temperature coefficient $\Delta V_o/\Delta T_C$		$V_{i\text{ min}}$ to $V_{i\text{ max}}$ $I_o = (0.1 \text{ to } 1) I_{o\text{ nom}}$			$\pm 0.02$			$\pm 0.02$			$\pm 0.02$		%/K

<sup>1</sup> Both outputs connected in parallel. The current limit is primary side controlled. In the event of a sustained overload condition the thermal protection may cause the converter to shut down (restart on cool-down).

<sup>2</sup> BW = 20 MHz, measured with an external capacitor of 1 μF across each output pin.

<sup>3</sup> Measured with a probe according to EN 61204

<sup>4</sup> The overvoltage protection is via a primary side second regulation loop, not tracking with Trim control.

### Thermal Considerations

If a converter, mounted on a PCB, is located in free, quasi-stationary air (convection cooling) at the indicated maximum ambient temperature  $T_{A \text{ max}}$  (see table *Temperature specifications*) and is operated at its nominal input voltage and output power, the case temperature  $T_C$  measured at the measuring point of case temperature (see *Mechanical Data*) will approach the indicated value  $T_{C \text{ max}}$  after the warm-up phase. However, the relationship between  $T_A$  and  $T_C$  depends heavily on the conditions of operation and integration into a system. The thermal conditions are influenced by input voltage, output current, airflow, temperature of surrounding components and the surfaces and properties of the printed circuit board.  $T_{A \text{ max}}$  is therefore only an indicative value, and under practical operating conditions, the ambient temperature  $T_A$  may be higher or lower than this value.

**Caution:** The case temperature  $T_C$  measured at the measuring point of case temperature  $T_C$  (see *Mechanical Data*) may under no circumstances exceed the specified maximum value. The installer must ensure that under all operating conditions  $T_C$  remains within the limits stated in the table *Temperature specifications*.

The converters provide the specified output power with free air convection cooling. In the upper temperature range the output power derating below should be observed.

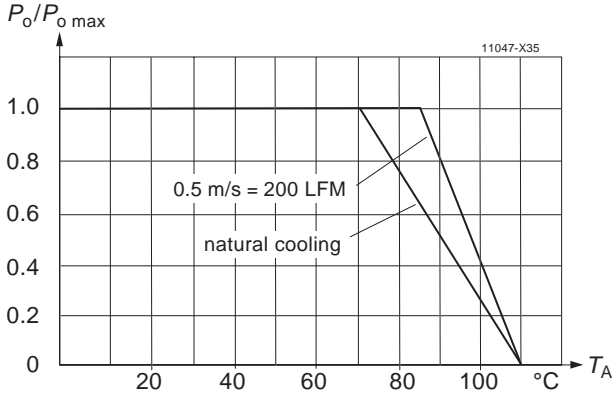

Fig. 5  
Maximum allowed output power versus ambient temperature.

### Overtemperature Protection

The converter is protected against possible overheating by means of an internal temperature monitoring circuit. It shuts down the converter above the internal temperature limit and attempts to automatically restart. This feature prevents excessive internal temperature building up which could occur under heavy overload conditions.

### Short Circuit Behavior

The current limit characteristic shuts down the converter whenever a short circuit is applied to an output. It acts self-protecting and automatically recovers after removal of the overload condition (hiccup mode).

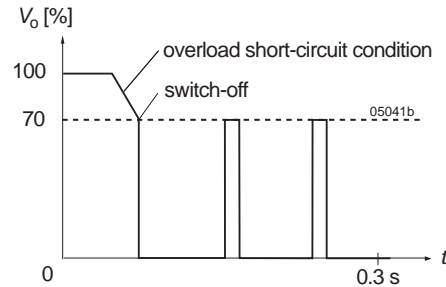

Fig. 6  
Overload switch off (hiccup mode), typical values.

### Connection in Series

The outputs of one or several double output power trains may be connected in series without any precautions.

### Connection in Parallel

Several outputs of the same converter with equal output voltage (e.g., 5 V / 5 V) can be connected in parallel and will share their output currents almost equally.

If outputs from the same converter are being paralleled together, it is recommended that outputs from the same power trains are connected together first.

**Note:** A separate application note is available for uses when all outputs are paralleled together.

Parallel operation of several converters with the same output voltage may cause start-up problems at initial start-up. This is only advisable in applications where one converter is able to deliver the full load current as is required in true redundant systems. It is recommended not to parallel more than three units at full load.

**Typical Performance Curves**

General conditions:

- $T_A = 25^\circ\text{C}$ , unless  $T_C$  is specified.
- Shut down and Trim pin left open-circuit.

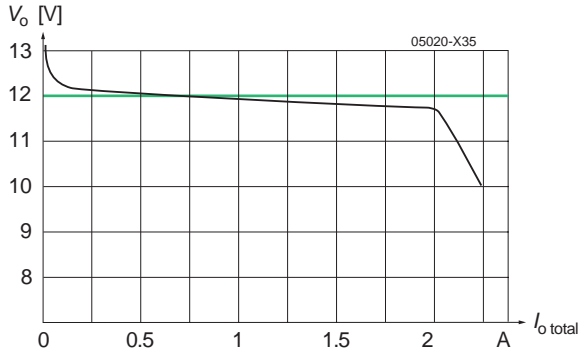

Fig. 7

$V_o$  versus  $I_o$  (typ.) of double-output power trains, with both outputs in parallel (e.g.,  $V_{o1/4}$  of a 40IMX35D12D12)

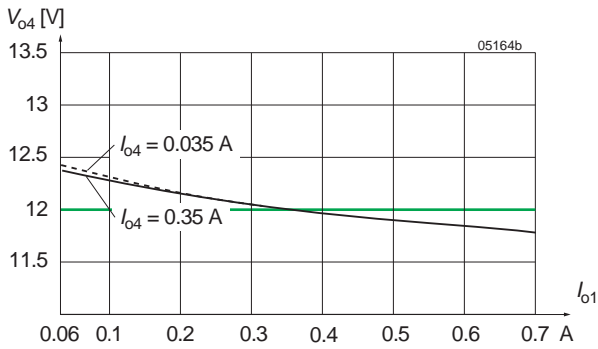

Fig. 8

Cross load regulation (typ.) on power train 1.  $V_{o4}$  versus  $I_{o1}$

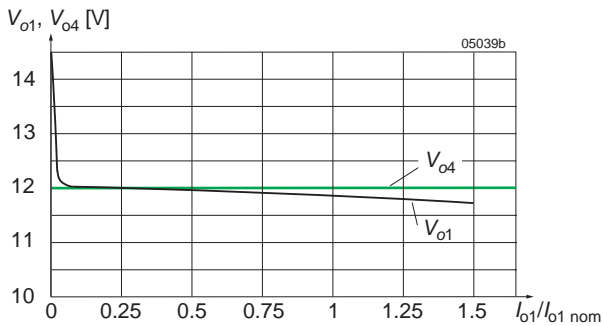

Fig. 9

Flexible load distribution (typ.) on power train 1 of a 40IMX35D12D12-8:

$V_{o1}$  versus  $I_{o1}$ ,  $I_{o4} = 0.5 I_{o4 \text{ nom}}$

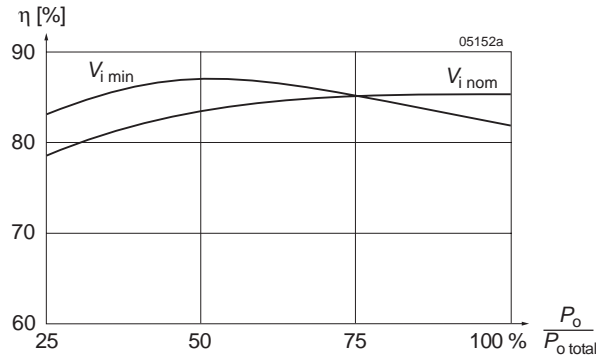

Fig. 10

Efficiency versus input voltage and load. Typical values (40IMX35D12D12-8)

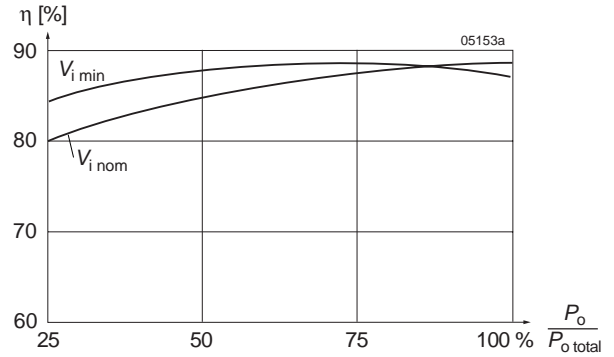

Fig. 11

Efficiency versus input voltage and load. Typical values (20IMX35D12D12-8)



## Auxiliary Functions

### Adjustable Output Voltage

As a standard feature, the IMX35 offer adjustable output voltages in the range of 85 to 105% of  $V_{o\text{ nom}}$ . Fig. 12 shows the schematic diagram for the adjustment of quad-output models.

All models with equal output voltages have the trim function connected to pin 5 referenced to the primary side, influencing all outputs simultaneously. However, the Trim1 input of models with different output voltage on the power trains influences only the first power train.

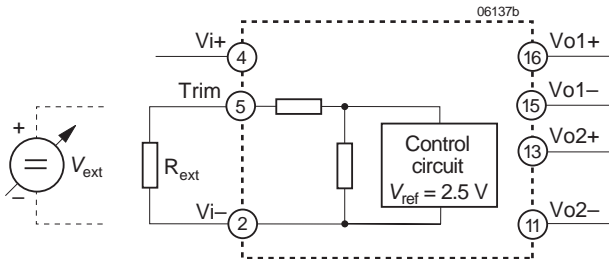

Fig. 12

Output voltage control by means of the Trim input

### Adjustment by means of an external resistor $R_{\text{ext}}$ :

Adjustment of the output voltage by means of an external resistor  $R_{\text{ext}}$  is possible within the range of 100 to 105% of  $V_{o\text{ nom}}$ .  $R_{\text{ext}}$  should be connected between Trim (pin 5) and  $V_{i-}$  (pin 2). The following table indicates suitable resistor values for typical output voltages under nominal conditions ( $V_{i\text{ nom}}$ ,  $I_o = 0.5 I_{o\text{ nom}}$ ).

Note: Connection of  $R_{\text{ext}}$  to  $V_{i+}$  may damage the converter.

Table 7:  $R_{\text{ext}1}$  for  $V_o > V_{o\text{ nom}}$ ;  
approximate values ( $V_{i\text{ nom}}$ ,  $I_o = 0.5 I_{o\text{ nom}}$ )

$V_o$ [% $V_{o\text{ nom}}$ ]	$R_{\text{ext}}$ [k $\Omega$ ]	
	Trim [k $\Omega$ ]	Trim1 [k $\Omega$ ]
105 to 108 (107 typically)	0	0
105	10	17
102	62	110
100	$\infty$	$\infty$

### Adjustment by means of an external voltage source $V_{\text{ext}}$

For external output voltage adjustment in the range 85 to 105% of  $V_{o\text{ nom}}$  a voltage source  $V_{\text{ext}}$  (0 to 20 V) is required, connected to Trim or Trim1 (pin 5) and  $V_{i-}$ . The table below indicates typical values  $V_o$  versus  $V_{\text{ext}}$ . Applying a control voltage of 15 to 20 V will set the converter into the hiccup mode. Direct paralleling of the Trim pins of converters of the same type connected in parallel is feasible.

Table 8:  $V_o$  versus  $V_{\text{ext}}$  for  $V_o = 85$  to 105%  $V_{o\text{ nom}}$ ;  
typical values ( $V_{i\text{ nom}}$ ,  $I_o = 0.5 I_{o\text{ nom}}$ )

$V_o$ [% $V_{o\text{ nom}}$ ]	$V_{\text{ext}}$ [V]	
	Trim [V]	Trim 1 [V]
>105	0	0
102	1.8	1.5
100	2.5	2.5
95	4.3	4.25
90	6.2	6.2
85	8	8

### Synchronization (W)

It is possible to synchronize the switching frequency of one or more converters to an external symmetrical clock signal. If this option is required, consult factory for full application details.

This logic input W can be used to synchronize the oscillator to an external frequency source. This signal is edge-triggered with TTL thresholds, and requires a source frequency of 490 to 540 kHz (duty cycle 10 to 90%). The external source frequency is internally divided by 2 to define the switching frequency for the converter. If unused, this pin can be connected to  $V_{1-}$  (pin 2) or left open-circuit.

### Reference Output (Ref)

The converter provides a stable 5 V ( $\pm 0.1$  V) reference signal on pin 7 (Ref). The output is protected by a 1 k $\Omega$  resistor. The signal may be used also in conjunction with the Trim input (pin 5) as a limited external voltage reference.

It is recommended to connect a filter capacitor (0.1  $\mu\text{F}$ ) between Ref and  $V_{i-}$ , if Ref is used.

### Shutdown

The outputs of the converters may be enabled or disabled by means of a logic signal (TTL, CMOS, etc.) applied to shut down (pin 8). If the shut down function is not required, then pin 8 should be left open-circuit:

Converter operating:	2.0 to 20 V
Converter disabled:	-10 to 0.7 V

**Option i: Inhibit (Negative Shutdown Logic)**

The output of the converter may be enabled or disabled by means of a logic signal (TTL, CMOS, etc.) applied to the inhibit pin 8. No output voltage overshoot will occur, when the converter is turned on. If the inhibit function is not required the inhibit (pin 8) should be connected to Vi- to enable the output (active low logic, fail safe). Voltage on pin 8:

- Converter operating:                 -10 V to 0.8 V
- Converter disabled:                2.4 V to 20 V or left open-circuit

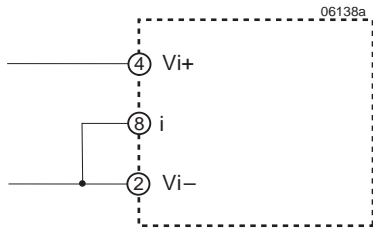

Fig. 13

If the inhibit is not used, the inhibit pin should be connected to Vi-.

**Progr. Input Undervoltage Lockout PUL**

A special feature of these converters is the accurate undervoltage lockout protection, which protects the converter (and the system) from large currents caused by operation at low voltages. This ensures easier start-up in distributed power systems.

Table 9: Turn on and turn off voltage

Model	Trigger level	Hysteresis	Unit
20IMX35	7 to 8	<0.5	V
40IMX35	14 to 15.5	<1	
70IMX35	31 to 34	<3	
110IMX35	42 to 50	<8	

The undervoltage lockout levels may be programmed by use of an external resistor  $R_{PUL}$  to increase the preset levels as indicated in the table below.

Table 10: Typical values for  $R_{PUL}$  and the respective lockout voltage for input voltage.

20IMX35		40IMX35	
$R_{PUL}$ [kΩ]	$V_{i\ min}$ [V]	$R_{PUL}$ [kΩ]	$V_{i\ min}$ [V]
∞	≤ 8	∞	≤ 15.5
39	10	43	22
19	12	16	26
13	14	10	28
9.1	16	0	32

70IMX35		110IMX35	
$R_{PUL}$ [kΩ]	$V_{i\ min}$ [V]	$R_{PUL}$ [kΩ]	$V_{i\ min}$ [V]
∞	31	∞	42
270	40	270	50
110	50	120	60
80	55	51	75

## Electromagnetic Compatibility (EMC)

A suppressor diode together with an input filter form an effective protection against high input transient voltages which

typically occur in many installations, but especially in battery-driven mobile applications.

## Electromagnetic Immunity

Table 11: Immunity type tests

Phenomenon	Standard	Class Level	Coupling mode <sup>1</sup>	Value applied	Waveform	Source Imped.	Test procedure	In oper.	Per- <sup>2</sup> form.
Electrostatic discharge to case	IEC/EN 61000-4-2	2	contact discharge (Trim pin open)	4000 V <sub>p</sub>	1/50 ns	330 Ω	10 positive and 10 negative discharges	yes	B
		3	air discharge (Trim pin open)	8000 V <sub>p</sub>					
Electromagnetic field	IEC/EN 61000-4-3	3 <sup>3</sup>	antenna	10 V/m	AM 80% 1 kHz	n.a.	80 to 1000 MHz	yes	A
	ENV 50204	3	antenna	10 V/m	PM, 50% duty cycle, 200 Hz repetition frequ.	n.a.	900 MHz	yes	A
Electrical fast transients/burst	IEC/EN 61000-4-4	4	direct +i/-i	4000 V <sub>p</sub>	bursts of 5/50ns 2.5/5 kHz over 15 ms, burst period 300 ms	50 Ω	60 s positive, 60 s negative transients per coupling mode	yes	B
Surges	IEC/EN 61000-4-5	3 <sup>4</sup>	+i/-i	2000 V <sub>p</sub>	1.2/50 μs	2 Ω	5 pos. and 5 neg. surges	yes	B
	EN 50155: 2001	A <sup>5</sup>	+i/c, -i/c	1800 V <sub>p</sub>	5/50 μs	100 Ω		yes	B
		B <sup>6</sup>	+i/c, -i/c	8400 V <sub>p</sub>	0.05/0.1 μs	100 Ω		yes	B
RF Conducted immunity	IEC/EN 61000-4-6	3	+i/-i	10 VAC (140 dBμV)	AM modulated 80%, 1 kHz	50 Ω	0.15 to 80 MHz 150 Ω	yes	A

<sup>1</sup> i = input, o = output.

<sup>2</sup> A = normal operation, no deviation from specification, B = temporary deviation from specs. possible.

<sup>3</sup> Corresponds to EN 50121-3-2:2000, table 9.1

<sup>4</sup> External components required; see fig. 4

<sup>5</sup> Corresponds to EN 50155:1995, waveform D

<sup>6</sup> Corresponds to EN 50155:1995, waveform G

## Electromagnetic Emission

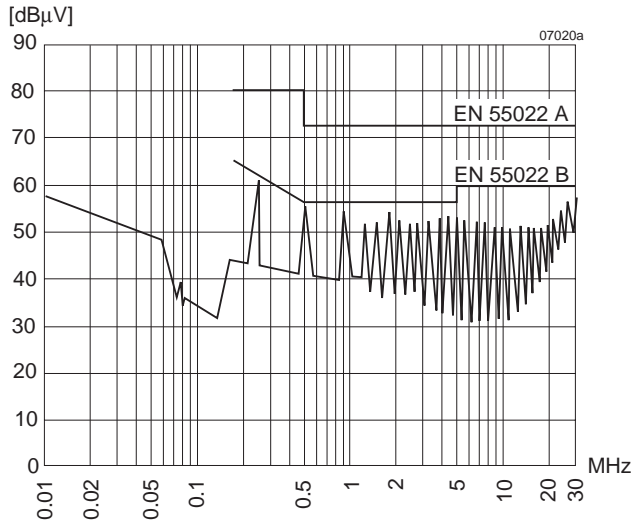

Fig. 14  
Typical disturbance voltage (quasi-peak) at the input according to EN 55011/22, measured at  $V_{i\text{nom}}$  and  $I_{o\text{nom}}$ . Output leads 0.1 m, twisted (40IMX35D12D12-8).

### Radiated Emissions

Radiated emission requirements according to EN 55011/55022, class B, can be achieved by adding an external common mode choke and for 20IMX35 models an additional capacitor (4.7  $\mu$ F/ 50 V). The filter components should be

placed as close as possible to the input of the converter; see figure below.

Table 12: Input filter components for EN 55011/55022, level B, radiated (30 to 1000 MHz)

Type	Current compensated choke
20IMX35	Murata PLH1OA series 7003R6P02
40IMX35	Murata PLH1OA series 1612R1P02
70IMX35	Murata PLH1OA series 2911R2P02
110IMX35	Murata PLH1OA series 3711R0P02

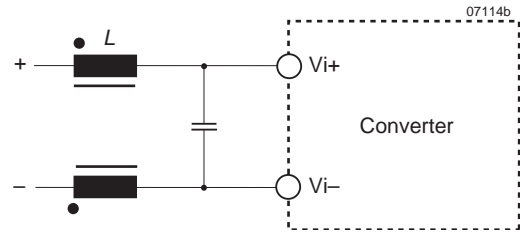

Fig. 15

External circuitry to comply with EN 55011/55022, level B, radiated

### Immunity to Environmental Conditions

Table 13: Environmental testing

Test Method		Standard	Test Conditions	Status
Cab	Damp heat steady state	IEC/EN 60068-2-78 MIL-STD-810D sect. 507.2	Temperature: 40 $\pm$ 2 $^{\circ}$ C Relative humidity: 93 $^{+2/-3}$ % Duration: 56 days	Converter not operating
Ea	Shock (half-sinusoidal)	IEC/EN 60068-2-27 <sup>1</sup> MIL-STD-810D sect. 516.3	Acceleration amplitude: 100 $g_n = 981$ m/s <sup>2</sup> Bump duration: 6 ms Number of bumps: 18 (3 each direction)	Converter operating
Eb	Bump (half-sinusoidal)	IEC/EN 60068-2-29 MIL-STD-810D sect. 516.3	Acceleration amplitude: 40 $g_n = 392$ m/s <sup>2</sup> Bump duration: 6 ms Number of bumps: 6000 (1000 each direction)	Converter operating
Fc	Vibration (sinusoidal)	IEC/EN 60068-2-6	Acceleration amplitude: 0.35 mm (10 to 60 Hz) 5 $g_n = 49$ m/s <sup>2</sup> (60 to 2000 Hz) Frequency (1 Oct/min): 10 to 2000 Hz Test duration: 7.5 h (2.5 h each axis)	Converter operating
Fn	Vibration broad-band random (digital control)	IEC/EN 60068-2-64	Acceleration spectral density: 0.05 $g_n^2$ /Hz Frequency band: 20 to 500 Hz Acceleration magnitude: 4.9 $g_{n\ rms}$ Test duration: 3 h (1 h each axis)	Converter operating
Kb	Salt mist, cyclic (sodium chloride NaCl solution)	IEC/EN 60068-2-52	Concentration: 5% (30 $^{\circ}$ C) Duration: 2 h per cycle Storage: 40 $^{\circ}$ C, 93% rel. humidity Storage duration: 22 h per cycle Number of cycles: 3	Converter not operating

<sup>1</sup> Covers also EN 50155/EN 61373 (Category 1, body mounted, Class B)

**Temperatures**

Table 14: Temperature specifications, valid for air pressure of 800 to 1200 hPa (800 to 1200 mbar)

Temperature			-8		Unit
Characteristics		Conditions	min	max	
$T_A$	Ambient temperature	Operational <sup>1</sup>	-40 <sup>2</sup>	85 <sup>1</sup>	°C
$T_C$	Case temperature		-40 <sup>2</sup>	110	
$T_S$	Storage temperature	Non operational	-55 <sup>2</sup>	110	

<sup>1</sup> See *Thermal Considerations*

<sup>2</sup> Start up at -55 °C

**Reliability**

Table 15: MTBF at nom. load

Model	Ground benign 40 °C	Ground fixed		Ground mobile 50 °C	Device hours <sup>1</sup>	Unit
		40 °C	70 °C			
40IMX35 (MIL-HDBK-217F, $T_C$ )	336 000	141 000	86 000	110 000	396 000	h
110IMX35 (Bellcore, $T_A$ )	1445 000	529 000	294 000	144 000		

<sup>1</sup> The device hours are based upon the IMX35 series field failure rate recorded between 2000 and 2005

**Mechanical Data**

Dimensions in mm.

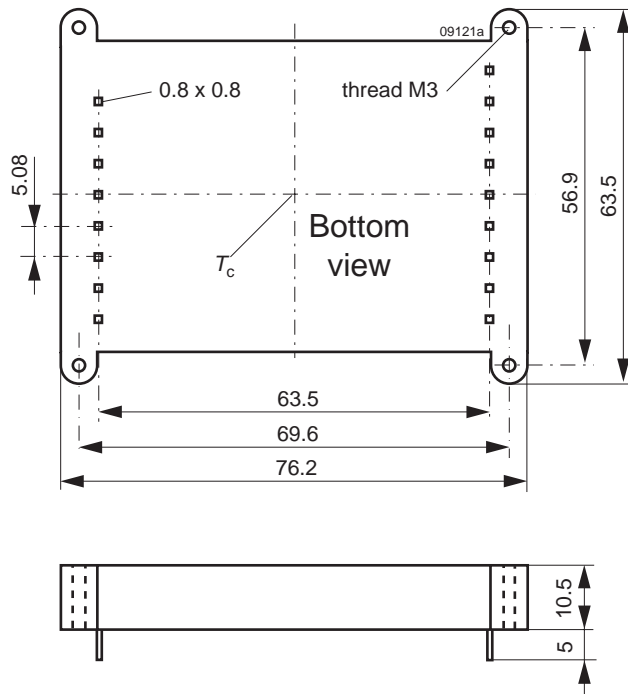

Fig. 16  
Case IMX35 (Standard)  
Weight: approx. 67 g

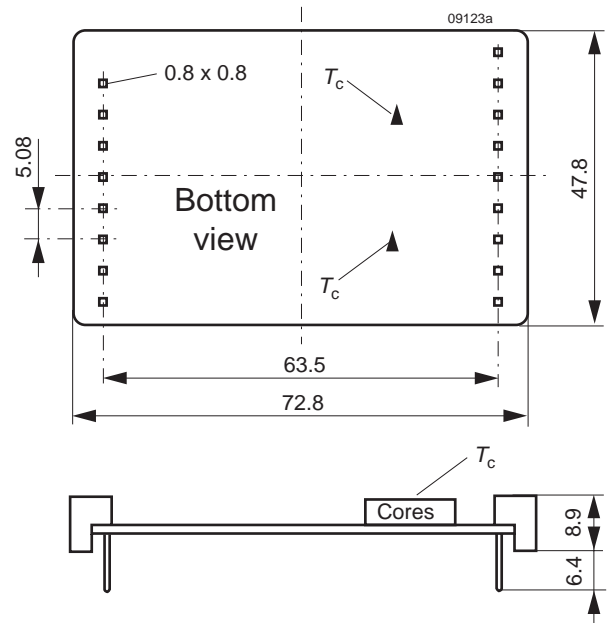

Fig. 17  
Case IMX35 open frame (option Z)  
Weight: approx. 43 g

## Safety and Installation Instructions

### Pin allocation

Table 16: Pin allocation

Pin No.	Quadruple output
1	PUL
2	Vi-
3	n.c.
4	Vi+
5	Trim or Trim1
6	W
7	Ref
8	$\overline{SD}$
11	Vo3-
12	Vo3+
13	Vo2+
14	Vo2-
15	Vo1-
16	Vo1+
17	Vo4+
18	Vo4-
19	n.c.

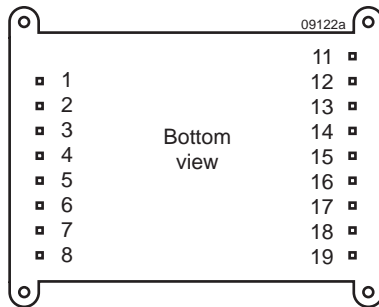

Fig. 18

Footprint. The holes in the PCB should have a diameter of 1.5 mm.

### Installation Instructions

Installation of the converters must strictly follow the national safety regulations in compliance with the enclosure, mounting, creepage, clearance, casualty, markings, and segregation requirements of the end-use application.

Connection to the system shall be made via a printed circuit board with hole diameters of 1.5 mm for the pins.

The converters should be connected to a secondary circuit.

Do not open the converter.

Ensure that a converter failure (e.g., by an internal short-circuit) does not result in a hazardous condition.

### Input Fuse

To prevent excessive current flowing through the input supply line in case of a short-circuit in the converter, an external fuse should be installed in the non-earthed input line. We recommend a fast acting fuse specified in table 3.

### Standards and Approvals

All converters are approved according to the standards UL 60950-1, CSA 60950-1, and IEC/EN 60950-1:2001.

The converters have been evaluated for:

- Building-in
- Basic insulation input to output, based on their maximum input voltage
- Pollution degree 2 (not option Z)
- Connecting the input to a secondary circuit, which is subject to a maximum transient rating of 1500 V.

The converters are subject to manufacturing surveillance in accordance with the above mentioned standards.

CB scheme is available (DE3-52559M3).

### Railway Applications

To comply with Railway standards, all components are coated with a protective lacquer (except for option Z).

### Protection Degree

The protection degree is IP 30 (not for option Z).

### Cleaning Agents

In order to avoid possible damage, any penetration of cleaning fluids should be prevented, since the power supplies are not hermetically sealed.

However, the open-frame models (option Z) leave the factory unlacquered and may be cleaned and lacquered by the customer, for instance together with the motherboard. Contact Power-One for the type of cleaning agents.

## Isolation

The electric strength test is performed in the factory as a routine test in accordance with EN 50116, EN 60950 and UL 60950 and should not be repeated in the field. Power-One will not honor any warranty claims resulting from electric strength field tests.

Table 17: Electric strength test voltages

Characteristic	Input to (outputs+case) 20/40IMX35 <sup>1</sup>	Input to (outputs+case) 70/110IMX35 <sup>1</sup>	Outputs to case all models <sup>1</sup>	Between outputs all models	Unit
Factory test >1 s	1.2	1.8	0.5	0.15 <sup>2</sup>	KVAC
Equivalent DC voltage	1.5	2.5	0.7	0.2 <sup>2</sup>	KVDC
Insulation resistance at 500 VDC	>100	>100	—	—	M Ω

<sup>1</sup> For open-frame models (option Z), only the insulation input to outputs is tested.

<sup>2</sup> The test voltage between outputs is not applied as routine test. For higher isolation between outputs, contact Power-One.

## Options

Table 18: List of options

Option	Function of option	Description
i	Inhibit: Negative shutdown logic	See <i>Auxiliary Functions</i>
Z	Open frame	See <i>Mechanical Data</i>
G <sup>1</sup>	RoHS compliant for all 6 substances	See <i>Model Selection</i>

<sup>1</sup> G is always placed at the end of the part number.

NUCLEAR AND MEDICAL APPLICATIONS - Power-One products are not designed, intended for use in, or authorized for use as critical components in life support systems, equipment used in hazardous environments, or nuclear control systems without the express written consent of the respective divisional president of Power-One, Inc.

TECHNICAL REVISIONS - The appearance of products, including safety agency certifications pictured on labels, may change depending on the date manufactured. Specifications are subject to change without notice.

## EC Declaration of Conformity

---

We

Power-One AG  
Ackerstrasse 56, CH-8610 Uster

declare under our sole responsibility that IMX35 Series DC-DC converters carrying the CE-mark are in conformity with the provisions of the Low Voltage Directive (LVD) 73/23/EEC of the European Communities.

Conformity with the directives is presumed by conformity with the following harmonised standards:

- EN 61204:1995 (= IEC 61204:1993, modified)  
Low-voltage power supply devices, DC output - Performance characteristics and safety requirements
- EN 60950-1:2001 (=IEC 60950-1:2001)  
Safety of information technology equipment.

The installation instructions given in the corresponding data sheet describe correct installation leading to the presumption of conformity of the end product with the LVD. All IMX35 Series DC-DC converters are components, intended exclusively for inclusion within other equipment by an industrial assembly operation or by professional installers. They must not be operated as standalone products.

Hence conformity with the Electromagnetic Compatibility Directive 89/336/EEC (EMC Directive) needs not to be declared. Nevertheless, guidance is provided in the data sheets on how conformity of the end product with EMC standards under the responsibility of the installer can be achieved, from which conformity with the EMC Directive can be presumed.

---

Uster, 14 Nov. 2005

Power-One AG



Rolf Baldauf  
Vice-President Engineering



Johann Milavec  
Director Projects and IP