



SM10T Series Miniature SMD Crystal

November 2008



- Pletronics' SM10T Series is a miniature surface mount crystal.
- Package is ideal for automated surface mount assembly and reflow practices.
- Tape and Reel packaging
- 16 MHz to 60 MHz
- 2.5 x 3.2 mm 4 pad
- AT Cut Fundamental Crystal
- Ideal for use in hand held consumer products

**Pletronics Inc. certifies this device is in accordance with the
RoHS 6/9 (2002/95/EC) and WEEE (2002/96/EC) directives.**

Pletronics Inc. guarantees the device does not contain the following:

Cadmium, Hexavalent Chromium, Lead, Mercury, PBB's, PBDE's

Weight of the Device: 0.06 grams

Moisture Sensitivity Level: 1 As defined in J-STD-020C

Second Level Interconnect code: e4

Electrical Specification:

Item	Min	Max	Unit	Condition
Frequency Range	12	60	MHz	
Calibration Frequency Tolerance	10	50	ppm	at +25°C ± 3°C, see part number for options
Frequency Stability	3	150	ppm	see part number for available options
Equivalent Series Resistance (ESR)	-	100	Ohms	to 30 MHz
	-	50	Ohms	above 30 MHz
Drive Level	-	100	µW	use 10 µW for testing
Shunt Capacitance (C0)	-	5	pF	Pad to Pad capacitance
Aging at 25°C ± 3°C	-5	+5	ppm /Yr	for the first year
	-2	+2	ppm /Yr	after the first year
Operating Temperature Range	-40	+125	°C	see part number for available options
Storage Temperature Range	-55	+125	°C	

AT Cut Crystal Frequency versus Temperature Typical Performance:

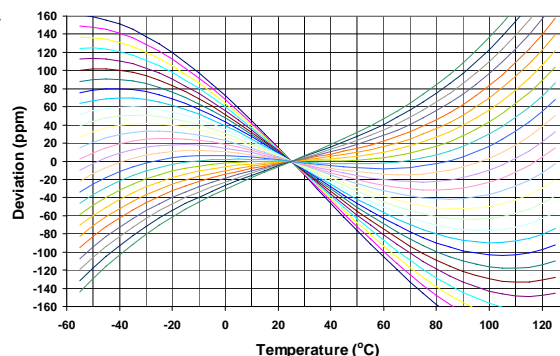

Part Number:

SM10T -18 -16.384M -20 E 1 L K -XX

See chart below for available options

Internal code or blank
Highest Specified Operating Temperature A = 40°C G = 70°C N = 100°C B = 45°C H = 75°C P = 105°C C = 50°C J = 80°C R = 110°C D = 55°C K = 85°C S = 115°C E = 60°C L = 90°C T = 120°C F = 65°C M = 95°C U = 125°C
Lowest Specified Operating Temperature A = +10°C F = -15°C L = -40°C B = +5°C G = -20°C M = -45°C C = 0°C H = -25°C N = -50°C D = -5°C J = -30°C P = -55°C E = -10°C K = -35°C
Fundamental mode AT cut crystal
Frequency Stability See chart below
Calibration Frequency Tolerance (Typ. Values shown) 10 = ± 10 ppm at 25°C ± 3°C 15 = ± 15 ppm at 25°C ± 3°C 20 = ± 20 ppm at 25°C ± 3°C 30 = ± 30 ppm at 25°C ± 3°C (Standard)
Frequency in MHZ
Load in pF Parallel Resonance from 06 to 32 pF or SR = Series Resonance
Model Number

Operating Temperature Range	CODE	Available Frequency Stability versus Temperature in ppm									
		A	B	C	D	E	F	G	H	J	K
0 to +45°C	CB	± 3.0	± 5.0	± 8.0	± 10	± 15	± 20	± 30	± 50	± 100	± 150
0 to +50°C	CC	•	•	•	•	•	•	•	•	•	•
0 to +60°C	CE		•	•	•	•	•	•	•	•	•
0 to +70°C	CG		•	•	•	•	•	•	STD	•	•
-10 to +50°C	EC		•	•	•	•	•	•	•	•	•
-10 to +60°C	EE		•	•	•	•	•	•	•	•	•
-10 to +75°C	EH			•	•	•	•	•	•	•	•
-20 to +70°C	GG			•	•	•	•	•	•	•	•
-20 to +75°C	GH				•	•	•	•	•	•	•
-30 to +75°C	JH				•	•	•	•	•	•	•
-30 to +80°C	JJ				•	•	•	•	•	•	•
-30 to +85°C	JK					•	•	•	•	•	•
-35 to +80°C	KJ					•	•	•	•	•	•
-40 to +85°C	LK					•	•	•	•	•	•
-40 to +90°C	LL					•	•	•	•	•	•
-40 to +105°C	LP						•	•	•	•	•
-40 to +125°C	LU								•	•	•

Legacy Part Number (not for new designs):

SM10T	B	E	-18	-23.45M	-XX	
						Internal code or blank
						Frequency in MHz
						Clload in pF Parallel Resonance from 6 to 32 pF or SR = Series Resonance
						Operating Temperature Range Blank = 0 to +70°C (STD) E = -40 to +85°C
						Calibration Tolerance / Frequency Stability Blank = 30/50 (STD) B = 30/30
						Series Model





Reliability: Environmental Compliance

Parameter	Condition
Mechanical Shock	MIL-STD-883 Method 2002, Condition B
Vibration	MIL-STD-883 Method 2007, Condition A
Solderability	MIL-STD-883 Method 2003
Thermal Shock	MIL-STD-883 Method 1011, Condition A

Package Labeling

Label is 1" x 2.6" (25.4mm x 66.7mm)
 Font is Courier New
 Bar code is 39-Full ASCII

Label is 1" x 2.6" (25.4mm x 66.7mm)
 Font is Arial

P/N:  SM10T-16-23.45M-10F1CG
Customer P/N:  12345678
Qty:  1000 D/C  0526

RoHS Compliant 2nd Lvl Interconnect Category=e4 Max Safe Temp=260C for 10s 2X Max

Mechanical:

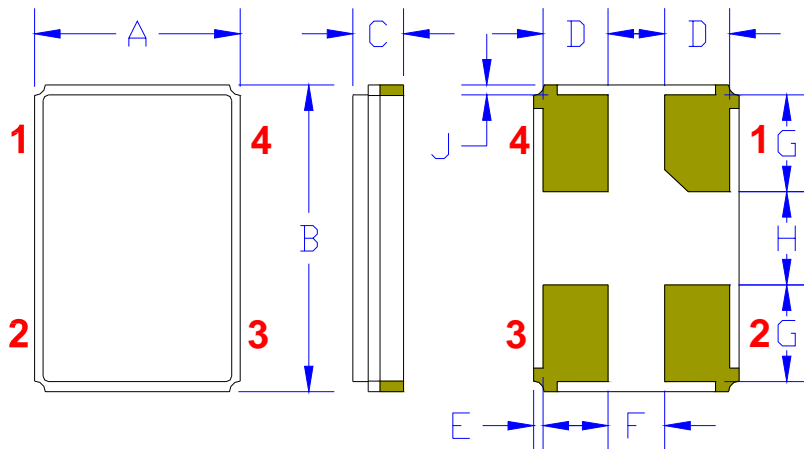

	Inches	mm
A	0.098 ± 0.004	2.5 ± 0.15
B	0.126 ± 0.004	3.2 ± 0.15
C	0.028 max	0.7 max
D ¹	0.028 to 0.031	0.7 to 0.8
E ¹	0.004	0.1
F ¹	A - (2 * (D + E))	
G ¹	0.035	0.9
H ¹	0.047	1.2
J ¹	0.004	0.1

The chamfered pad may or may not be present and may be on any pad

Contacts :

Gold 11.8 μinches 0.3 μm minimum over
Nickel 50 to 350 μinches 1.27 to 8.89 μm

Not to Scale

¹ Typical dimensions

Connection (top view):

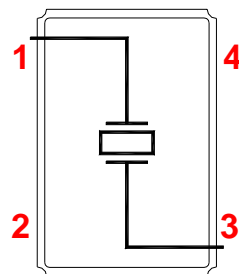

Pad 2 and Pad 4 are common and connected to the metal cover. They are not connected to the crystal.

The crystal is symmetrical, there is no Pad 1 preference. The part can be rotated 180° when being assembled on the PCB and will still perform correctly.



Layout and application information

- Trace lengths to the crystal should be kept as short as possible.
- The crystal connections are sensitive to noise.
- The package should be grounded for optimum performance, pad 2 and/or pad 4 connected to ground.

Marking

- Marking consists of the frequency (may be truncated due to package size) and date code
- Date code consists of Month Year (see codes below)
- Orientation of marking may be mixed on the tape
- Traceability of part is lost once removed from reel

Codes for Date Code (Month Year)

Code	6	7	8	9	0	1	2
Year	2006	2007	2008	2009	2010	2011	2012

Code	A	B	C	D	E	F	G	H	J	K	L	M
Month	JAN	FEB	MAR	APR	MAY	JUN	JUL	AUG	SEP	OCT	NOV	DEC

Reflow Cycle (typical for lead free processing)

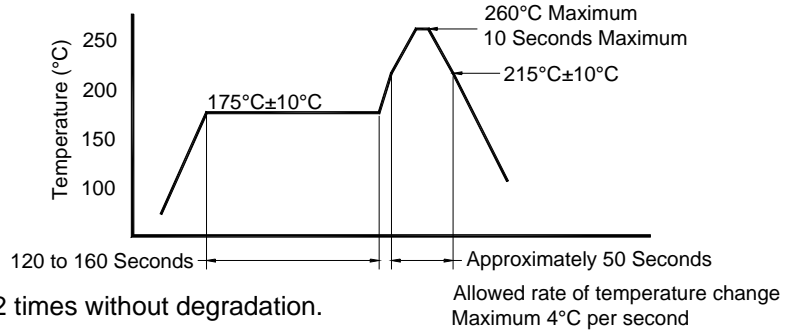

Tape and Reel: available for quantities of 250 to 3000 per reel (<1000 will be cut tape)

Constant Dimensions Table 1								
Tape Size	D0	D1 Min	E1	P0	P2	S1 Min	T Max	T1 Max
8mm	1.5	1.0	1.75	4.0	2.0 ± 0.05	0.6	0.25	0.1
12mm		1.5			2.0 ± 0.1			
16mm		+0.1 -0.0			± 0.1			
24mm		1.5			± 0.1			

Variable Dimensions Table 2							
Tape Size	B1 Max	E2 Min	F	P1	T2 Max	W Max	Ao, Bo & Ko
8 mm	3.5	6.4	1.7 ± 0.1	4.0 ± 0.1	1.0	8.9	Note 1

Note 1: Embossed cavity to conform to EIA-481-B Dimensions in mm Not to scale

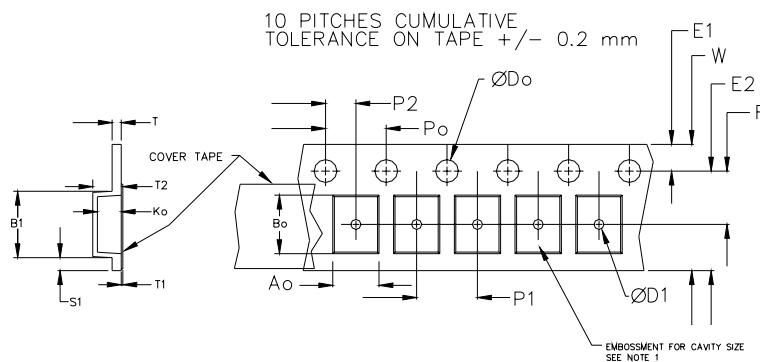
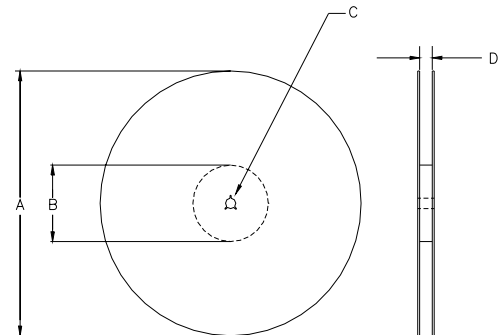

USER DIRECTION OF UNREELING →

REEL DIMENSIONS					
A	inches	7.0	10.0	13.0	Tape Width
	mm	177.8	254.0	330.2	
B	inches	2.50	4.00	3.75	Tape Width
	mm	63.5	101.6	95.3	
C	mm	13.0 +0.5 / -0.2			Tape Width
D	mm	8.4 +2.0 -0.0	8.4 +2.0 -0.0	8.4 +2.0 -0.0	

Reel dimensions may vary from the above

IMPORTANT NOTICE

Pletronics Incorporated (PLE) reserves the right to make corrections, improvements, modifications and other changes to this product at anytime. PLE reserves the right to discontinue any product or service without notice. Customers are responsible for obtaining the latest relevant information before placing orders and should verify that such information is current and complete. All products are sold subject to PLE's terms and conditions of sale supplied at the time of order acknowledgment.

PLE warrants performance of this product to the specifications applicable at the time of sale in accordance with PLE's limited warranty. Testing and other quality control techniques are used to the extent PLE deems necessary to support this warranty. Except where mandated by specific contractual documents, testing of all parameters of each product is not necessarily performed.

PLE assumes no liability for application assistance or customer product design. Customers are responsible for their products and applications using PLE components. To minimize the risks associated with the customer products and applications, customers should provide adequate design and operating safeguards.

PLE products are not designed, intended, authorized or warranted to be suitable for use in life support applications, devices or systems or other critical applications that may involve potential risks of death, personal injury or severe property or environmental damage. Inclusion of PLE products in such applications is understood to be fully at the risk of the customer. Use of PLE products in such applications requires the written approval of an appropriate PLE officer. Questions concerning potential risk applications should be directed to PLE.

PLE does not warrant or represent that any license, either express or implied, is granted under any PLE patent right, copyright, artwork or other intellectual property right relating to any combination, machine or process which PLE product or services are used. Information published by PLE regarding third-party products or services does not constitute a license from PLE to use such products or services or a warranty or endorsement thereof. Use of such information may require a license from a third party under the patents or other intellectual property of the third party, or a license from PLE under the patents or other intellectual property of PLE.

Reproduction of information in PLE data sheets or web site is permissible only if the reproduction is without alteration and is accompanied by associated warranties, conditions, limitations and notices. Reproduction of this information with alteration is an unfair and deceptive business practice. PLE is not responsible or liable for such altered documents.

Resale of PLE products or services with statements different from or beyond the parameters stated by PLE for that product or service voids all express and implied warranties for the associated PLE product or service and is an unfair or deceptive business practice. PLE is not responsible for any such statements.

Contacting Pletronics Inc.

Pletronics Inc.
19013 36th Ave. West
Lynnwood, WA 98036-5761 USA

Tel: 425-776-1880
Fax: 425-776-2760
E-mail: ple-sales@pletronics.com
URL: www.pletronics.com

Copyright © 2006, 2007, 2008, Pletronics Inc.