

## FEATURES

- Differential or Single-Ended Gain Block  $\pm 10$  (20dB)
- -3dB Bandwidth 35MHz
- Slew Rate 500V/ $\mu$ s
- Low Cost
- Output Current  $\pm 50$ mA
- Settling Time 200ns to 0.1%
- CMRR @ 10MHz 45dB
- Differential Gain Error 0.2%
- Differential Phase Error 0.08°
- Input Amplitude Limiting
- Single +5V Operation
- Drives Cables Directly

## APPLICATIONS

- Line Receivers
- Video Signal Processing
- Gain Limiting
- Oscillators
- Tape and Disc Drive Systems

## DESCRIPTION

The LT1194 is a video difference amplifier optimized for operation on  $\pm 5$ V, and a single +5V supply. The amplifier has a fixed gain of 20dB, and features adjustable input limiting to control tough over-drive applications. It has uncommitted high input impedance (+) and (-) inputs, and can be used in differential or single-ended configurations.

The LT1194's high slew rate, 500V/ $\mu$ s, wide bandwidth, 35MHz, and  $\pm 50$ mA output current, make it ideal for driving cables directly. This versatile amplifier is easy to use for video, or applications requiring speed, accuracy, and low cost.

The LT1194 is available in 8-pin miniDIPs and SO packages.

2

Wideband Differential Amplifier  
with Limiting

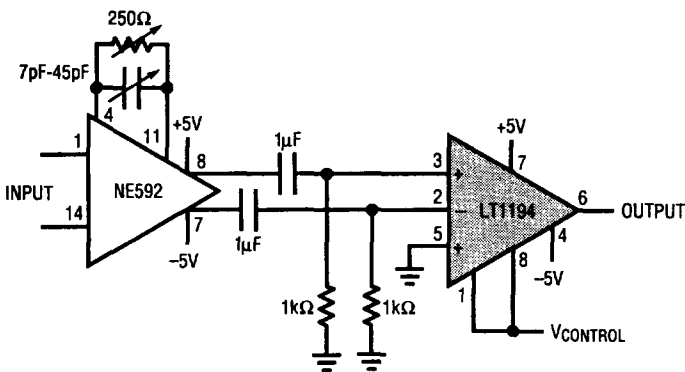

$A_V = 1000$ , -3dB BW = 35MHz

LT1194 - TA01

Sine Wave Reduced by Limiting

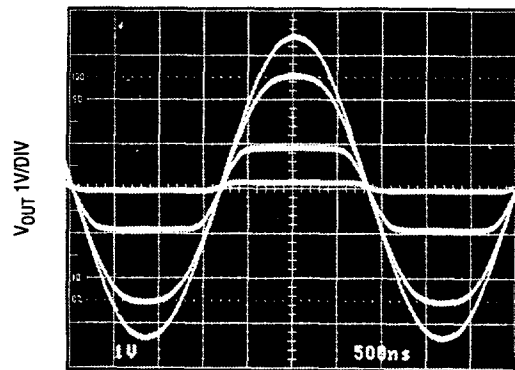

200kHz SINE WAVE WITH  $V_{CONTROL} = -5V, -4V, -3V, -2V$

LT1194 - TA02

**ABSOLUTE MAXIMUM RATINGS**

Total Supply Voltage ( $V^+$  to  $V^-$ ) ..... 18V  
 Differential Input Voltage .....  $\pm 6V$   
 Input Voltage .....  $\pm V_S$   
 Output Short Circuit Duration (Note 1) ..... Continuous  
 Operating Junction Temperature Range  
     LT1194M .....  $-55^\circ C$  to  $150^\circ C$   
     LT1194C .....  $0^\circ C$  to  $150^\circ C$   
 Max. Junction Temperature ..... See Pkg. Descriptions  
 Storage Temperature Range .....  $-65^\circ C$  to  $150^\circ C$   
 Lead Temperature (Soldering, 10 sec.) .....  $300^\circ C$

**PACKAGE/ORDER INFORMATION**

<p>TOP VIEW</p> <p>J8 PACKAGE 8-LEAD HERMETIC DIP              N8 PACKAGE 8-LEAD PLASTIC DIP              S8 PACKAGE 8-LEAD PLASTIC SOIC</p> <p>LT1194 - P001</p>	ORDER PART NUMBER
	LT1194MJ8 LT1194CJ8 LT1194CN8 LT1194CS8
	S8 PART MARKING
	1194

**ELECTRICAL CHARACTERISTICS**

$V_S = \pm 5V$ ,  $V_{REF} = 0V$ , Null pins 1 and 8 open circuit,  $T_A = 25^\circ C$ ,  $C_L \leq 10pF$ , unless otherwise noted.

SYMBOL	PARAMETER	CONDITIONS	LT1194M/C			UNITS
			MIN	TYP	MAX	
$V_{OS}$	Input Offset Voltage			1.0	6.0	mV
$I_{OS}$	Input Offset Current			0.2	3.0	$\mu A$
$I_B$	Input Bias Current			$\pm 0.5$	$\pm 3.5$	$\mu A$
$e_n$	Input Noise Voltage	$f_0 = 10kHz$		15		$nV/\sqrt{Hz}$
$i_n$	Input Noise Current	$f_0 = 10kHz$		4.0		$pA/\sqrt{Hz}$
$R_{IN}$	Input Resistance	Either Input		30		$k\Omega$
$C_{IN}$	Input Capacitance	Either Input		2.0		pF
	Input Voltage Range		-2.5		+3.5	V
CMRR	Common Mode Rejection Ratio	$V_{CM} = -2.5V$ to $+3.5V$	65	80		dB
PSRR	Power Supply Rejection Ratio	$V_S = \pm 2.375V$ to $\pm 8V$	65	80		dB
$V_{OMAX}$	Maximum Output Signal	$V_S = \pm 8V$ , (Note 2)	$\pm 3.9$	$\pm 4.3$		V
$V_{LIM}$	Output Voltage Limit	$V_I = \pm 0.5V$ , $V_C = +2V$ , (Note 3)		$\pm 20$	$\pm 120$	mV
$V_{OUT}$	Output Voltage Swing	$V_S = \pm 8V$ , $V_{REF} = +3V$	$R_L = 1k$	+6.6	+6.9	V
			$R_L = 100\Omega$	+6.3	+6.7	
		$V_S = \pm 8V$ , $V_{REF} = -3V$	$R_L = 1k$	-6.7	-7.4	
			$R_L = 100\Omega$	-6.4	-6.7	
		$V_S = \pm 5V$ , $V_{REF} = 0V$ , $R_L = 1k$	$\pm 3.8$	$\pm 4.0$		
$G_E$	Gain Error	$V_0 = \pm 3V$	$R_L = 1k$	0.5	3.0	%
			$R_L = 100\Omega$	0.5	3.0	
SR	Slew Rate	$V_0 = \pm 1V$ , $R_L = 1k$ , (Note 4, 8)	350	500		$V/\mu s$
FPBW	Full Power Bandwidth	$V_0 = 6Vp-p$ , (Note 5)	18.5	26.5		MHz
BW	Small Signal Bandwidth			35		MHz
$t_r$ , $t_f$	Rise Time, Fall Time	$R_L = 1k$ , $V_0 = \pm 500mV$ , 20% to 80%, (Note 8)	4.0	6.0	8.0	ns
$t_{PD}$	Propagation Delay	$R_L = 1k$ , $V_0 = \pm 125mV$ , 50% to 50%		6.5		ns
	Overshoot	$V_0 = \pm 125mV$		0		%

## ELECTRICAL CHARACTERISTICS

$V_S = \pm 5V$ ,  $V_{REF} = 0V$ , Null pins 1 and 8 open circuit,  $T_A = 25^\circ C$ ,  $C_L \leq 10pF$ , unless otherwise noted.

SYMBOL	PARAMETER	CONDITIONS	LT1194M/C			UNITS
			MIN	TYP	MAX	
$t_s$	Settling Time	3V Step, 0.1%, (Note 6)		200		ns
Diff $A_V$	Differential Gain	$R_L = 150\Omega$ , (Note 7)		0.2		%
Diff Ph	Differential Phase	$R_L = 150\Omega$ , (Note 7)		0.08		Deg p-p
$I_S$	Supply Current			35	43	mA

## ELECTRICAL CHARACTERISTICS

$V_{S+} = +5V$ ,  $V_{S-} = 0V$ ,  $V_{REF} = +2.5V$ , Null pins 1 and 8 open circuit,  $T_A = 25^\circ C$ ,  $C_L \leq 10pF$ , unless otherwise noted.

SYMBOL	PARAMETER	CONDITIONS	LT1194M/C			UNITS
			MIN	TYP	MAX	
$V_{OS}$	Input Offset Voltage			2.0	8.0	mV
$I_{OS}$	Input Offset Current			0.2	3.0	$\mu A$
$I_B$	Input Bias Current			$\pm 0.5$	$\pm 3.0$	$\mu A$
	Input Voltage Range		+2.0		+3.5	V
CMRR	Common Mode Rejection Ratio	$V_{CM} = +2.0V$ to $+3.5V$	55	70		dB
$V_{LIM}$	Output Voltage Limit	$V_i = \pm 0.5V$ , $V_C = +2V$ , (Note 3)		$\pm 20$	$\pm 120$	mV
$V_{OUT}$	Output Voltage Swing	$R_L = 100\Omega$ to Ground	$V_{OUT}$ High	3.6	3.8	V
			$V_{OUT}$ Low		0.25	
SR	Slew Rate	$V_O = +1V$ to $+3V$		250		V/ $\mu s$
BW	Small Signal Bandwidth			32		MHz
$I_S$	Supply Current			32	40	mA

2

## ELECTRICAL CHARACTERISTICS

$V_{S+} = \pm 5V$ ,  $V_{REF} = 0V$ , Null pins 1 and 8 open circuit,  $-55^\circ C \leq T_A \leq 125^\circ C$ , unless otherwise noted.

SYMBOL	PARAMETER	CONDITIONS	LT1194M			UNITS	
			MIN	TYP	MAX		
$V_{OS}$	Input Offset Voltage		●	1.0	9.0	mV	
$\Delta V_{OS}/\Delta T$	Input $V_{OS}$ Drift		●	6.0		$\mu V/^\circ C$	
$I_{OS}$	Input Offset Current		●	0.8	5.0	$\mu A$	
$I_B$	Input Bias Current		●	$\pm 1.0$	$\pm 5.5$	$\mu A$	
	Input Voltage Range		●	-2.5	+3.5	V	
CMRR	Common Mode Rejection Ratio	$V_{CM} = -2.5V$ to $+3.5V$	●	58	80	dB	
PSRR	Power Supply Rejection Ratio	$V_S = \pm 2.375V$ to $\pm 5.0V$	●	60	80	dB	
$V_{LIM}$	Output Voltage Limit	$V_i = \pm 0.5V$ , $V_C = +2V$ , (Note 3)	●	$\pm 20$	$\pm 150$	mV	
$V_{OUT}$	Output Voltage Swing	$V_S = \pm 8V$ $V_{REF} = +3V$	$R_L = 1k$	●	+6.0	+6.6	V
			$R_L = 100\Omega$	●	+5.9	+6.5	
		$V_S = \pm 8V$ $V_{REF} = -3V$	$R_L = 1k$	●	-6.1	-6.7	
			$R_L = 100\Omega$	●	-6.0	-6.5	
$G_E$	Gain Error	$V_O = \pm 3V$ , $R_L = 1k$	●	1.0	5.0	%	
$I_S$	Supply Current		●	35	43	mA	

# LT1194

## ELECTRICAL CHARACTERISTICS

$V_{S+} = \pm 5V$ ,  $V_{REF} = 0V$ , Null pins 1 and 8 open circuit,  $0^{\circ}C \leq T_A \leq 70^{\circ}C$ , unless otherwise noted.

SYMBOL	PARAMETER	CONDITIONS	LT1194C			UNITS
			MIN	TYP	MAX	
$V_{OS}$	Input Offset Voltage	●		1.0	7.0	mV
$\Delta V_{OS}/\Delta T$	Input $V_{OS}$ Drift	●		6.0		$\mu V/^{\circ}C$
$I_{OS}$	Input Offset Current					

# TYPICAL PERFORMANCE CHARACTERISTICS

2

**Input Bias Current vs Common Mode Voltage**

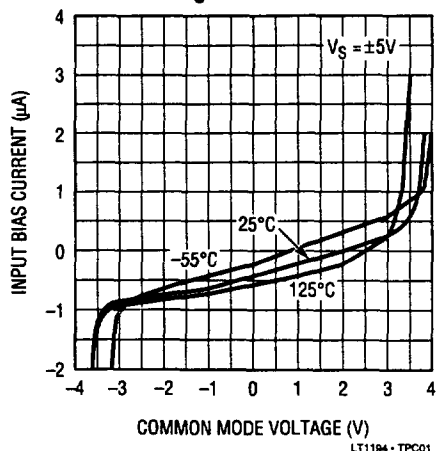

**Input Bias Current vs Temperature**

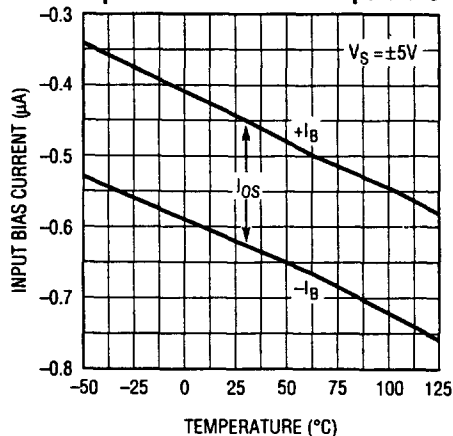

**Common Mode Voltage vs Supply Voltage**

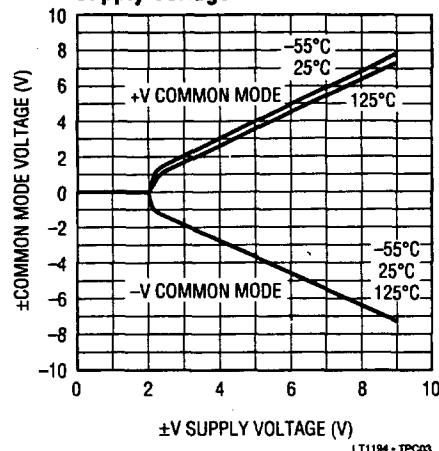

**Equivalent Input Noise Voltage vs Frequency**

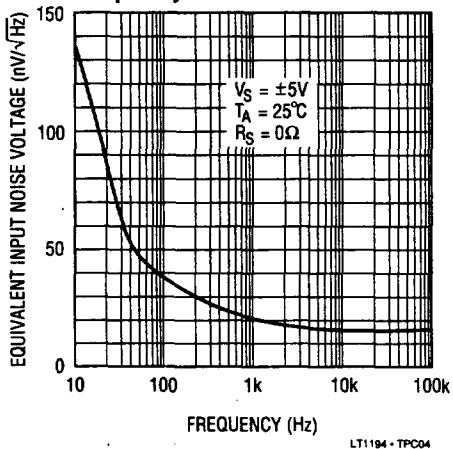

**Equivalent Input Noise Current vs Frequency**

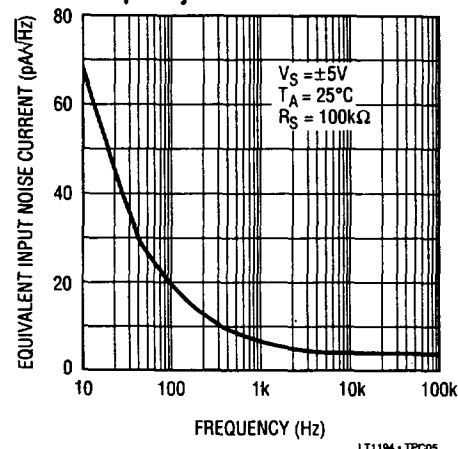

**Supply Current vs Supply Voltage**

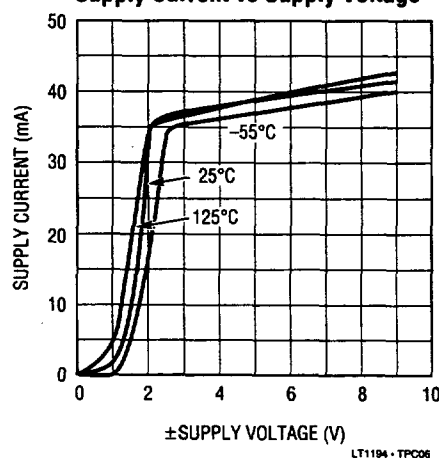

**Gain, Phase vs Frequency**

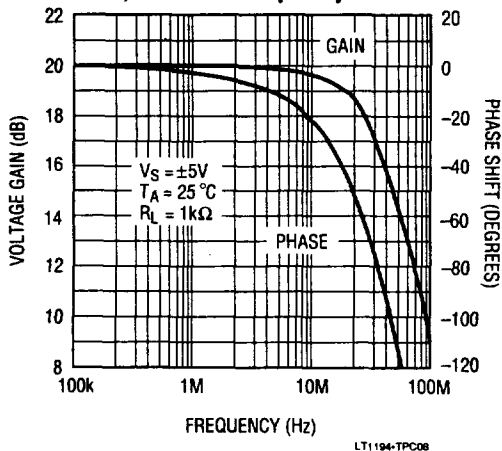

**Gain Error vs Temperature**

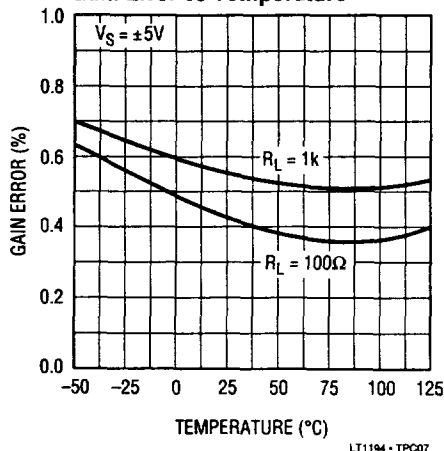

**-3dB Bandwidth vs Supply Voltage**

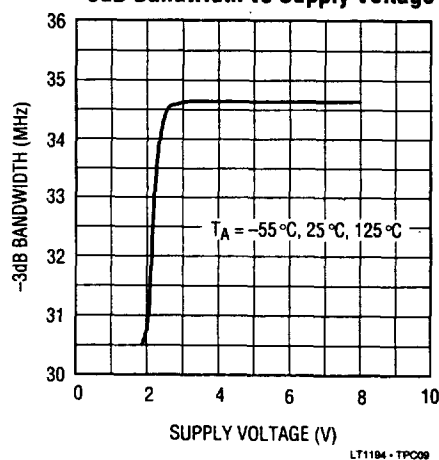

TYPICAL PERFORMANCE CHARACTERISTICS

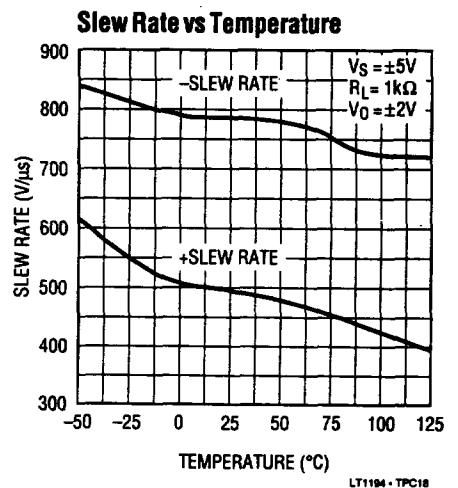
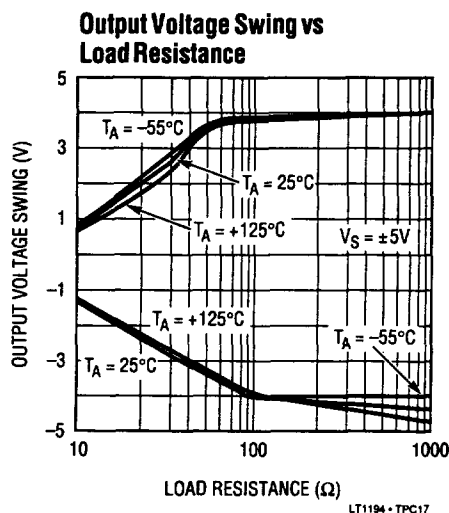
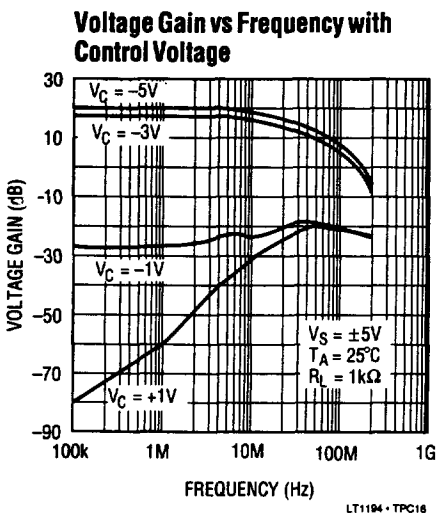
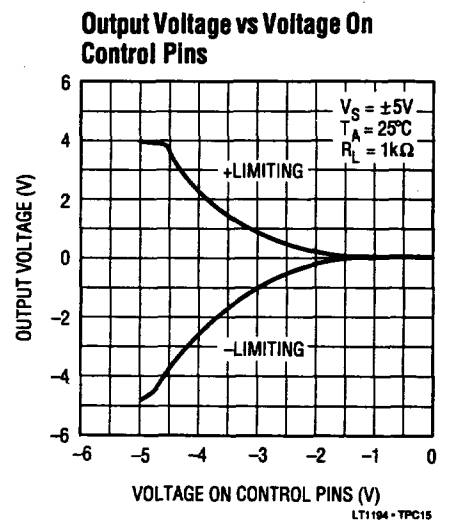
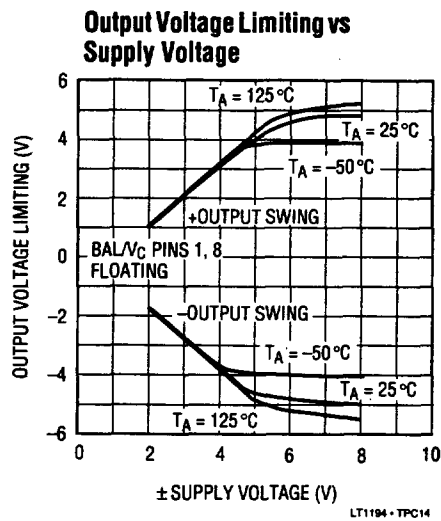
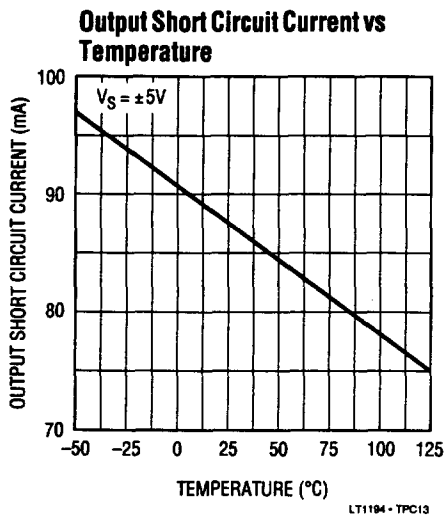
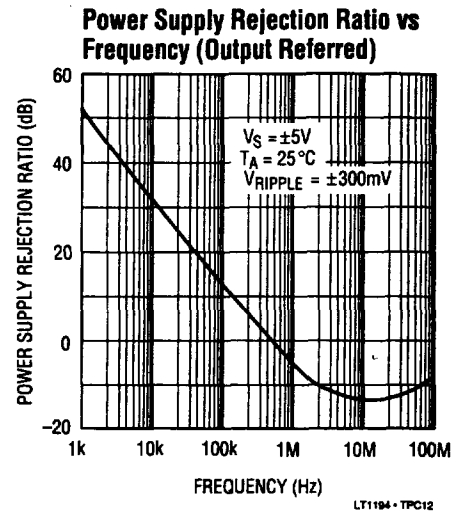
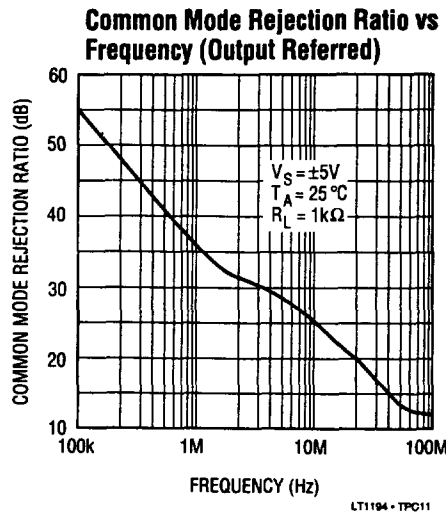
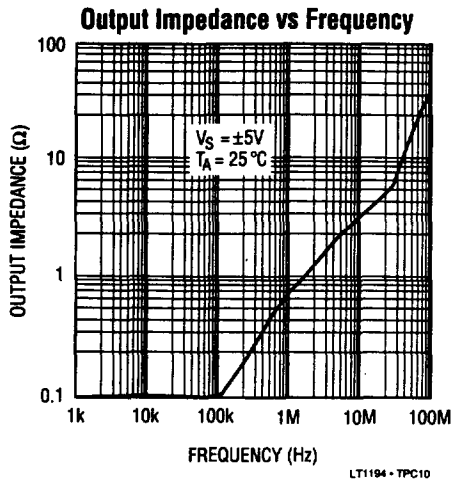

# TYPICAL PERFORMANCE CHARACTERISTICS

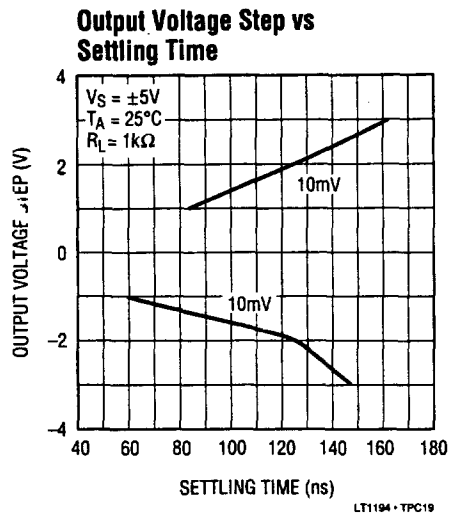

### Common Mode Rejection

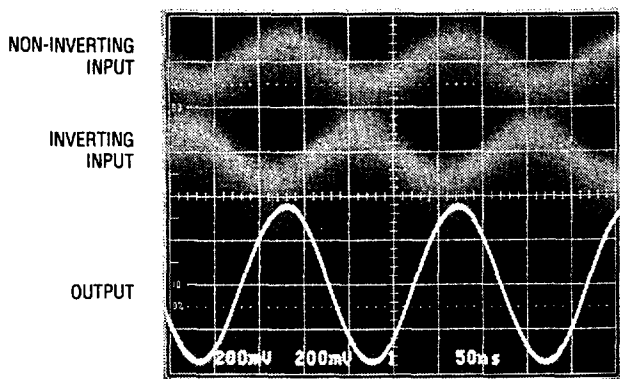

5MHz SINE WAVE RECOVERED FROM COMMON MODE NOISE

LT1194 • TPC22

2

### Small Signal Transient Response

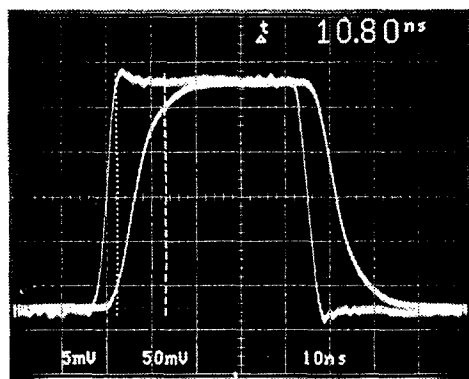

RISE TIME = 10.8ns, PROPAGATION DELAY = 6ns

LT1194 • TPC21

### Large Signal Transient Response

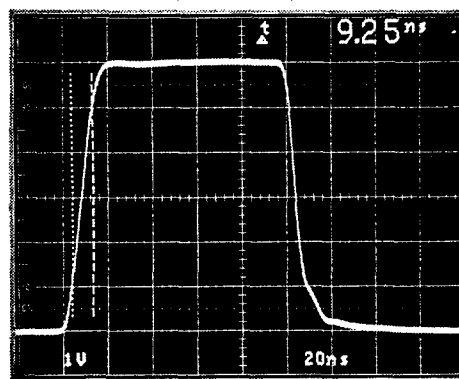

$R_L = 150\Omega$ ,  $+SR = 430V/\mu s$ ,  $-SR = 500V/\mu s$

LT1194 • TPC20

## APPLICATIONS INFORMATION

The LT1194 is a video difference amplifier with a fixed gain of 10 (20dB). The amplifier has two uncommitted high input impedance (+) and (-) inputs which can be used either differentially or single-ended. The LT1194 includes a Limiting feature which allows the amplifier to reduce its output as a function of DC voltage on the BAL/V<sub>C</sub> pins. The Limiting feature uses input differential pair limiting to prevent overload in subsequent stages. This technique allows extremely fast limiting action.

### Input Limiting

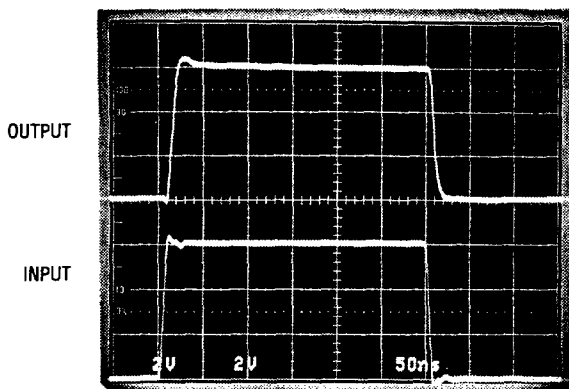

20dB INPUT OVERDRIVE V<sub>C</sub> = -4.2V

LT1194 - TA06

### Power Supply Bypassing

The LT1194 is quite tolerant of power supply bypassing. In some applications a 0.1μF ceramic disc capacitor placed 1/2 inch from the amplifier is all that is required. A scope photo of the amplifier output with no supply bypassing is used to demonstrate this bypassing tolerance, R<sub>L</sub> = 1kΩ.

### No Supply Bypass

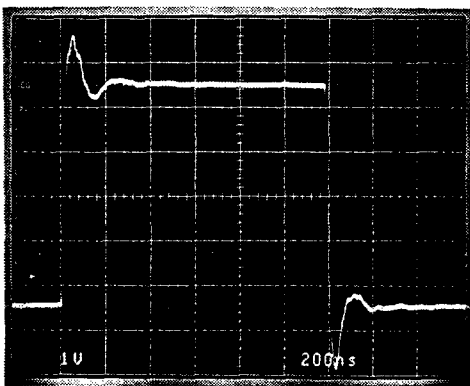

IN DEMO BOARD, R<sub>L</sub> = 1kΩ

LT1194 - TA07

In many applications, and those requiring good settling time, it is important to use multiple bypass capacitors. A 0.1μF ceramic disc in parallel with a 4.7μF tantalum is recommended. Two oscilloscope photos with different bypass conditions are used to illustrate the settling time characteristics of the amplifier. Note that although the output waveform looks acceptable at 1V/div, when amplified to 10mV/div the settling time to 10mV is 200ns. The time drops to 162ns with multiple bypass capacitors, and does not exhibit the characteristic power supply ringing.

### Settling Time Poor Bypass

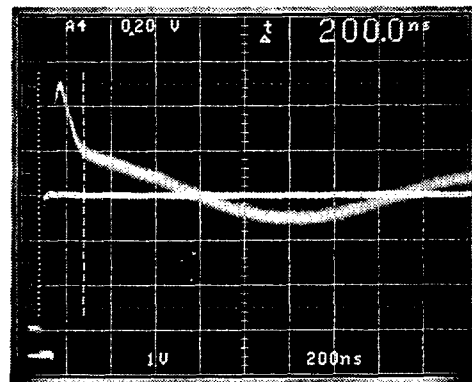

SETTLING TIME TO 10mV,  
SUPPLY BYPASS CAPACITORS = 0.1μF

LT1194 - TA08

### Settling Time Good Bypass

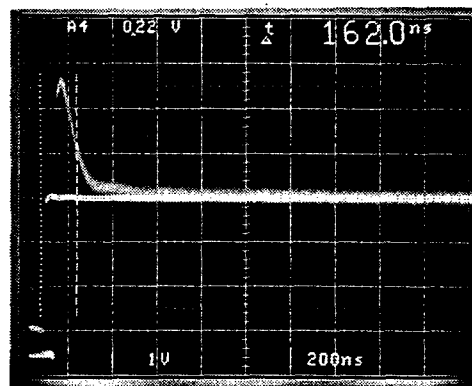

SETTLING TIME TO 10mV, SUPPLY BYPASS  
CAPACITORS = 0.1μF + 4.7μF TANTALUM

LT1194 - TA09



## APPLICATIONS INFORMATION

### Cable Terminations

The LT1194 video difference amplifier has been optimized as a low cost cable driver. The  $\pm 50\text{mA}$  guaranteed output current enables the LT1194 to easily deliver  $7.5\text{Vp-p}$  into  $100\Omega$ , while operating on  $\pm 5\text{V}$  supplies, or  $2.6\text{Vp-p}$  on a single  $5\text{V}$  supply.

When driving a cable it is important to terminate the cable to avoid unwanted reflections. This can be done in one of two ways: single termination or double termination. With single termination, the cable must be terminated at the receiving end ( $75\Omega$  to ground) to absorb unwanted energy. The best performance can be obtained by double termination ( $75\Omega$  in series with the output of the amplifier, and  $75\Omega$  to ground at the other end of the cable). This termination is preferred because reflected energy is absorbed at each end of the cable. When using the double termination technique it is important to note that the signal is attenuated by a factor of 2, or  $6\text{dB}$ . For a cable driver with a gain of  $+5$  (LT1194 gain of  $+10$ ), the  $-3\text{dB}$  bandwidth is over  $30\text{MHz}$  with no peaking.

Double Terminated Cable Driver

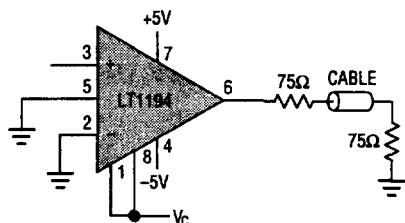

Voltage Gain vs Frequency

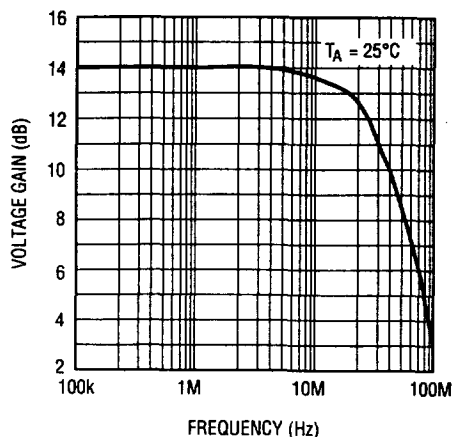

### A Voltage Controlled Current Source

The LT1194 can be used to make a fast, precise, voltage controlled current source. The LT1194 high speed differential amplifier senses the current delivered to the load. The input signal  $V_{IN}$ , applied to the (+) input of the LT1191, will appear at the (-) input if the feedback loop is properly closed. In steady state the input signal appears at the output of the LT1194, and  $1/10$  of this signal is applied across the sense resistor. Thus the output current is simply:

$$I_O = \frac{V_{IN}}{R \times 10}$$

The compensation capacitor  $C_C$  forces the LT1191 to be the dominate pole for the loop, while the LT1194 is fast enough to be transparent in the feedback path. The ratio of the load resistor to the sense resistor should be approximately  $10:1$  or greater for easy compensation. For the example shown the load resistor is  $100\Omega$ , the sense resistor is  $5.1\Omega$ , and various loop compensation capacitors cause the output to exhibit an underdamped, critically, and overdamped response.

Voltage Controlled Current Source

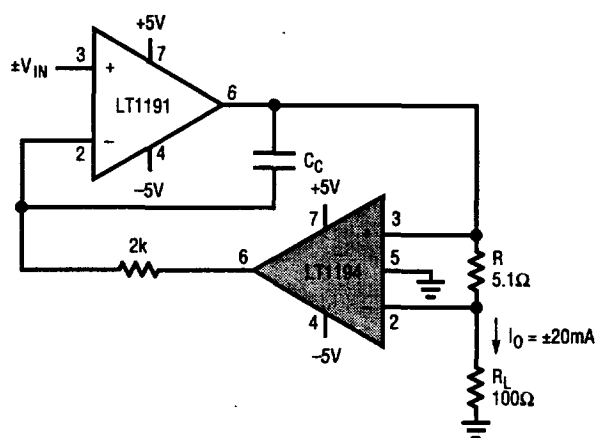

LT1194-TA15

2

## APPLICATIONS INFORMATION

### Output Current Response

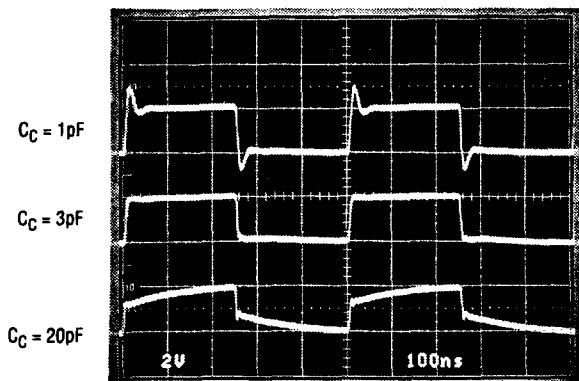

±20mA CURRENT SOURCE WITH DIFFERENT COMPENSATION CAPACITORS

LT1194 - TA16

### Differential Video Loop Thru Amplifier for Power Down Applications

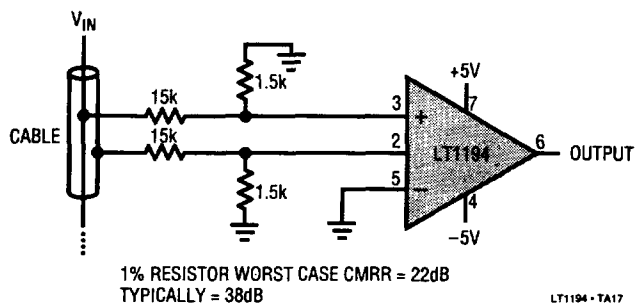

LT1194 - TA17

### Murphy Circuits

There are several precautions the user should take when using the LT1194 in order to realize its full capability. Although the LT1194 can drive a 50pF capacitive load, isolating the capacitance with 10Ω can be helpful. Precautions primarily have to do with driving large capacitive loads.

Other precautions include:

1. Use a ground plane (see Design Note 50, High Frequency Amplifier Evaluation Board).
2. Do not use high source impedances. The input capacitance of 2pF, and  $R_S = 10k\Omega$ , for instance, will give an 8MHz -3dB bandwidth.
3. PC board socket may reduce stability.

### Driving Capacitive Load

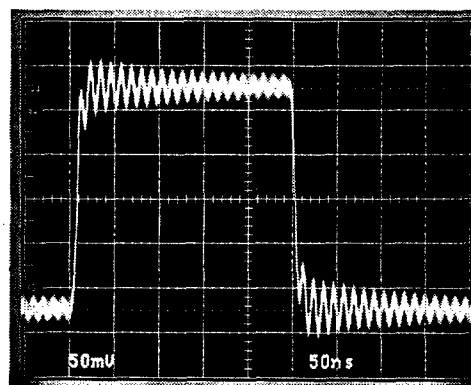

LT1194 IN DEMO BOARD,  $C_L = 50pF$

LT1194 - TA11

### Driving Capacitive Load

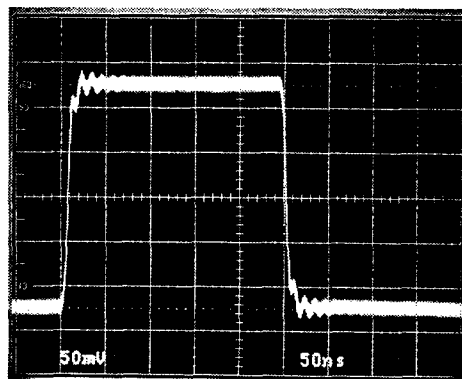

LT1194 IN DEMO BOARD,  $C_L = 50pF$  WITH 10Ω ISOLATING RESISTOR

LT1194 - TA12

# APPLICATIONS INFORMATION

## Murphy Circuits

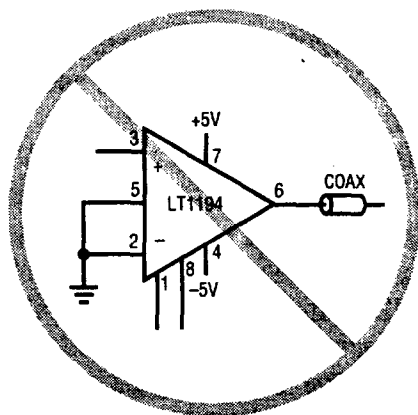

An unterminated cable is a large capacitive load

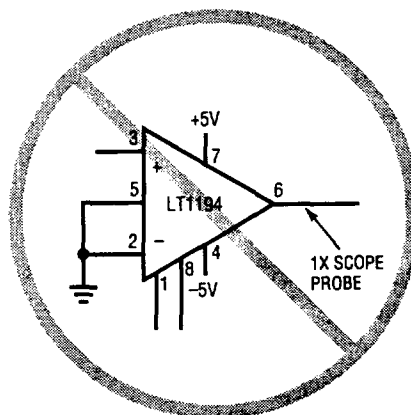

A 1X Scope Probe is a large capacitive load

LT1194-TA13

2

# SIMPLIFIED SCHEMATIC

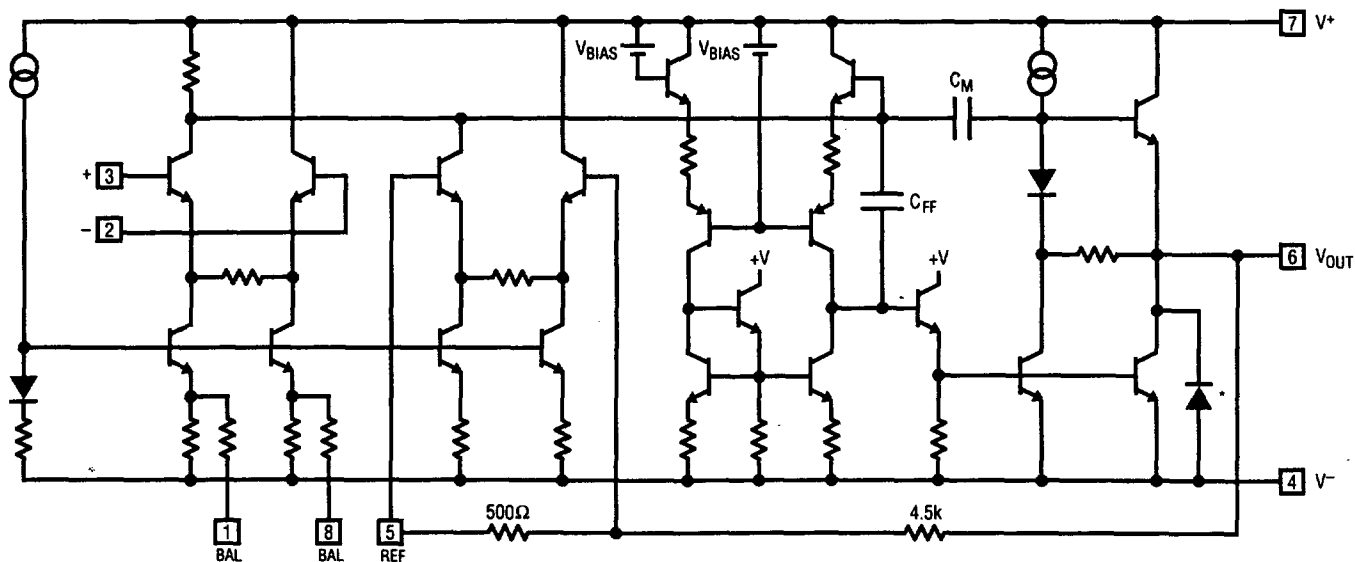

\* SUBSTRATE DIODE, DO NOT FORWARD BIAS

LT1194-TA14

**ABSOLUTE MAXIMUM RATINGS**

Total Supply Voltage ( $V^+$  to  $V^-$ ) ..... 18V  
 Differential Input Voltage .....  $\pm 6V$   
 Input Voltage .....  $\pm V_S$   
 Output Short Circuit Duration (Note 1) ..... Continuous  
 Operating Junction Temperature Range  
     LT1194M .....  $-55^\circ C$  to  $150^\circ C$   
     LT1194C .....  $0^\circ C$  to  $150^\circ C$   
 Max. Junction Temperature ..... See Pkg. Descriptions  
 Storage Temperature Range .....  $-65^\circ C$  to  $150^\circ C$   
 Lead Temperature (Soldering, 10 sec.) .....  $300^\circ C$

**PACKAGE/ORDER INFORMATION**

<p>TOP VIEW</p> <p>J8 PACKAGE 8-LEAD HERMETIC DIP    N8 PACKAGE 8-LEAD PLASTIC DIP          S8 PACKAGE 8-LEAD PLASTIC SOIC</p> <p>LT1194 - P001</p>	ORDER PART NUMBER
	LT1194MJ8 LT1194CJ8 LT1194CN8 LT1194CS8
	S8 PART MARKING
	1194

**ELECTRICAL CHARACTERISTICS**

$V_S = \pm 5V$ ,  $V_{REF} = 0V$ , Null pins 1 and 8 open circuit,  $T_A = 25^\circ C$ ,  $C_L \leq 10pF$ , unless otherwise noted.

SYMBOL	PARAMETER	CONDITIONS	LT1194M/C			UNITS
			MIN	TYP	MAX	
$V_{OS}$	Input Offset Voltage			1.0	6.0	mV
$I_{OS}$	Input Offset Current			0.2	3.0	$\mu A$
$I_B$	Input Bias Current			$\pm 0.5$	$\pm 3.5$	$\mu A$
$e_n$	Input Noise Voltage	$f_0 = 10kHz$		15		$nV/\sqrt{Hz}$
$i_n$	Input Noise Current	$f_0 = 10kHz$		4.0		$pA/\sqrt{Hz}$
$R_{IN}$	Input Resistance	Either Input		30		$k\Omega$
$C_{IN}$	Input Capacitance	Either Input		2.0		pF
	Input Voltage Range		-2.5		+3.5	V
CMRR	Common Mode Rejection Ratio	$V_{CM} = -2.5V$ to $+3.5V$	65	80		dB
PSRR	Power Supply Rejection Ratio	$V_S = \pm 2.375V$ to $\pm 8V$	65	80		dB
$V_{OMAX}$	Maximum Output Signal	$V_S = \pm 8V$ , (Note 2)	$\pm 3.9$	$\pm 4.3$		V
$V_{LIM}$	Output Voltage Limit	$V_I = \pm 0.5V$ , $V_C = +2V$ , (Note 3)		$\pm 20$	$\pm 120$	mV
$V_{OUT}$	Output Voltage Swing	$V_S = \pm 8V$ , $V_{REF} = +3V$	$R_L = 1k$	+6.6	+6.9	V
			$R_L = 100\Omega$	+6.3	+6.7	
		$V_S = \pm 8V$ , $V_{REF} = -3V$	$R_L = 1k$	-6.7	-7.4	
			$R_L = 100\Omega$	-6.4	-6.7	
		$V_S = \pm 5V$ , $V_{REF} = 0V$ , $R_L = 1k$	$\pm 3.8$	$\pm 4.0$		
$G_E$	Gain Error	$V_0 = \pm 3V$	$R_L = 1k$	0.5	3.0	%
			$R_L = 100\Omega$	0.5	3.0	
SR	Slew Rate	$V_0 = \pm 1V$ , $R_L = 1k$ , (Note 4, 8)	350	500		$V/\mu s$
FPBW	Full Power Bandwidth	$V_0 = 6Vp-p$ , (Note 5)	18.5	26.5		MHz
BW	Small Signal Bandwidth			35		MHz
$t_r$ , $t_f$	Rise Time, Fall Time	$R_L = 1k$ , $V_0 = \pm 500mV$ , 20% to 80%, (Note 8)	4.0	6.0	8.0	ns
$t_{PD}$	Propagation Delay	$R_L = 1k$ , $V_0 = \pm 125mV$ , 50% to 50%		6.5		ns
	Overshoot	$V_0 = \pm 125mV$		0		%

## ELECTRICAL CHARACTERISTICS

$V_S = \pm 5V$ ,  $V_{REF} = 0V$ , Null pins 1 and 8 open circuit,  $T_A = 25^\circ C$ ,  $C_L \leq 10pF$ , unless otherwise noted.

SYMBOL	PARAMETER	CONDITIONS	LT1194M/C			UNITS
			MIN	TYP	MAX	
$t_s$	Settling Time	3V Step, 0.1%, (Note 6)		200		ns
Diff $A_V$	Differential Gain	$R_L = 150\Omega$ , (Note 7)		0.2		%
Diff Ph	Differential Phase	$R_L = 150\Omega$ , (Note 7)		0.08		Deg p-p
$I_S$	Supply Current			35	43	mA

## ELECTRICAL CHARACTERISTICS

$V_{S+} = +5V$ ,  $V_{S-} = 0V$ ,  $V_{REF} = +2.5V$ , Null pins 1 and 8 open circuit,  $T_A = 25^\circ C$ ,  $C_L \leq 10pF$ , unless otherwise noted.

SYMBOL	PARAMETER	CONDITIONS	LT1194M/C			UNITS
			MIN	TYP	MAX	
$V_{OS}$	Input Offset Voltage			2.0	8.0	mV
$I_{OS}$	Input Offset Current			0.2	3.0	$\mu A$
$I_B$	Input Bias Current			$\pm 0.5$	$\pm 3.0$	$\mu A$
	Input Voltage Range		+2.0		+3.5	V
CMRR	Common Mode Rejection Ratio	$V_{CM} = +2.0V$ to $+3.5V$	55	70		dB
$V_{LIM}$	Output Voltage Limit	$V_i = \pm 0.5V$ , $V_C = +2V$ , (Note 3)		$\pm 20$	$\pm 120$	mV
$V_{OUT}$	Output Voltage Swing	$R_L = 100\Omega$ to Ground	$V_{OUT}$ High	3.6	3.8	V
			$V_{OUT}$ Low		0.25	
SR	Slew Rate	$V_O = +1V$ to $+3V$		250		V/ $\mu s$
BW	Small Signal Bandwidth			32		MHz
$I_S$	Supply Current			32	40	mA

2

## ELECTRICAL CHARACTERISTICS

$V_{S+} = \pm 5V$ ,  $V_{REF} = 0V$ , Null pins 1 and 8 open circuit,  $-55^\circ C \leq T_A \leq 125^\circ C$ , unless otherwise noted.

SYMBOL	PARAMETER	CONDITIONS	LT1194M			UNITS	
			MIN	TYP	MAX		
$V_{OS}$	Input Offset Voltage		●	1.0	9.0	mV	
$\Delta V_{OS}/\Delta T$	Input $V_{OS}$ Drift		●	6.0		$\mu V/^\circ C$	
$I_{OS}$	Input Offset Current		●	0.8	5.0	$\mu A$	
$I_B$	Input Bias Current		●	$\pm 1.0$	$\pm 5.5$	$\mu A$	
	Input Voltage Range		●	-2.5	+3.5	V	
CMRR	Common Mode Rejection Ratio	$V_{CM} = -2.5V$ to $+3.5V$	●	58	80	dB	
PSRR	Power Supply Rejection Ratio	$V_S = \pm 2.375V$ to $\pm 5.0V$	●	60	80	dB	
$V_{LIM}$	Output Voltage Limit	$V_i = \pm 0.5V$ , $V_C = +2V$ , (Note 3)	●	$\pm 20$	$\pm 150$	mV	
$V_{OUT}$	Output Voltage Swing	$V_S = \pm 8V$ $V_{REF} = +3V$	$R_L = 1k$	●	+6.0	+6.6	V
			$R_L = 100\Omega$	●	+5.9	+6.5	
		$V_S = \pm 8V$ $V_{REF} = -3V$	$R_L = 1k$	●	-6.1	-6.7	
			$R_L = 100\Omega$	●	-6.0	-6.5	
$G_E$	Gain Error	$V_O = \pm 3V$ , $R_L = 1k$	●	1.0	5.0	%	
$I_S$	Supply Current		●	35	43	mA	

# LT1194

## ELECTRICAL CHARACTERISTICS

$V_{S+} = \pm 5V$ ,  $V_{REF} = 0V$ , Null pins 1 and 8 open circuit,  $0^{\circ}C \leq T_A \leq 70^{\circ}C$ , unless otherwise noted.

SYMBOL	PARAMETER	CONDITIONS	LT1194C			UNITS
			MIN	TYP	MAX	
$V_{OS}$	Input Offset Voltage	●		1.0	7.0	mV
$\Delta V_{OS}/\Delta T$	Input $V_{OS}$ Drift	●		6.0		$\mu V/^{\circ}C$
$I_{OS}$	Input Offset Current					

# TYPICAL PERFORMANCE CHARACTERISTICS

2

**Input Bias Current vs Common Mode Voltage**

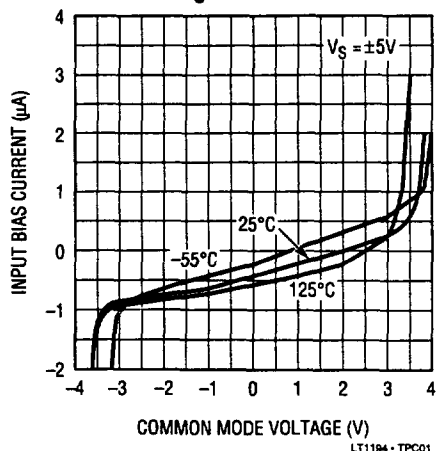

**Input Bias Current vs Temperature**

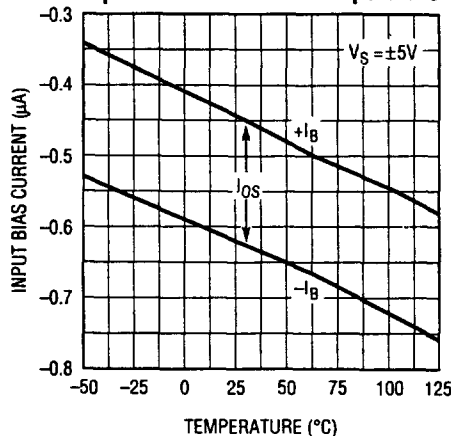

**Common Mode Voltage vs Supply Voltage**

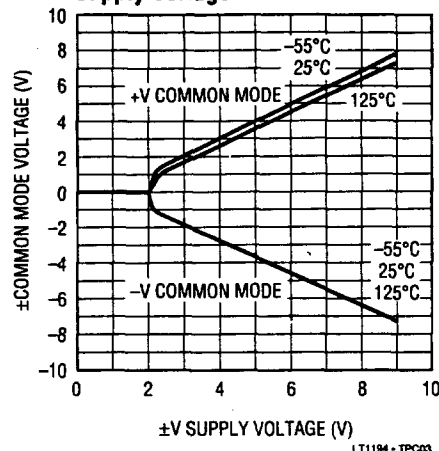

**Equivalent Input Noise Voltage vs Frequency**

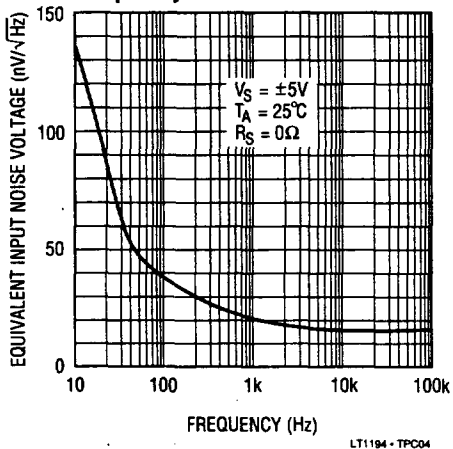

**Equivalent Input Noise Current vs Frequency**

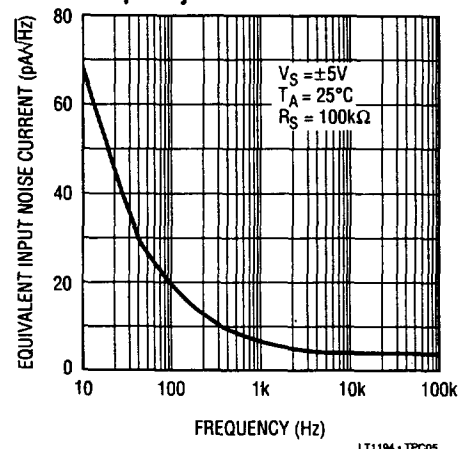

**Supply Current vs Supply Voltage**

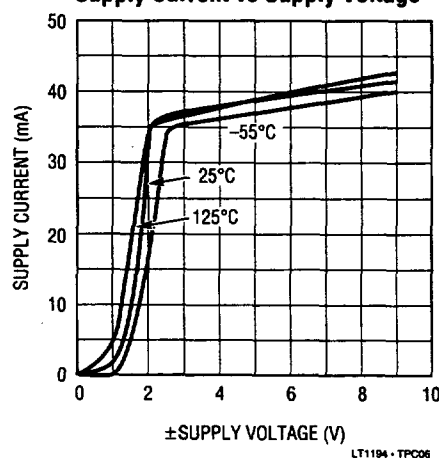

**Gain, Phase vs Frequency**

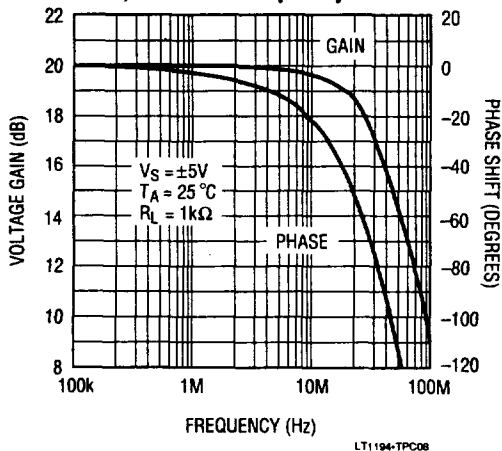

**Gain Error vs Temperature**

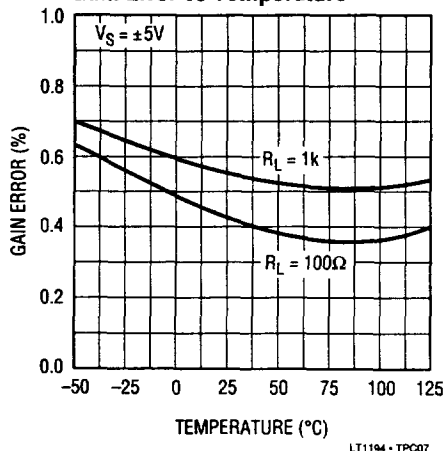

**-3dB Bandwidth vs Supply Voltage**

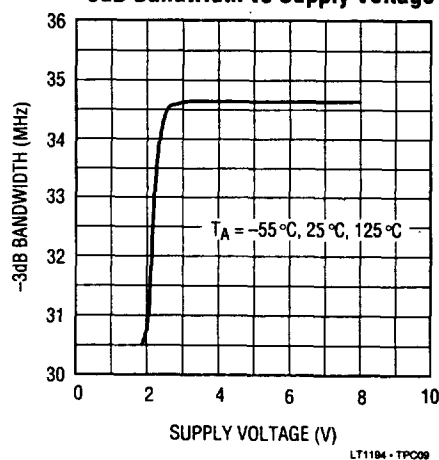

TYPICAL PERFORMANCE CHARACTERISTICS

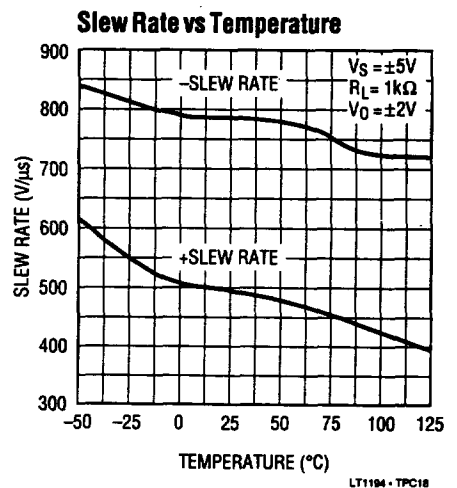
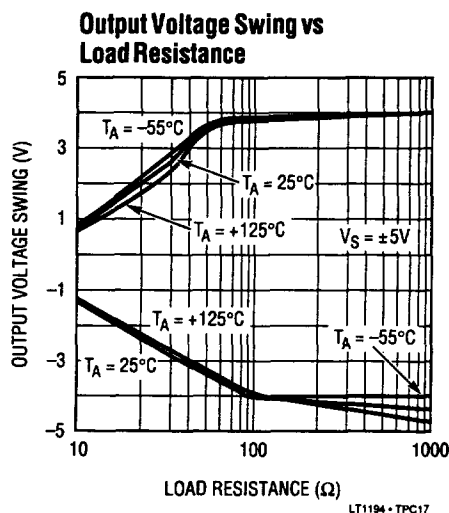
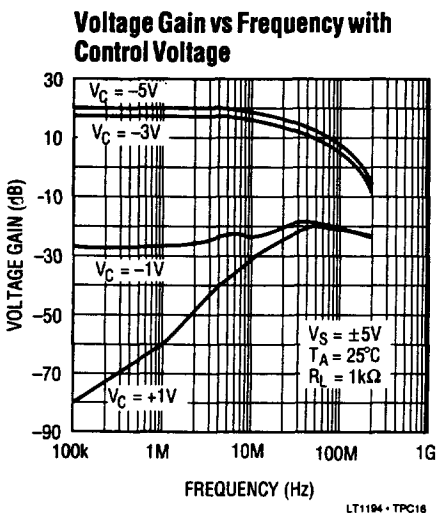
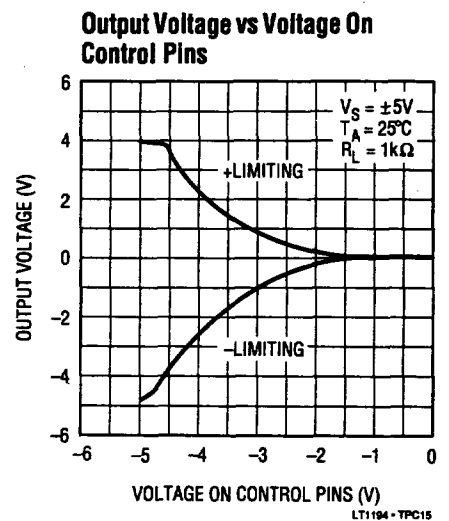
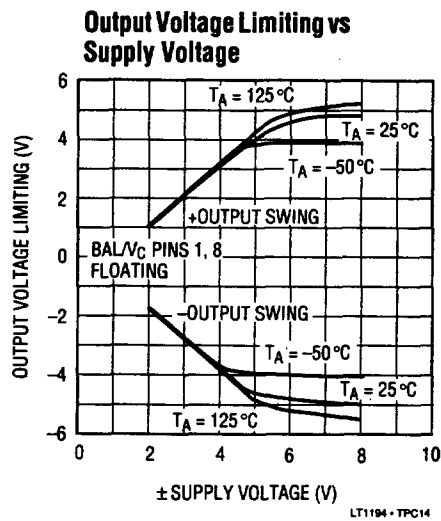
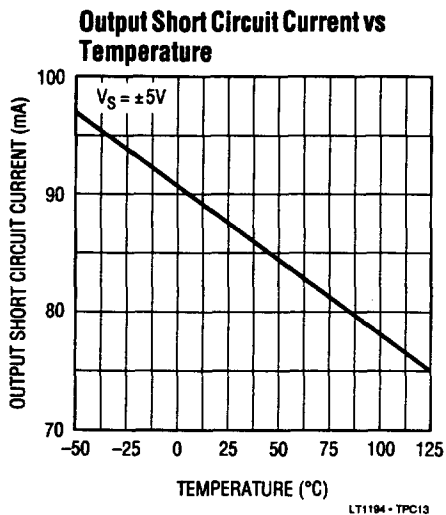
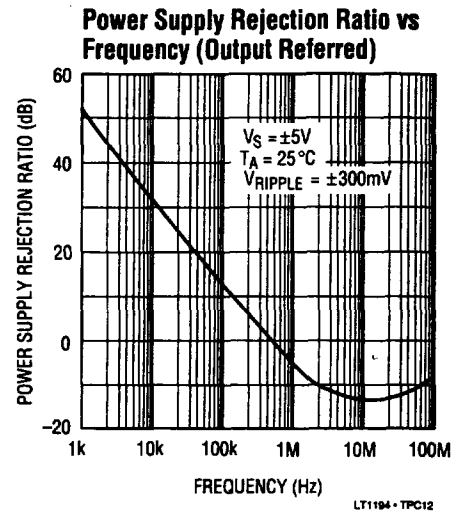
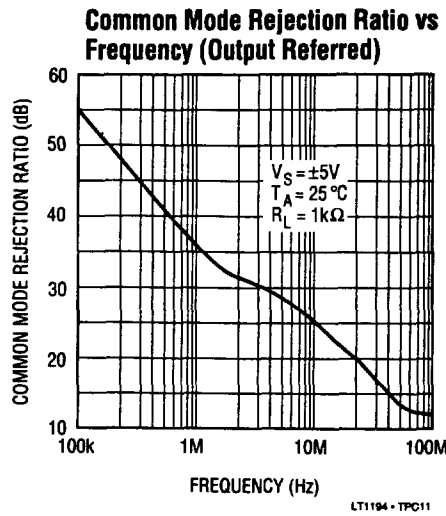
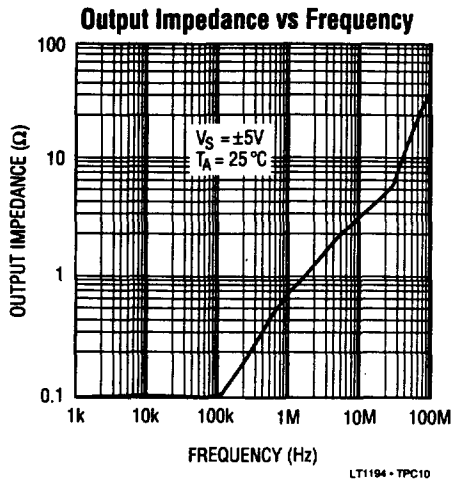



# TYPICAL PERFORMANCE CHARACTERISTICS

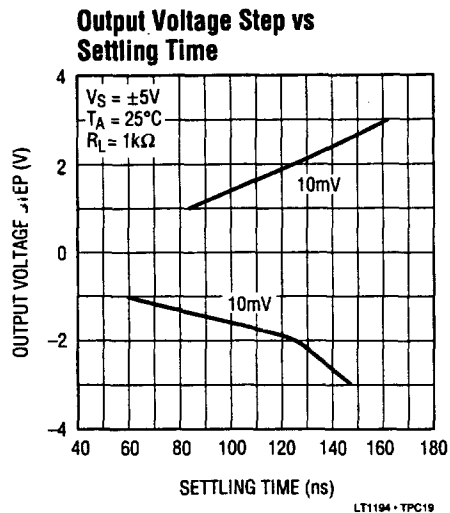

### Common Mode Rejection

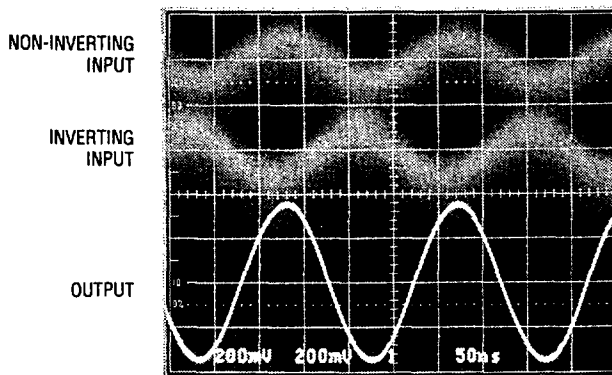

5MHz SINE WAVE RECOVERED FROM COMMON MODE NOISE

LT1194 • TPC22

2

### Small Signal Transient Response

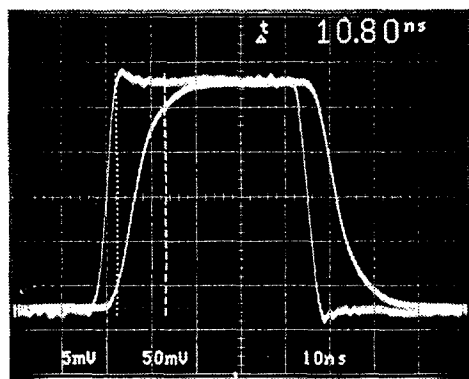

RISE TIME = 10.8ns, PROPAGATION DELAY = 6ns

LT1194 • TPC21

### Large Signal Transient Response

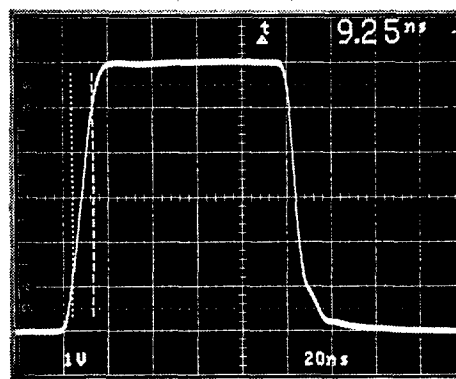

$R_L = 150\Omega$ ,  $+SR = 430V/\mu s$ ,  $-SR = 500V/\mu s$

LT1194 • TPC20

## APPLICATIONS INFORMATION

The LT1194 is a video difference amplifier with a fixed gain of 10 (20dB). The amplifier has two uncommitted high input impedance (+) and (-) inputs which can be used either differentially or single-ended. The LT1194 includes a Limiting feature which allows the amplifier to reduce its output as a function of DC voltage on the BAL/V<sub>C</sub> pins. The Limiting feature uses input differential pair limiting to prevent overload in subsequent stages. This technique allows extremely fast limiting action.

### Input Limiting

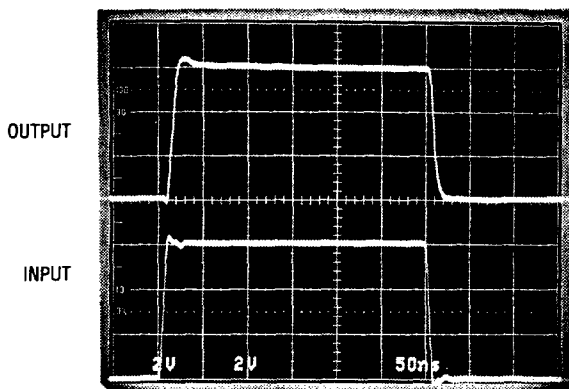

20dB INPUT OVERDRIVE V<sub>C</sub> = -4.2V

LT1194 - TA06

### Power Supply Bypassing

The LT1194 is quite tolerant of power supply bypassing. In some applications a 0.1μF ceramic disc capacitor placed 1/2 inch from the amplifier is all that is required. A scope photo of the amplifier output with no supply bypassing is used to demonstrate this bypassing tolerance, R<sub>L</sub> = 1kΩ.

### No Supply Bypass

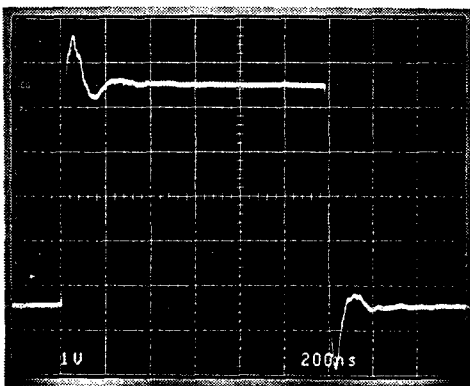

IN DEMO BOARD, R<sub>L</sub> = 1kΩ

LT1194 - TA07

In many applications, and those requiring good settling time, it is important to use multiple bypass capacitors. A 0.1μF ceramic disc in parallel with a 4.7μF tantalum is recommended. Two oscilloscope photos with different bypass conditions are used to illustrate the settling time characteristics of the amplifier. Note that although the output waveform looks acceptable at 1V/div, when amplified to 10mV/div the settling time to 10mV is 200ns. The time drops to 162ns with multiple bypass capacitors, and does not exhibit the characteristic power supply ringing.

### Settling Time Poor Bypass

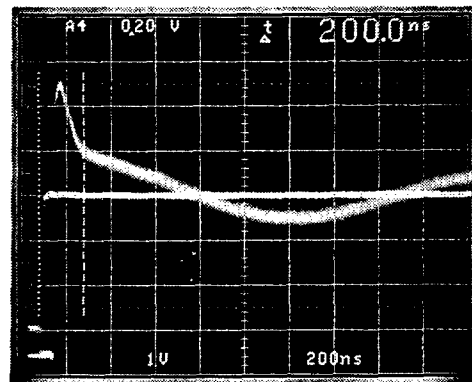

SETTLING TIME TO 10mV,  
SUPPLY BYPASS CAPACITORS = 0.1μF

LT1194 - TA08

### Settling Time Good Bypass

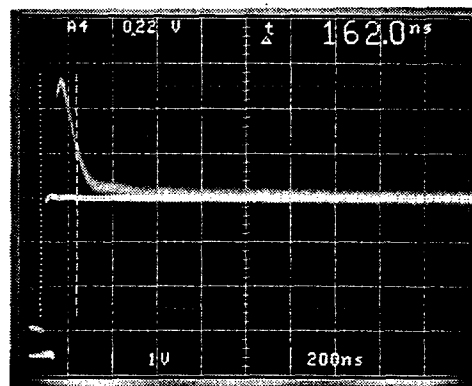

SETTLING TIME TO 10mV, SUPPLY BYPASS  
CAPACITORS = 0.1μF + 4.7μF TANTALUM

LT1194 - TA09

## APPLICATIONS INFORMATION

### Cable Terminations

The LT1194 video difference amplifier has been optimized as a low cost cable driver. The  $\pm 50\text{mA}$  guaranteed output current enables the LT1194 to easily deliver  $7.5\text{Vp-p}$  into  $100\Omega$ , while operating on  $\pm 5\text{V}$  supplies, or  $2.6\text{Vp-p}$  on a single  $5\text{V}$  supply.

When driving a cable it is important to terminate the cable to avoid unwanted reflections. This can be done in one of two ways: single termination or double termination. With single termination, the cable must be terminated at the receiving end ( $75\Omega$  to ground) to absorb unwanted energy. The best performance can be obtained by double termination ( $75\Omega$  in series with the output of the amplifier, and  $75\Omega$  to ground at the other end of the cable). This termination is preferred because reflected energy is absorbed at each end of the cable. When using the double termination technique it is important to note that the signal is attenuated by a factor of 2, or  $6\text{dB}$ . For a cable driver with a gain of  $+5$  (LT1194 gain of  $+10$ ), the  $-3\text{dB}$  bandwidth is over  $30\text{MHz}$  with no peaking.

Double Terminated Cable Driver

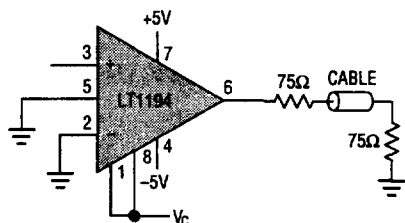

Voltage Gain vs Frequency

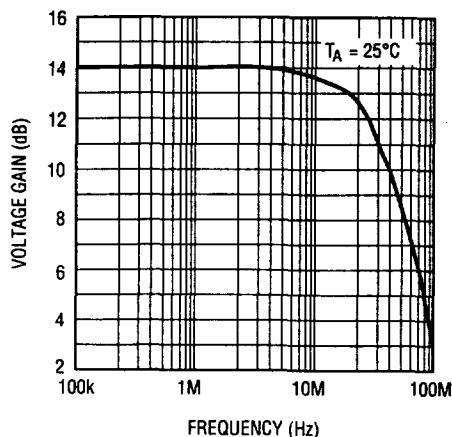

### A Voltage Controlled Current Source

The LT1194 can be used to make a fast, precise, voltage controlled current source. The LT1194 high speed differential amplifier senses the current delivered to the load. The input signal  $V_{IN}$ , applied to the (+) input of the LT1191, will appear at the (-) input if the feedback loop is properly closed. In steady state the input signal appears at the output of the LT1194, and  $1/10$  of this signal is applied across the sense resistor. Thus the output current is simply:

$$I_O = \frac{V_{IN}}{R \times 10}$$

The compensation capacitor  $C_C$  forces the LT1191 to be the dominate pole for the loop, while the LT1194 is fast enough to be transparent in the feedback path. The ratio of the load resistor to the sense resistor should be approximately  $10:1$  or greater for easy compensation. For the example shown the load resistor is  $100\Omega$ , the sense resistor is  $5.1\Omega$ , and various loop compensation capacitors cause the output to exhibit an underdamped, critically, and overdamped response.

Voltage Controlled Current Source

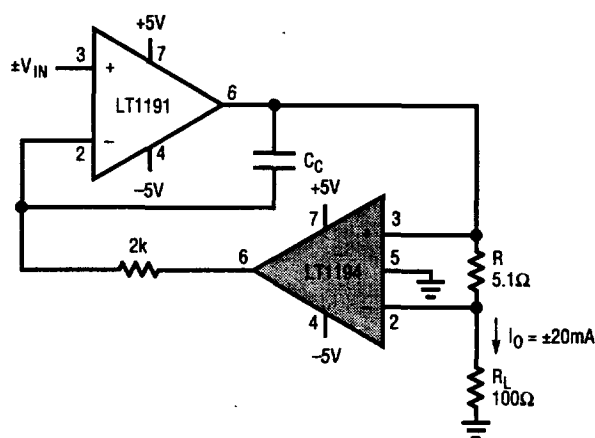

LT1194 - TA15

2

## APPLICATIONS INFORMATION

### Output Current Response

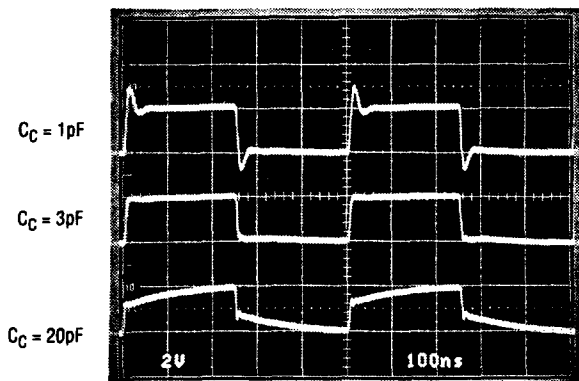

±20mA CURRENT SOURCE WITH DIFFERENT COMPENSATION CAPACITORS

LT1194 - TA16

### Differential Video Loop Thru Amplifier for Power Down Applications

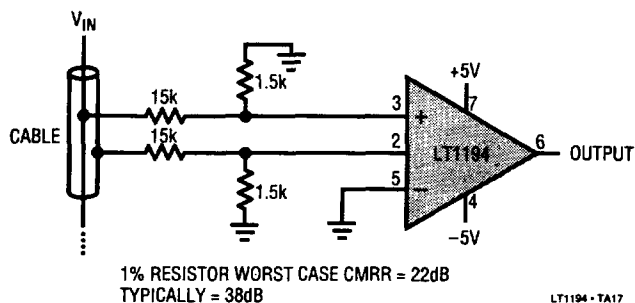

LT1194 - TA17

### Murphy Circuits

There are several precautions the user should take when using the LT1194 in order to realize its full capability. Although the LT1194 can drive a 50pF capacitive load, isolating the capacitance with 10Ω can be helpful. Precautions primarily have to do with driving large capacitive loads.

Other precautions include:

1. Use a ground plane (see Design Note 50, High Frequency Amplifier Evaluation Board).
2. Do not use high source impedances. The input capacitance of 2pF, and  $R_S = 10k\Omega$ , for instance, will give an 8MHz -3dB bandwidth.
3. PC board socket may reduce stability.

### Driving Capacitive Load

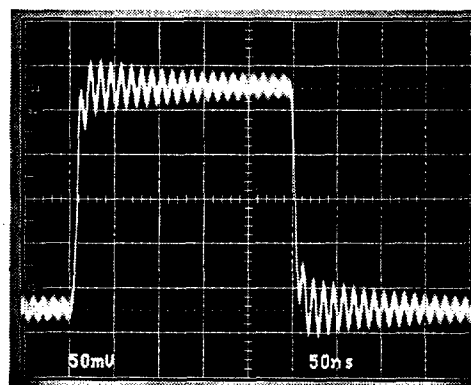

LT1194 IN DEMO BOARD,  $C_L = 50pF$

LT1194 - TA11

### Driving Capacitive Load

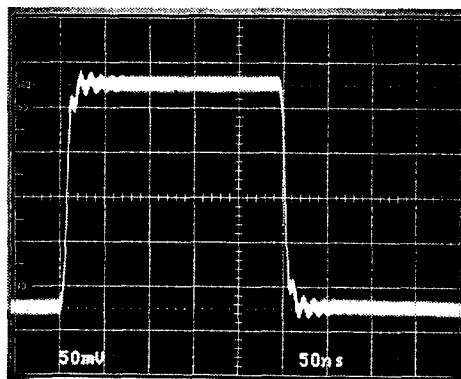

LT1194 IN DEMO BOARD,  $C_L = 50pF$  WITH 10Ω ISOLATING RESISTOR

LT1194 - TA12

# APPLICATIONS INFORMATION

## Murphy Circuits

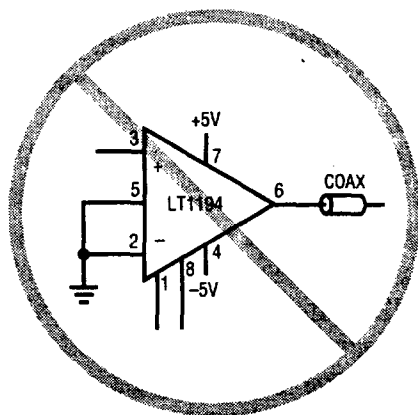

An unterminated cable is a large capacitive load

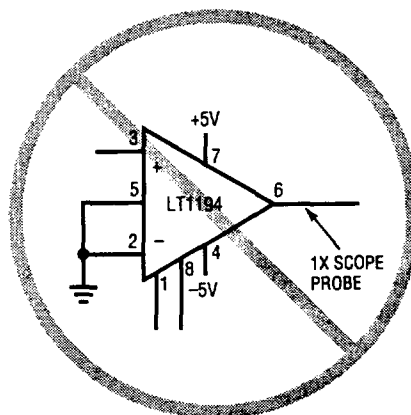

A 1X scope probe is a large capacitive load

LT1194-TA13

2

# SIMPLIFIED SCHEMATIC

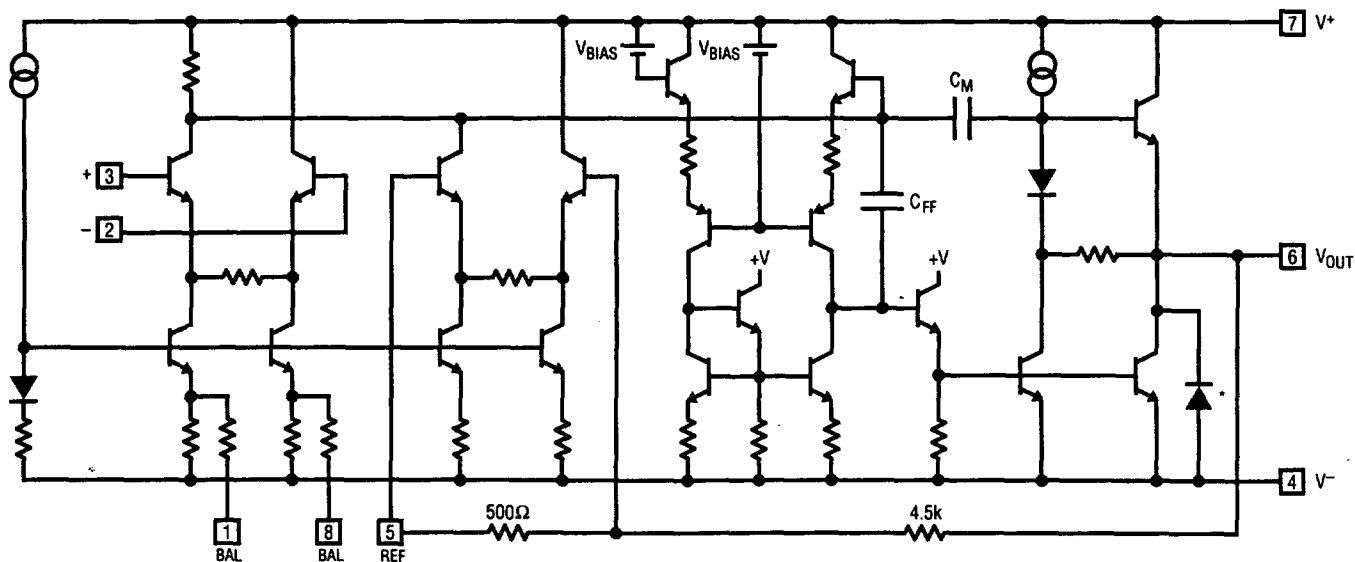

\* SUBSTRATE DIODE, DO NOT FORWARD BIAS

LT1194-TA14