

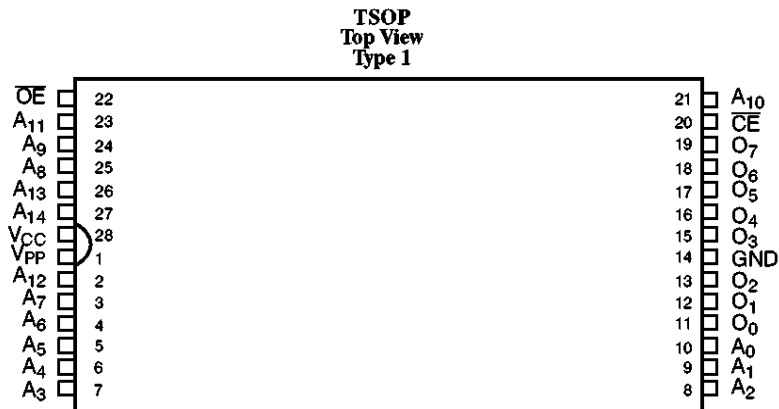

Pin Configurations (continued)



H256-4

Selection Guide

		27H256-25	27H256-30	27H256-35	27H256-45	27H256-55	27H256-70
Maximum Access Time (ns)		25	30	35	45	55	70
\overline{CE} Access Time (ns)	Com'l	30	35	35	45	55	70
	Mil			40	45	55	70
\overline{OE} Access Time (ns)	Com'l	12	15	15	15	20	25
	Mil			20	20	20	25
$I_{CC}^{[2]}$ (mA) Power Supply Current	Com'l	75	75	50	50	50	50
	Mil			85	60	60	60
$I_{SB}^{[3]}$ (mA) Stand-by Current	Com'l	15	15	15	15	15	15
	Mil			25	25	25	25

Maximum Ratings

(Above which the useful life may be impaired. For user guidelines, not tested.)

- Storage Temperature -65°C to $+150^{\circ}\text{C}$
- Ambient Temperature with Power Applied -55°C to $+125^{\circ}\text{C}$
- Supply Voltage to Ground Potential -0.5V to $+7.0\text{V}$
- DC Voltage Applied to Outputs in High Z State -0.5V to $+5.5\text{V}$
- DC Input Voltage -3.0V to $+7.0\text{V}$
- Transient Input Voltage -3.0V for $< 20\text{ ns}$
- DC Program Voltage 13.0V

Notes:

- 2. $V_{CC} = \text{Max.}, I_{OUT} = 0\text{ mA}, f = 10\text{ MHz}$.
- 3. $V_{CC} = \text{Max.}, \overline{CE} = V_{IH}$.

- UV Erasure 7258 Wsec/cm^2
- Static Discharge Voltage $>2001\text{V}$
(per MIL-STD-883, Method 3015)
- Latch-Up Current $>200\text{ mA}$

Operating Range

Range	Ambient Temperature	V_{CC}
Commercial	0°C to $+70^{\circ}\text{C}$	$5\text{V} \pm 10\%$
Industrial ^[4]	-40°C to $+85^{\circ}\text{C}$	$5\text{V} \pm 10\%$
Military ^[5]	-55°C to $+125^{\circ}\text{C}$	$5\text{V} \pm 10\%$

- 4. Contact a Cypress representative for industrial temperature range specification.
- 5. T_A is the "instant on" case temperature.



Electrical Characteristics Over the Operating Range^[6, 7]

Parameter	Description	Test Conditions	27H256-25 27H256-30		27H256-35		27H256-45 27H256-55 27H256-70		Unit
			Min.	Max.	Min.	Max.	Min.	Max.	
V _{OH}	Output HIGH Voltage	V _{CC} = Min., I _{OH} = - 4.0 mA	2.4		2.4		2.4		V
V _{OL}	Output LOW Voltage	V _{CC} = Min., I _{OL} = 12.0 mA		0.45		0.45		0.45	V
V _{IH}	Input HIGH Level	Guaranteed Input Logical HIGH Voltage for All Inputs	2.0	V _{CC} +0.5	2.0	V _{CC} +0.5	2.0	V _{CC} +0.5	V
V _{IL}	Input LOW Level	Guaranteed Input Logical LOW Voltage for All Inputs		0.8		0.8		0.8	V
I _{Ix}	Input Leakage Current	GND ≤ V _{IN} ≤ V _{CC}	- 10	+ 10	- 10	+ 10	- 10	+ 10	μA
I _{OZ}	Output Leakage Current	GND ≤ V _{OUT} ≤ V _{CC} , Output Disable	- 10	+ 10	- 10	+ 10	- 10	+ 10	μA
I _{CC}	Power Supply Current	V _{CC} =Max., I _{OUT} =0 mA, f=10 MHz	Com'l	75		50		50	mA
			Mil				85		60
I _{SB}	Stand-By Current	V _{CC} =Max., CE = V _{IH}	Com'l	15		15		15	mA
			Mil				25		25

Capacitance^[7]

Parameter	Description	Test Conditions	Max.	Unit
C _{IN}	Input Capacitance	T _A = 25°C, f = 1 MHz, V _{CC} = 5.0V	10	pF
C _{OUT}	Output Capacitance		10	pF

Notes:

- See the last page of this specification for Group A subgroup testing information.
- See Introduction to CMOS PROMs in this Data Book for general information on testing.

AC Test Loads and Waveforms

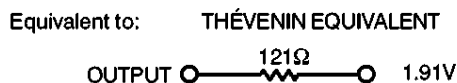
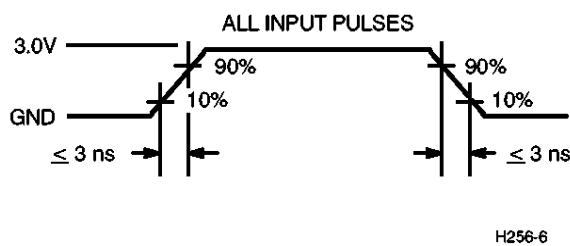
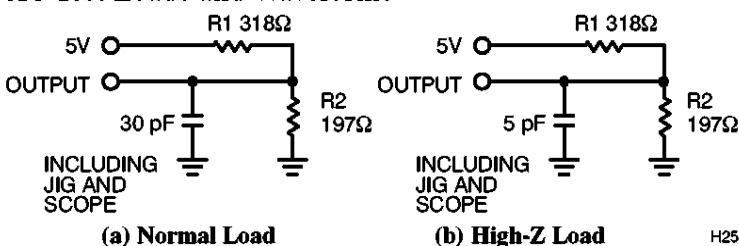



Switching Characteristics Over the Operating Range

Parameter	Description	27H256-25		27H256-30		27H256-35		27H256-45		27H256-55		27H256-70		Unit
		Min.	Max.	Min.	Max.	Min.	Max.	Min.	Max.	Min.	Max.	Min.	Max.	
t _{AA}	Address to Output Valid		25		30		35		45		55		70	ns
t _{OE}	\overline{OE} Active to Output Valid		12		15		15		15		20		25	ns
t _{HZOE}	\overline{OE} Inactive to High Z		12		15		15		15		20		25	ns
t _{CE}	\overline{CE} Active to Output Valid		30		35		35		45		55		70	ns
t _{HZCE}	\overline{CE} Inactive to High Z		12		15		15		15		20		25	ns
t _{PU}	\overline{CE} Active to Power-Up	0		0		0		0		0		0		ns
t _{PD}	\overline{CE} Inactive to Power-Down		30		35		40		40		50		60	ns
t _{OH}	Output Data Hold	0		0		0		0		0		0		ns

Switching Waveform

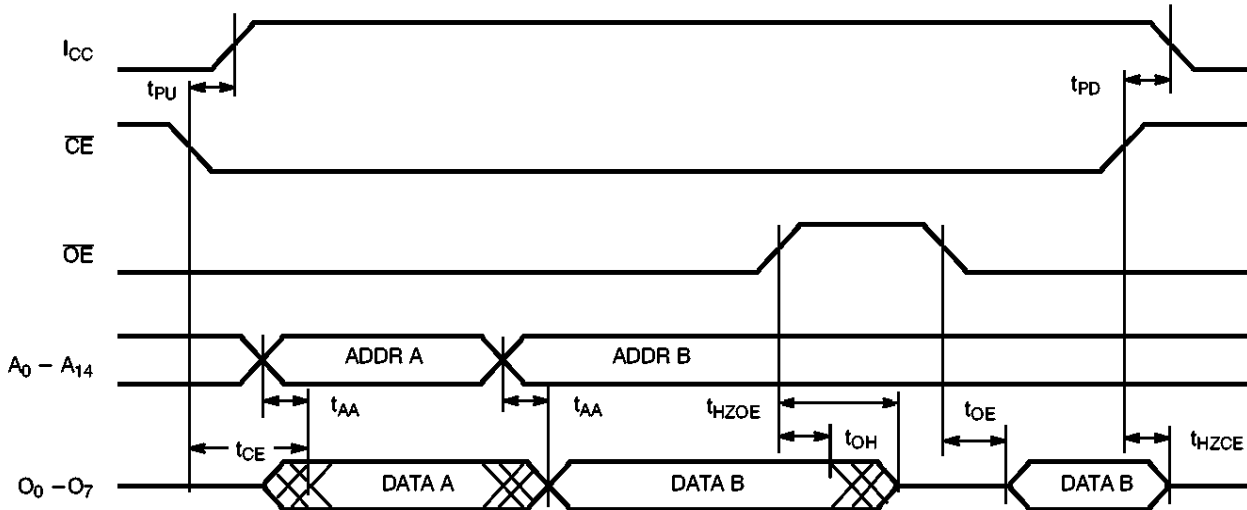

H256-7



Erasure Characteristics

Wavelengths of light less than 4000 Angstroms begin to erase the CY27H256 in the windowed package. For this reason, an opaque label should be placed over the window if the EPROM is exposed to sunlight or fluorescent lighting for extended periods of time.

The recommended dose of ultraviolet light for erasure is a wavelength of 2537 Angstroms for a minimum dose (UV intensity multiplied by exposure time) of 25 Wsec/cm². For an ultraviolet lamp with a 12 mW/cm² power rating, the exposure time would be approximately 35 minutes. The CY27H256 needs to be within 1 inch of the lamp during erasure. Permanent damage may result if the

EPROM is exposed to high-intensity UV light for an extended period of time. 7258 Wsec/cm² is the recommended maximum dosage.

Programming Modes

Programming support is available from Cypress as well as from a number of third-party software vendors. For detailed programming information, including a listing of software packages, please see the PROM Programming Information located at the end of this section. Programming algorithms can be obtained from any Cypress representative.

Table 1. Programming Electrical Characteristics

Parameter	Description	Min.	Max.	Unit
V _{PP}	Programming Power Supply	12.5	13	V
I _{PP}	Programming Supply Current		50	mA
V _{IHP}	Programming Input Voltage HIGH	3.0	V _{CC}	V
V _{ILP}	Programming Input Voltage LOW	-0.5	0.4	V
V _{CCP}	Programming V _{CC}	6.0	6.5	V

Table 2. Mode Selection

Mode	Pin Function ^[8]					
	CE	OE	V _{PP}	A ₀	A ₉	Data
Read	V _{IL}	V _{IL}	V _{IH}	A ₀	A ₉	O ₇ - O ₀
Output Disable	V _{IL}	V _{IH}	V _{IH}	A ₀	A ₉	High Z
Stand-by	V _{IH}	X	V _{IH}	X	X	High Z
Program	V _{ILP}	V _{IHP}	V _{PP}	A ₀	A ₉	D ₇ - D ₀
Program Verify	V _{IHP}	V _{ILP}	V _{PP}	A ₀	A ₉	O ₇ - O ₀
Program Inhibit	V _{IHP}	V _{IHP}	V _{PP}	A ₀	A ₉	High Z
Signature Read (MFG)	V _{IL}	V _{IL}	V _{IH}	V _{IL}	V _{HV} ^[9]	34H
Signature Read (DEV)	V _{IL}	V _{IL}	V _{IH}	V _{IH}	V _{HV} ^[9]	21H

Notes:

8. X can be V_{IL} or V_{IH}.

9. V_{HV}=12±0.5V



Typical DC and AC Characteristics

NORMALIZED SUPPLY CURRENT vs. CYCLE PERIOD

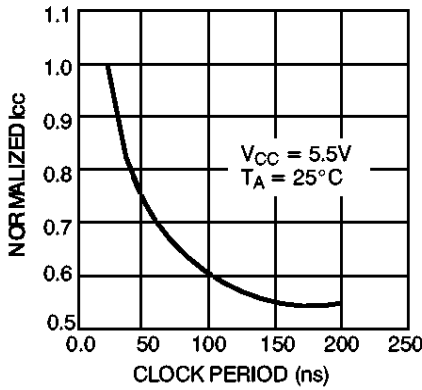

NORMALIZED SUPPLY CURRENT vs. SUPPLY VOLTAGE

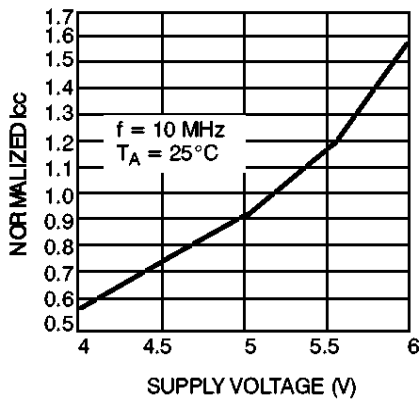

OUTPUT SOURCE CURRENT vs. OUTPUT VOLTAGE

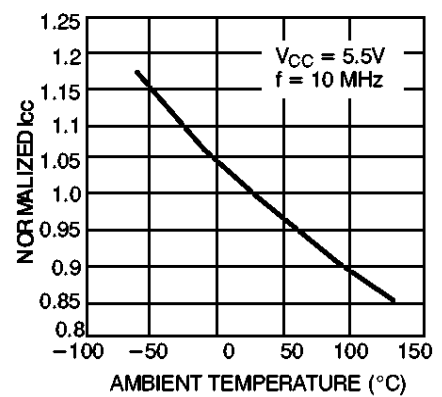

NORMALIZED ACCESS TIME vs. SUPPLY VOLTAGE

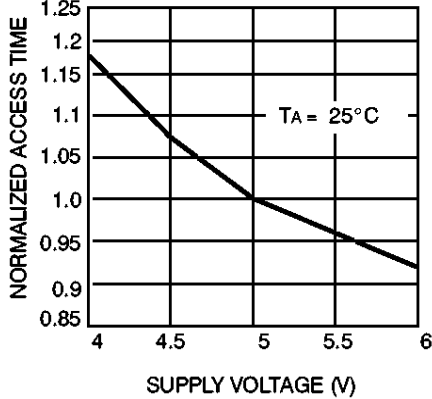

NORMALIZED ACCESS TIME vs. AMBIENT TEMPERATURE

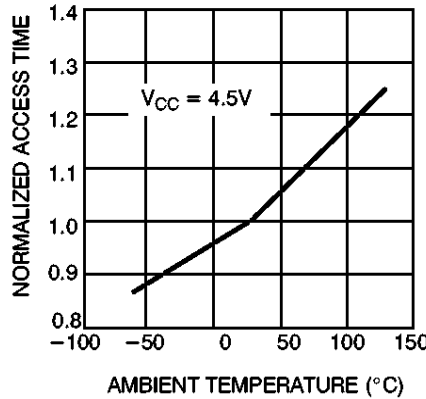

OUTPUT SINK CURRENT vs. OUTPUT VOLTAGE

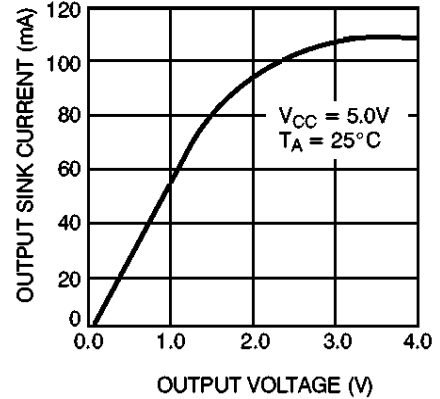

OUTPUT SOURCE CURRENT vs. OUTPUT VOLTAGE

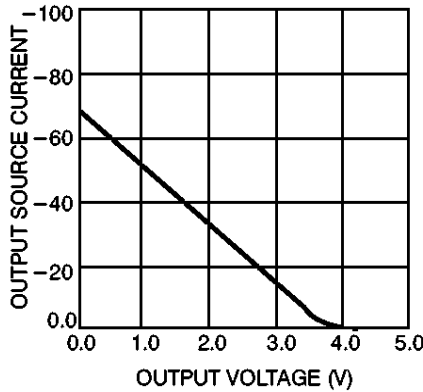



Ordering Information^[10]

Speed (ns)	Ordering Code	Package Name	Package Type	Operating Range
25	CY27H256-25JC	J65	32-Lead Plastic Leaded Chip Carrier	Commercial
	CY27H256-25ZC	Z28	28-Lead Thin Small Outline Package	
30	CY27H256-30JC	J65	32-Lead Plastic Leaded Chip Carrier	Commercial
	CY27H256-30PC	P15	28-Lead (600-Mil) Molded DIP	
	CY27H256-30WC	W16	28-Lead (600-Mil) Windowed CerDIP	
	CY27H256-30ZC	Z28	28-Lead Thin Small Outline Package	
35	CY27H256-35JC	J65	32-Lead Plastic Leaded Chip Carrier	Commercial
	CY27H256-35PC	P15	28-Lead (600-Mil) Molded DIP	
	CY27H256-35WC	W16	28-Lead (600-Mil) Windowed CerDIP	
	CY27H256-35ZC	Z28	28-Lead Thin Small Outline Package	
	CY27H256-35LMB	L55	32-Pin Rectangular Leadless Chip Carrier	Military
	CY27H256-35QMB	Q55	32-Pin Windowed Rectangular Leadless Chip Carrier	
45	CY27H256-45JC	J65	32-Lead Plastic Leaded Chip Carrier	Commercial
	CY27H256-45PC	P15	28-Lead (600-Mil) Molded DIP	
	CY27H256-45WC	W16	28-Lead (600-Mil) Windowed CerDIP	
	CY27H256-45ZC	Z28	28-Lead Thin Small Outline Package	
	CY27H256-45DMB	D16	28-Lead (600-Mil) CerDIP	Military
	CY27H256-45LMB	L55	32-Pin Rectangular Leadless Chip Carrier	
	CY27H256-45QMB	Q55	32-Pin Windowed Rectangular Leadless Chip Carrier	
	CY27H256-45WMB	W16	28-Lead (600-Mil) Windowed CerDIP	
55	CY27H256-55JC	J65	32-Lead Plastic Leaded Chip Carrier	Commercial
	CY27H256-55PC	P15	28-Lead (600-Mil) Molded DIP	
	CY27H256-55WC	W16	28-Lead (600-Mil) Windowed CerDIP	
	CY27H256-55ZC	Z28	28-Lead Thin Small Outline Package	
	CY27H256-55DMB	D16	28-Lead (600-Mil) CerDIP	Military
	CY27H256-55LMB	L55	32-Pin Rectangular Leadless Chip Carrier	
	CY27H256-55QMB	Q55	32-Pin Windowed Rectangular Leadless Chip Carrier	
	CY27H256-55WMB	W16	28-Lead (600-Mil) Windowed CerDIP	
70	CY27H256-70JC	J65	32-Lead Plastic Leaded Chip Carrier	Commercial
	CY27H256-70PC	P15	28-Lead (600-Mil) Molded DIP	
	CY27H256-70WC	W16	28-Lead (600-Mil) Windowed CerDIP	
	CY27H256-70ZC	Z28	28-Lead Thin Small Outline Package	
	CY27H256-70DMB	D16	28-Lead (600-Mil) CerDIP	Military
	CY27H256-70LMB	L55	32-Pin Rectangular Leadless Chip Carrier	
	CY27H256-70QMB	Q55	32-Pin Windowed Rectangular Leadless Chip Carrier	
	CY27H256-70WMB	W16	28-Lead (600-Mil) Windowed CerDIP	

Note:

10. Most of the above products are available in industrial temperature range. Contact a Cypress representative for specifications and product availability.



MILITARY SPECIFICATIONS
Group A Subgroup Testing

DC Characteristics

Parameter	Subgroups
V _{OH}	1, 2, 3
V _{OL}	1, 2, 3
V _{IH}	1, 2, 3
V _{IL}	1, 2, 3
I _{IX}	1, 2, 3
I _{OZ}	1, 2, 3
I _{CC}	1, 2, 3
I _{SB}	1, 2, 3

Switching Characteristics

Parameter	Subgroups
t _{AA}	7, 8, 9, 10, 11
t _{OE}	7, 8, 9, 10, 11
t _{CE}	7, 8, 9, 10, 11

Document #: 38-00423



Package Diagrams

28-Lead (600-Mil) CerDIP D16
 MIL-STD-1835 D-10 Config. A

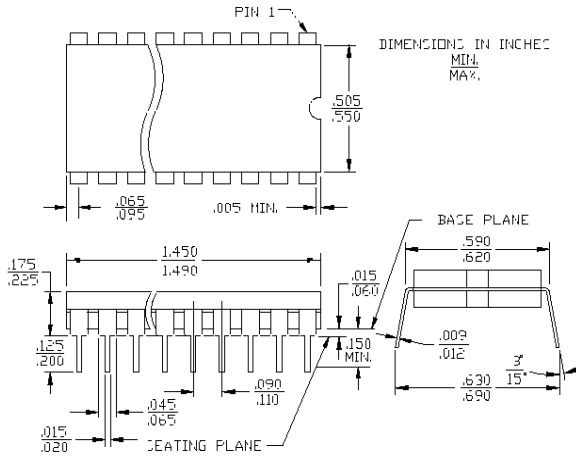

32-Lead Plastic Leaded Chip Carrier J65

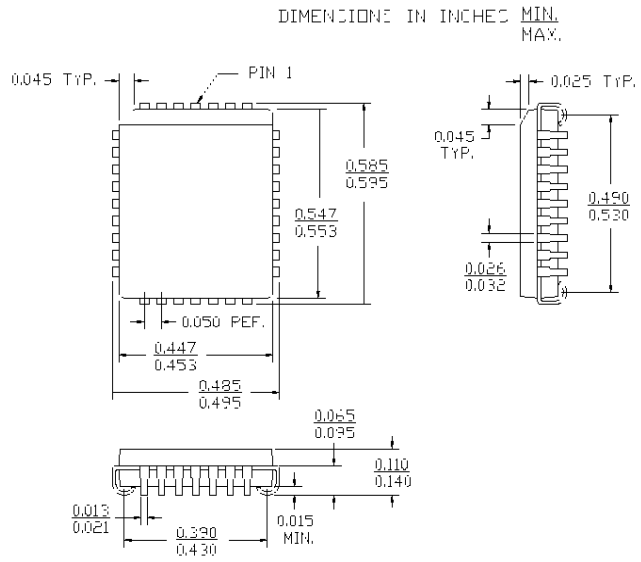

32-Pin Rectangular Leadless Chip Carrier L55
 MIL-STD-1835 C-12

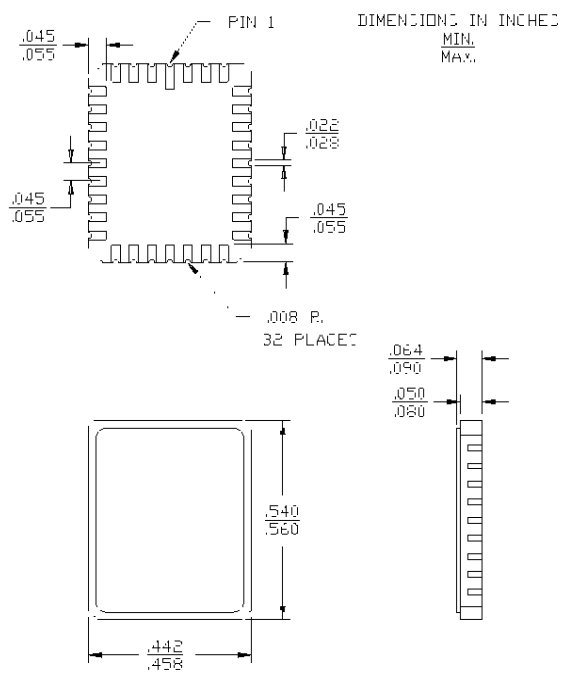

32-Pin Windowed Rectangular Leadless Chip Carrier Q55
 MIL-STD-1835 C-12

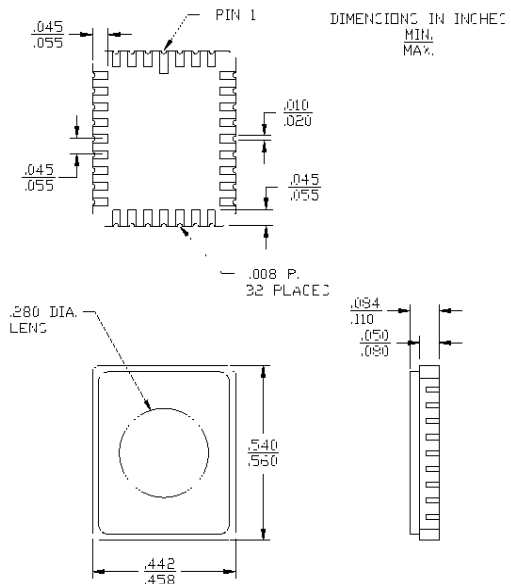



Package Diagrams (continued)

28-Lead (600-Mil) Molded DIP P15

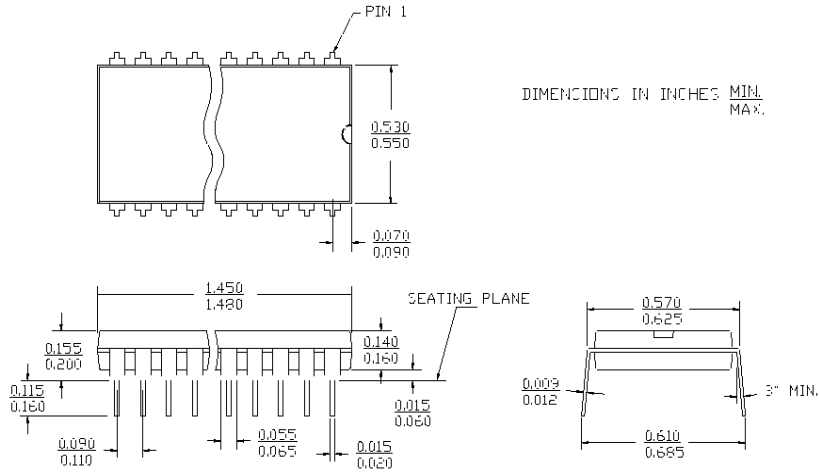

28-Lead (600-Mil) Windowed CerDIP W16
 MIL-STD-1835 D-10 Config. A

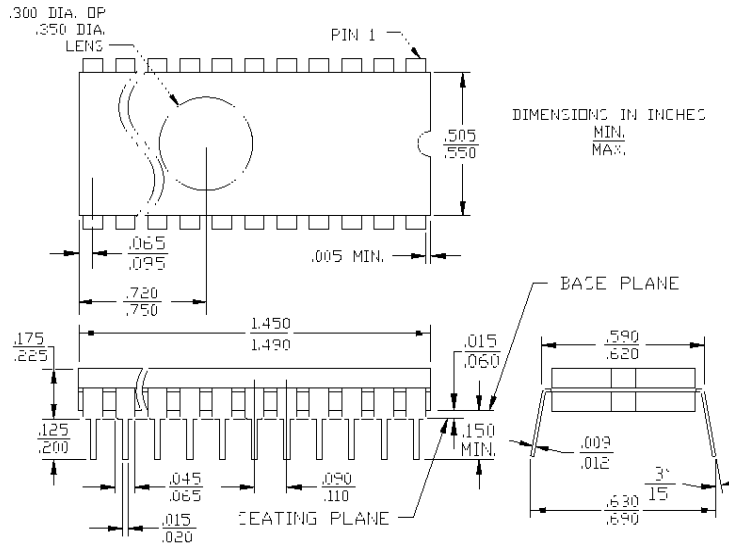



Package Diagrams (continued)

28-Lead Thin Small Outline Package Z28

DIMENSION IN MM (INCH)
 MAX.
 MIN.

