

ITT Cannon is the foremost manufacturer of MS and MS type connectors with the widest range of connector styles, sizes and variations in the industry. These connectors utilize the finest materials, which, along with precision manufacturing and rigid quality control, assure ITT Cannon customers of the finest quality connectors.

These circular connectors were originally designed for aircraft, but are now widely used in many other fields. They are particularly suitable for commercial applications requiring low cost and high reliability.

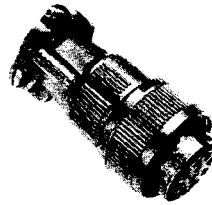
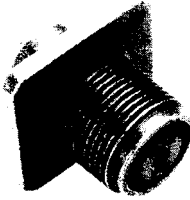

**ENVIRONMENTAL RESISTANT MS-E, MS-F, MS-R AND F80 (Solder/Crimp Termination)**

MS-E, MS-F and MS-R are similar to MS-A and MS-B connectors but have resilient insulators and wire sealing grommets for extreme environmental conditions and high altitude sealing. MS-E's and MS-F's have a mechanical cable clamp; the MS-R has a shorter, lighter weight endbell without the cable clamp. Both the MS-F and MS-R have O rings to supplement the interfacial seal. Shells are aluminum alloy. Contacts are silver plated copper alloy. The F80 modification (crimp contact termination) is available in E, R, F and BFR styles with resilient insulators.

**POTTING ER CONNECTORS (Solder Contact Termination)**

These lightweight potting connectors provide resistance to salt water, fuels, etc., and will withstand the effects of high vibration. 3100 and 3106 connectors with plastic potting cups and resilient inserts meet the requirements of MS3103 and MS25183. Contacts are silver plated copper or brass. ER insulators are resilient; shells are aluminum alloy. A 90° plug (3108ER) is also available.



**ACCESSORIES**

Accessories to fit MS connectors include junction shells, protective caps, dummy or stowage receptacles, cable clamps, telescoping bushings.

**How to Order**

In the latest revision of MIL-C-5015, a new class of environment-resistant connectors was added. This new class F connector supersedes the previous class E connector. The MS3106F is identical to the MS3106E except that the MS3106F has an "O" ring under the coupling nut. The class E will still be available upon request for existing programs, and upon ordering will also bear the E nomenclature on the shell.

MS-F and MS-R connectors are designed to operate in the extreme environmental conditions of high altitude flight and must be completely sealed to withstand moisture, condensation, vibration, corona and flashover caused by high altitude environments. They have resilient grommet with internal restrictions in the wire cavities which act as O rings around the wires. This allows the wires to slide thru the grommet with a minimum of friction, yet when the ferrule is seated and the endbell tightened it provides a perfect wire seal thru a wide variety of wire diameters. This seal at the rear, plus the interfacial seal at the front, effects a completely environment-resistant assembly when the plug is mated to an F or R receptacle. Sockets are of the closed-entry type.

The temperature range for this connector is -55°C (-67°F) to +125°C (+257°F) and meets the requirements of MIL-C-5015.

The F80 modification (crimp contact termination) is available in resilient insulators in the E, R, F, and BFR styles, creating a large selection of insert assemblies and hardware. Components are identical to the MS-5015 except that the contacts are modified for crimp termination providing an inexpensive crimp contact connector with the proven reliability of and complete intermateability with the MS-5015 series. See page 187 for assembly instructions. Cable clamps have been integrally designed with the endbell on MS-E and MS-F connectors. Class R is without the cable clamp.

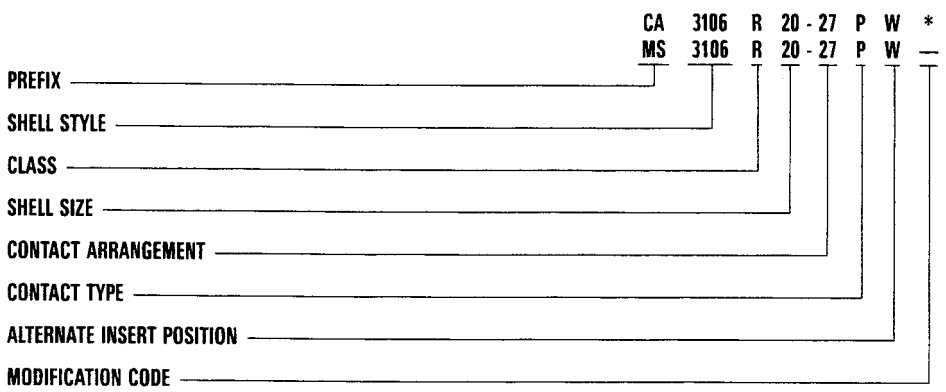

- PREFIX**  
MS - Conforms to latest MIL-C-5015 revision  
CA - Cannon designation (for any modification)
- SHELL STYLE**  
3100 - Wall mounting receptacle  
3101 - Cable connecting plug  
3102 - Box mounting receptacle  
\* 3106 - Straight plug  
3108 - 90° angle plug
- CLASS**  
E/F - Environmental with resilient insulators and integral cable clamp.  
R - Environmental with resilient insulators and shortened lightweight endbell; also additional sealing with O ring seal under coupling nut in styles 3106 and 3108

- SHELL SIZE**  
Coupling thread diameter in sixteenths of an inch
- CONTACT ARRANGEMENTS**  
See pages 171-174
- CONTACT TYPE**  
P for Pin; S for Socket
- ALTERNATE INSERT POSITION**  
W, X, Y and Z (omit for "Normal")
- MODIFICATION CODE**  
(applies to CA numbers only, not MS)  
F80 - Crimp type contacts. See page 187 for assembly instructions.

\* When ordering MS3106F to the Cannon part number, designate CA06R. See pages 177 and 181.

Performance and Material Specifications

**MATERIALS AND FINISHES**

Shell	Material	Aluminum alloy
	Finish	O.D. Chromate coating over cadmium plating
Insulator	Material	Polychloroprene (resilient)
Contacts	Material	Brass or copper alloy
	Finish	Silver plate
	Termination	Tinned solder pot

**WIRING**

For class E, R and F connectors, satisfactory moisture sealing will be obtained if AWG and MS wire sizes and insulation outside diameters are governed by this table.

Contact Size	Wire Size (MIL-W-5086)	Insulation OD Limit (inches)
16	16 thru 20	.064 (1.63) min. to .130 (3.30) max.
12	12 thru 14	.114 (2.90) min. to .170 (4.32) max.
8	8 thru 10	.164 (4.17) min. to .255 (6.48) max.
4	4 thru 6	.275 (6.98) min. to .370 (9.40) max.
0	0 thru 2	.415 (10.54) min. to .550 (13.97) max.

**ELECTRICAL SERVICE DATA**

Test current ratings of contacts and allowable voltage drop under test conditions when assembled as in service are shown below. Maximum total current to be carried per connector is the same as the allowable in wire bundles as specified in MIL-W-5088.

Contact Size	Test Current (amps)	Potential Drop (millivolts)
16	13	49
12	23	42
8	46	26
4	80	23
0	150	21

**CONTACTS**

Pin and socket contacts are designed to resist severe vibration and repeated connection and disconnection. The average force to either engage or separate pin and socket contacts will not exceed the average values given in the latest revision of MIL-C-5015.

Force in Lbs.	Contact Sizes				
	16	12	8	4	0
Maximum	3.00	5.00	10.00	15.00	20.00
Average	2.10	3.50	7.00	10.50	14.00
Minimum	.25	.50	.75	1.00	2.00

**THERMOCOUPLE CONTACTS**

Sizes 12 and 16 contacts, machined from matching thermocouple lead wire alloys, can be supplied in ITT Cannon connectors. These thermocouple contacts maintain continuity from thermal-sensor leads thru a bulkhead of other closures in temperature measuring applications.

These contacts for matching lead wires are detailed by the standards of the Instrument Society of America (I.S.A.):

I.S.A. Standards	Material
J and Y	Iron and constantan
K	Chromel and alumel
T	Copper and constantan

Since the thermocouple connector application determines the soldering methods and materials to be used, thermocouple contacts, identified by permanent markings, are normally supplied with untinned solder pots. Thermocouple contacts are supplied only in connectors having resilient insulators.

**HIGH POTENTIAL TEST VOLTAGE**

MS connectors show no evidence of breakdown when the test voltage given below is applied between the two closest contacts and between the shell and the contacts closest to the shell for a period of one minute.

MS Service Rating	Test Voltage (RMS) 60 cps	Suggested* Operating Voltages		Air Spacing Nom. (inches)	Creepage Distance Nom. (inches)
		DC	AC (rms)		
Inst.	1000	250	200		1/16
A	2000	700	500	1/16	1/8
D	2800	1250	900	1/8	3/16
E	3500	1750	1250	3/16	1/4
B	4500	2450	1750	1/4	5/16
C	7000	4200	3000	5/16	1

\*As indicated in previous MS Specification and to be used by designer only as a guide.

High Voltage Cartridges for MS-E and MS-R (HV310\*E/R Series)

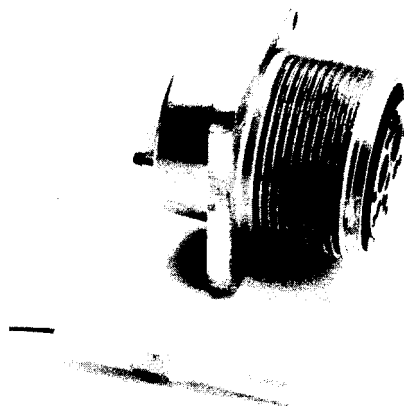

High voltage conductors as well as power and/or control signal conductors can now be connected simultaneously in standard MS connectors. Previously, MS connectors involved in high voltage circuitry required individual design considerations and could only be ordered as a "special." The new high voltage cartridge allows conversion of a standard connector to one capable of handling up to 15,000 volts DC (Test Voltage — mated), operating voltage — Sea level 5,000 VDC or 3,500 VAC. These cartridges are molded of nylon and provide a high degree of arc-over protection between adjacent contacts or between a contact and the connector shell. Unmated, each cartridge provides a nylon isolating barrier capable of withstanding up to 10,000 volts DC (or peak).

The contact within the cartridge is a 7.5 amp, size 20, crimp snap-in type with dielectric rear release clip retention. This contact is removable with the plastic CIET20 insertion/extraction tool provided the insulation is .084 (22.45) or less. The contact may be crimped with the standard MS-3191 tool and MS-3191-20A locator and hand inserted into the nylon cartridge. The cartridge body is installed in the connector at the factory.

High voltage cartridges now available fit the space normally occupied by a #4 or #8 size contact in an MS-E, MS-R or MS-F type connector.

Over forty-nine contact arrangements are currently available in which these high voltage cartridges may be used. Consult factory for ordering information.

- Standard contact arrangements are adaptable to high voltage applications.
- Eliminates need for a separate high voltage connector.
- Assembly time is reduced.

MS Alternate Insert Positions

All views are looking into front of pin insert or rear of socket insert.

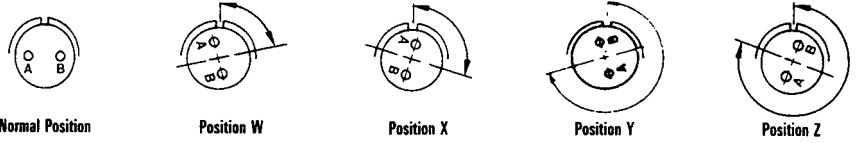

Shell Size	Contact Arrangement	Wire Size	Service Rating	Alternate Positions—Degrees				Shell Size	Contact Arrangement	Wire Size	Service Rating	Alternate Positions—Degrees				Shell Size	Contact Arrangement	Wire Size	Service Rating	Alternate Positions—Degrees										
				W	X	Y	Z					W	X	Y	Z					W	X	Y	Z							
8S	8S-1	1 #16	A	—	—	—	—	20	20-22	3 #16	A	80	110	250	280	28	28-10	3 #12	D(G)	80	110	250	280							
10S	10S-2	1 #16	A	—	—	—	—	20	20-23	3 #8	A	35	110	250	325	28	28-11	2 #8	A (all others)	80	110	250	280							
	10SL-4	2 #16	A	—	—	—	20-24		2 #8	A	4 #12						A													
	10SL-3	3 #16	A	—	—	—	2 #8		A	26 #16	A																			
12	12-5	1 #12	D	—	—	—	—	20-27	14 #16	A	35	110	250	325	28-12	4 #12	A	90	180	270	—									
12S	12S-4	1 #16	D	—	—	—	—	20	20-29	17 #16	A	80	—	—	280	28-15	35 #16	A	80	110	250	280								
	12S-3	2 #16	A	70	145	215	290		20-33	11 #16	A					28-16	20 #16	A												
14	14-3	1 #8	A	—	—	—	—	22	22-2	3 #8	D	70	145	215	290	* 28-17	15 #16	A(A-L), B(R)	80	110	250	280								
14S	14S-1	3 #16	A	—	—	—	—		* 22-4	2 #12	A	35	110	250	325	* 28-19	6 #16	A(C,E,G,J,K,L)					80	110	250	280				
	14S-2	4 #16	Inst.	—	120	240	—	22-5	4 #16	D	35	110	250	325	4 #12	A														
	14S-5	5 #16	Inst.	—	110	—	—	22-6	2 #12	D	80	110	250	280	4 #16	A														
	14S-6	6 #16	Inst.	—	—	—	—	22-7	1 #16	D	80	110	250	280	10 #12	D(M-P)														
	14S-7	3 #16	A	90	180	270	—	22-8	2 #8	D	80	110	250	280	37 #16	A														
14S-9	2 #16	A	70	145	215	290	22-9	1 #0	E	—	—	—	—	* 28-22	3 #16	D	70	145	215	290										
16	16-9	2 #16	A	35	110	250	325	22-10	3 #12	E	70	145	215	290	32	* 32-1	3 #12	E(A)	80	110	250	280								
	16-10	3 #12	A	90	180	270	—	22-11	4 #16	E	35	110	250	325		2 #0	D (all others)													
	16-12	1 #4	A	—	—	—	—	22-12	2 #16	B	35	110	250	325		* 32-6	16 #16	A					80	110	250	280				
	16-11	2 #12	A	35	110	250	325	22-13	3 #16	D	80	110	250	280		2 #12	A													
	16-13	2 #12	A	35	110	250	325	22-14	1 #16	A(A-D)	35	110	250	325		3 #8	A													
	16S	16S-1	7 #16	A	80	—	—	280	22-15	4 #12	D(E)	80	—	—		280	32-7	28 #16									Inst. (A,B,h,j)	80	125	235
* 16S-4		2 #16	D	35	110	250	325	* 22-15	19 #16	A	80	110	250	280	7 #12	A (all others)														
16S-5		3 #16	A	70	145	215	290	22-17	1 #16	A(A-C,E,F)	80	110	250	280	32-8	24 #16	A													
16S-6		3 #16	A	90	180	270	—	22-18	5 #12	E(D)	80	110	250	280	6 #12	A														
16S-8		5 #16	A	—	170	265	—	22-19	8 #16	D(A)	80	110	250	280	* 32-9	12 #16	D	80	110	250	280									
18	18-1	10 #16	A(B,C,E,G)	70	145	215	290	22-20	1 #12	A (all others)	80	110	250	280	2 #4	D														
	18-3	2 #12	Inst. (all others)	35	110	250	325	22-21	8 #16	A (C-E)	80	110	250	280	2 #0	D														
	18-4	4 #16	D	35	110	250	325	22-22	14 #16	D (all others)	80	110	250	280	6 #12	D														
	18-5	1 #16	D	80	110	250	280	22-23	9 #16	A	35	110	250	325	32-15	2 #0	D													
	18-7	1 #8	B	—	—	—	—	22-24	4 #16	A	—	110	250	—	32-17	4 #4	D					45	110	250	—					
	18-8	7 #16	A	70	—	—	290	22-25	8 #12	D(H)	35	—	250	—	36	* 36-4	3 #0	A(B,C)	70	145	215	290								
	18-9	1 #12	A	—	—	—	—	* 22-27	8 #16	A (all others)	80	—	250	280		36-5	4 #0	D(A)					—	120	240	—				
	18-10	4 #12	A	—	120	240	—	22-26	1 #8	A (all others)	80	—	—	280	36-6	4 #4	A	35	110	250	325									
	18-11	5 #12	A	—	170	265	—	22-28	7 #12	A	80	—	—	280	36-7	2 #0	A	80	110	250	280									
	18-12	6 #16	A	80	—	—	280	24	24-2	7 #12	D	80	—	—	280	36-8	40 #16	A	80	110	250	280								
* 18-13	3 #12	A	80	110	250	280	* 24-5		16 #16	A	80	110	250	280	36-9	7 #12	A													
* 18-15	4 #12	A	—	120	240	—	24-7	8 #12	D(A,G,H)	80	110	250	280	1 #12	A															
18-19	10 #16	A	—	120	240	—	* 24-9	14 #16	A (all others)	80	110	250	280	14 #12	A															
* 18-22	3 #16	D	70	145	215	290	* 24-11	2 #12	A	35	110	250	325	2 #8	A															
20	20-2	1 #0	D	—	—	—	—	24-12	3 #8	A	80	110	250	280	1 #4	A														
	20-3	3 #12	D	70	145	215	290	24-20	2 #4	A	35	110	250	325	48 #16	A														
	20-4	4 #12	D	45	110	250	—	24-22	7 #8	A	80	—	—	280	6 #16	D														
	20-7	8 #16	A(C-F)	80	110	250	280	24-10	6 #12	A	35	110	250	325	5 #12	A														
	20-8	4 #16	D(A,B,G,H)	80	110	250	280	* 24-11	3 #8	A	80	110	250	280	5 #8	A														
	20-14	3 #12	Inst.	80	110	250	280	24-12	2 #12	A	80	110	250	280	36-14	1 #16	D (m)	60	125	245	305									
20-15	7 #12	A	80	—	—	280	24-20	9 #16	D	80	110	250	280	2 #8	A (all others)															
20-16	7 #16	A	80	110	250	280	24-22	2 #12	D	45	110	250	—	36-15	35 #16	A														
20-17	2 #12	A	80	—	—	280	24-22	4 #8	D	80	—	—	280	40	40-10	16 #16	A					65	125	225	310					
20-18	6 #16	A	35	110	250	325	24-27	7 #16	E	80	—	—	280	9 #8	A															
20-19	3 #8	A	90	180	270	—	24-28	24 #16	Inst.	80	110	250	280	4 #4	A															
28	28-1	6 #12	D(A,E,J)	80	110	250	280	28	28-1	6 #12	D(A,E,J)	80	110	250	280	* 40-56	85 #16	A	72	144	216					288				
	* 28-2	3 #8	A (all others)	35	110	250	325		3 #8	A (all others)	35	110	250	325	44	44-1	36 #16	D									65	125	225	310
	28-7	2 #4	D	35	110	250	325		2 #12	D	35	110	250	325	48	48-5	90 #16	A												
	28-9	6 #16	D	80	110	250	280		6 #12	D	80	110	250	280	1 #8	A														

\*Not MSA/B insert arrangements and polarization.

Circular Connectors

ITT Cannon Designated Alternate Insert Positions

Not MS approved

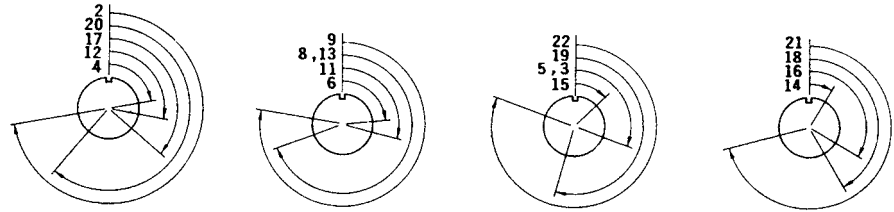

NOTE: Front view of pin insulator rotates as shown.

Shell Size	Contact Arrangement	Wire Size	Service Rating	Available Position									
10SL	10SLA4	5 #20	A	2	3	5	8	12	13				
12S	12SA10	4 #16	Inst.	3	5	8	13						
20	20A37	4 #8	D										
24	24A24	12 #12	A	2	4	9	12						
28	28A16	5 #16	A	2	3	5	8	9	13				
	28A51	4 #4 43 #16	A	3	4	5	8	9	12	13			
32	32A10	54 #16	A	2	3	4	5	8	9	12	13		
	32A47	47 #16	A	2	3	4	5	8	9	12	13		
36	36A16	18 #12	A	2	3	4	5	8	9	12	13	15	20
	36A34	52 #16	A	2	3	4	5	8	9	12	13		
	36A46	27 #12	A	2	3	4	5	8	9	12	13		
	36A66	52 #16 4 #12	A	2	3	5	8	9	13	17	18		
40	40A27	60 #16	A	4	14	17	20	22					
	40A33	7 #8	A	2	3	5	8	13					
		6 #4											

Note: For ITT Cannon contact arrangements not listed, consult factory.

Position	Angle (degrees)
Normal	0
2	260
3	110
4	80
5	use pos. 3
6	85
8	250
9	280
11	105
12	100
13	use pos. 8
14	30
15	45
16	120
17	130
18	150
19	195
20	220
21	255
22	290
23	165
24	330
25	235
26	125

Circular Connectors

Contact Arrangements (Face View Pin Insert)

LEGEND

- Resilient only
- ▲ Resilient & Plastic

⌀ High Volume Layouts — readily available from Cannon Distributors

Shell Size	8S-1	10S-2	10SL-4	10SL-3	10SLA4	12S-4	12-5	12S-3	12SA10	14-3	14S-9
No. of Contacts	1 #16	1 #16	2 #16	3 #16	5 #20	1 #16	1 #12	2 #16	4 #16	1 #8	2 #16
Service Rating	A	A	A	A	A	D	D	A	Inst.	A	A
Shell Size	14S-1	14S-7	14S-2	14S-5	14S-6	16-12	16-11	16S-4	16-13	16-13	
No. of Contacts	3 #16	3 #16	4 #16	5 #16	6 #16	1 #4	2 #12	2 #16	2 #12	(A-Iron B-Constantan)	
Service Rating	A	A	Inst.	Inst.	Inst.	A	A	D	A	A	
Shell Size	16S-5	16S-6	16-10	16-9	16S-8	16S-1	18-7	18-3			
No. of Contacts	3 #16	3 #16	3 #12	2 #16 (B,D) 2 #12 (A,C)	5 #16	7 #16	1 #8	2 #12			
Service Rating	A	A	A	A	A	A	B	D			
Shell Size	18-5	18-22	18-4	18-10	18-13	18-15	18-11	18-12			
No. of Contacts	1 #16 (A) 2 #12 (B,C)	3 #16	4 #16	4 #12	3 #12 (B,C,D) 1 #8 (A)	4 #12 (A, C-Iron; B, D-Constantan)	5 #12	6 #16			
Service Rating	D	D	D	A	A	A	A	A			
Shell Size	18-9	18-8	18-1	18-19	20-2	20-23	20-3	20-19			
No. of Contacts	5 #16(B,C,E-G) 2 #12(A,D)	7 #16(A-G) 1 #12(H)	10 #16	10 #16	1 #0	2 #8	3 #12	3 #8			
Service Rating	Inst.	A	A(B,C,F,G) Inst. (all others)		A	D	A	D			
Shell Size	20-4	20-24	20A37	20-14	20-8	20-17	20-22	20-15			
No. of Contacts	4 #12	2 #16 (A,C) 2 #8 (B,D)	ITT Cannon pos. #8 of 20-4	3 #12 (C,D,E) 2 #8 (A,B)	4 #16(B,C,E,F) 2 #8(A,D)	1 #16(F) 5 #12(A-E)	3 #16(B,D,F) 3 #8(A,C,E)	7 #12			
Service Rating	D	A	D	A	Inst.	A	A	A			

Circular Connectors

Contact Arrangements (Continued)

LEGEND

- Resilient only
- ▲ Resilient & Plastic
- ⚡ High Volume Layouts — readily available from Cannon Distributors

Circular Connectors

Shell Size	20-7	20-16	20-18	20-33	20-11	20-27	20-29	22-7
No. of Contacts	8 #16	7 #16(A-G) 2 #12(H,I)	6 #16(A,C-E,G,H) 3 #12(B,F,I)	11 #16	13 #16	14 #16	17 #16	1 #0
Service Rating	A(C-F) D(A,B,G,H)	A	A	A	Inst.	A	A	E
Shell Size	22-11	22-2	22-6	22-9	22-4	22-10	22-22	22-12
No. of Contacts	2 #16	3 #8	1 #16(B) 2 #8(A,C)	3 #12	2 #12 (A,C) 2 #8 (B,D)	4 #16	4 #8	3 #16 (A,C,D) 2 #8 (B,E)
Service Rating	B	D	D	E	A	E	A	D
Shell Size	22-13	22-5	22-15	22-28	22-18	22-23	22-17	22-20
No. of Contacts	1 #16 (E) 4 #12 (A-D)	4 #16(A,C,D,F) 2 #12(B,E)	1 #16(D) 5 #12 (A-C,E,F)	7 #12	8 #16	8 #12	8 #16(A-D,F-J) 1 #12(E)	9 #16
Service Rating	A (A-D), D (E)	D	A(A-C,E,F), E(D)	A	A(C-E) D(all others)	D(H) A (all others)	D(A), A(all others)	A
Shell Size	22-27	22-19	22-14	24-9	24-22	24-12	24-2	24-10
No. of Contacts	8 #16(A-H) 1 #8(J)	14 #16	19 #16	2 #4	4 #8	3 #12 (B,D,E) 2 #4 (A,C)	7 #12	7 #8
Service Rating	D(J), A (all others)	A	A	A	D	A	D	A
Shell Size	24-27	24-6	24-11	24-20	24-19	24A24	24-5	24-7
No. of Contacts	7 #16	8 #12	6 #12(A-C, G-I) 3 #8(D-F)	9 #16(A-D,G-L) 2 #12(E,F)	12 #16 6 #12(B-G)	12 #12	16 #16	14 #16 (A-M, O) 2 #12 (P, N)
Service Rating	E	D(A,G,H) A (all others)	A	D	A	A	A	A

Contact Arrangements (Continued)

LEGEND

- Resilient only
- ▲ Resilient & Plastic

♠ High Volume Layouts — readily available from Cannon Distributors

Shell Size	24-28	28-7	28-22	28-10	28-1	28A16	28-19
No. of Contacts	24 #16	2 #4	3 #16(D-F) 3 #4(A-C)	3 #12(A,F,G) 2 #8(B,E) 2 #4(C,D)	6 #12(A,B,D-F,H) 3 #8(C,J,G)	5 #16(A,D-F,J) 4 #4(B,C,G,H)	6 #16(A-C,H,L,M) 4 #12(E,G,J,K)
Service Rating	Inst.	D	D	D(G), A(all others)	D(A,E,J) A (all others)	A	A (C,E,G,J,K,L) B (H,M), D(A,B)

Shell Size	28-9	28-2	28-20	28-17	28-16	28-11	28-12
No. of Contacts	6 #16(A,H-M) 6 #12(B-G)	12 #16 (A, L, N) 2 #12 (M, P)	4 #16 (K-N) 10 #12 (A-J, P)	15 #16	20 #16	18 #16 (A-I, N-X) 4 #12 (J-M)	26 #16
Service Rating	D	D	A	A (A-L), B (R) D (M-P)	A	A	A

Shell Size	28-15	28-21	28A51	32-17	32-1	32-15	32-9
No. of Contacts	35 #16	37 #16	43 #16	4 #4	3 #12 (A,C,D) 2 #0 (B,E)	2 #0(A,G) 6 #12(B,C,D,E,F,H)	12 #16 (C-N) 2 #4 (A, B)
Service Rating	A For new MIL equip. design, use 28-21	A	A	D	E (A), D (all others)	D	D

Shell Size	32-6	32-8	32-7	32A47	32A10	36-4
No. of Contacts	16 #16(A-O,S) 2 #12(U,V) 3 #8(P,R,T) 2 #4(W,X)	24 #16(A-L,T-Z,a-e) 6 #12 (M-S) 2 #8(O,R)	28 #16 (A-N,W-Z,a-k) 7 #12(O-V)	47 #16	54 #16	3 #0
Service Rating	A	A For new MIL equip. design, use 32-7	Inst. (A,B,h,j) A (all others)	A	A	A (B,C), C (A)

\*NOTE: Additional layouts are the same as shown but in unique alternate positions. Please consult the factory.

Circular Connectors

Contact Arrangements (Continued)

Circular Connectors

LEGEND

- Resilient only
- ▲ Resilient & Plastic

∅ High Volume Layouts — readily available from Cannon Distributors

† Grommet not available. Consult factory for ordering connectors with this arrangement.

Shell Size	36-5	36-6	36-14	36A16	36A46	36-9
No. of Contacts	4 #0	4 #4(B,C,E,F) 2 #0(A,D)	6 #16 (K-N, P, Q) 5 #12 (B, D, F, H, J) 5 #8 (A, C, E, G, I)	18 #12 (B, C, V, J, K, M, N, R, T-Iron; A, D-F, H, L, P, S, U-Constantan)	27 #12	14 #16(A-G,Z-f) 14 #12 (H-N,S-Y) 2 #8 (O, R) 1 #4(P)
Service Rating	A	A	D	A	A	A

Shell Size	36-15	36-7	36-8	36-10	36A34	36A66
No. of Contacts	35 #16	40 #16(A-Z,a-s) 7 #12(t-z)	46 #16(A-X,Z-z) 1 #12(Y)	48 #16	52 #16	52 #16(A-c,h-AK) 4 #12(d,e,f,g)
Service Rating	D (m), A (all others)	A	A	A	A	A

Shell Size	40A33	40-10	40A27	40-56
No. of Contacts	7 #8 (G-N) 6 #4 (A-F)	16 #16(A,B,E-H,M,N,P, Q,V-Y,b,c) 9 #8(C,D,I,L,O,R,U,Z,a) 4 #4(K,J,S,T)	60 #16	85 #16
Service Rating	A	A	A	A

Shell Size	44-1	48-5
No. of Contacts	36 #16(A-S,Z-t) 6 #12(T-Y)	90 #16(A-BL,BN-BT,BW,BX) 1 #8(CD) 9 #12(BM,BU,BV,BY-CC,CE)
Service Rating	D	A



Cable Connecting Plug (Receptacle with no mounting flange)

MS310E/MS310F  
Integral Cable Clamp

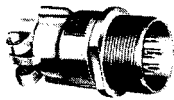

CA310E/CA310E

MS310E cable connecting plugs are used for cable extension requirements, where mounting provisions are unnecessary.

MS310E plugs mate with 3106, 3107 and 3108 plugs. Note: the D revision of MIL-C-5015 has changed the nomenclature of the 3101 from receptacle to plug.

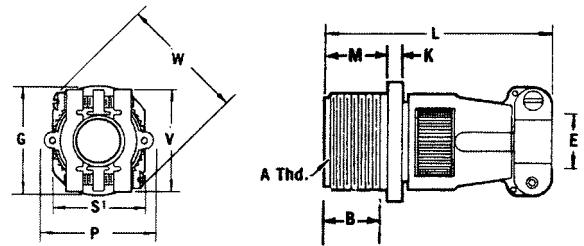

MS3101R



CA3101R

MS3101R cable connecting plug is identical in purpose to the MS3101E. The MS3101R features a shorter lightweight endbell and mates with 3106, 3107 and 3108 plugs. Note: The D revision of the MIL-C-5015 specification has changed the nomenclature of the 3101 from receptacle to plug.

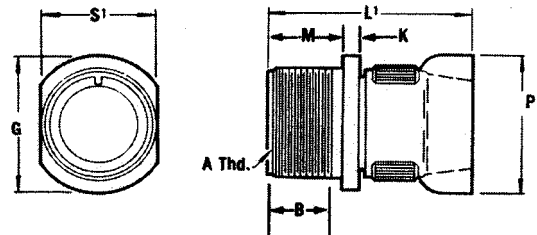

Shell Size	B Min.	E Max.	E Min.	G Max.	K Max.	L Max.	L' Max.	M +.031 (0.79) -.000 (0.00)	P Max.	S' Max.	V Max.	W Max.
8S	.375 (9.53)	.235 (5.97)	.102 (2.59)	.844 (21.44)	.125 (3.18)	2.250 (57.15)	1.838 (46.69)	.562 (14.27)	.890 (22.61)	.515 (13.08)	.840 (21.34)	1.046 (26.57)
10S	.375 (9.53)	.235 (5.97)	.102 (2.59)	.969 (24.61)	.125 (3.18)	2.250 (57.15)	1.838 (46.69)	.562 (14.27)	.890 (22.61)	.640 (16.26)	.840 (21.34)	1.046 (26.57)
10SL	.375 (9.53)	.297 (7.54)	.140 (3.56)	1.062 (26.97)	.125 (3.18)	2.250 (57.15)	1.838 (46.69)	.562 (14.27)	.970 (24.64)	.640 (16.26)	.900 (22.86)	1.125 (28.58)
12S	.375 (9.53)	.297 (7.54)	.140 (3.56)	1.062 (26.97)	.140 (3.56)	2.250 (57.15)	1.838 (46.69)	.562 (14.27)	.970 (24.64)	.765 (19.43)	.900 (22.86)	1.125 (28.58)
14S	.375 (9.53)	.422 (10.72)	.195 (4.95)	1.156 (29.36)	.140 (3.56)	2.250 (57.15)	1.838 (46.69)	.562 (14.27)	1.150 (29.21)	.890 (22.61)	1.100 (27.94)	1.343 (34.11)
16S	.375 (9.53)	.547 (13.89)	.255 (6.48)	1.281 (32.54)	.140 (3.56)	2.250 (57.15)	1.838 (46.69)	.562 (14.27)	1.250 (31.75)	1.015 (25.78)	1.200 (30.48)	1.484 (37.69)
12	.625 (15.88)	.297 (7.54)	.140 (3.56)	1.062 (26.97)	.146 (3.71)	2.625 (66.68)	2.181 (55.40)	.750 (19.05)	.970 (24.64)	.765 (19.43)	.900 (22.86)	1.125 (28.58)
14	.625 (15.88)	.422 (10.72)	.195 (4.95)	1.156 (29.36)	.146 (3.71)	2.625 (66.68)	2.181 (55.40)	.750 (19.05)	1.150 (29.21)	.890 (22.61)	1.100 (27.94)	1.343 (34.11)
16	.625 (15.88)	.547 (13.89)	.255 (6.48)	1.281 (32.54)	.146 (3.71)	2.625 (66.68)	2.181 (55.40)	.750 (19.05)	1.250 (31.75)	1.015 (25.78)	1.200 (30.48)	1.484 (37.69)
18	.625 (15.88)	.610 (15.49)	.285 (7.24)	1.344 (34.14)	.180 (4.57)	2.688 (68.28)	2.281 (55.40)	.750 (19.05)	1.450 (36.83)	1.140 (28.96)	1.300 (33.02)	1.609 (40.87)
20	.625 (15.88)	.735 (18.67)	.350 (8.89)	1.500 (38.10)	.180 (4.57)	2.750 (69.85)	2.281 (55.40)	.750 (19.05)	1.570 (39.88)	1.265 (32.13)	1.500 (38.10)	1.890 (48.01)
22	.625 (15.88)	.740 (18.80)	.350 (8.89)	1.625 (41.28)	.180 (4.57)	2.750 (69.85)	2.281 (55.40)	.750 (19.05)	1.570 (39.88)	1.390 (35.31)	1.500 (38.10)	1.890 (48.01)
24	.625 (15.88)	.922 (23.42)	.468 (11.89)	1.750 (44.45)	.203 (5.16)	2.969 (75.41)	2.281 (55.40)	.812 (20.62)	1.880 (47.75)	1.515 (38.48)	1.740 (44.20)	2.170 (55.12)
28	.625 (15.88)	.922 (23.42)	.468 (11.89)	2.000 (50.80)	.203 (5.16)	3.031 (76.99)	2.281 (55.40)	.812 (20.62)	1.880 (47.75)	1.765 (44.83)	1.740 (44.20)	2.170 (55.12)
32	.625 (15.88)	1.235 (31.37)	.664 (15.87)	2.250 (57.15)	.203 (5.16)	3.031 (76.99)	2.322 (58.98)	.875 (22.23)	2.205 (56.01)	2.015 (51.18)	2.075 (52.71)	2.656 (67.46)
36	.625 (15.88)	1.360 (34.54)	.694 (17.63)	2.500 (63.50)	.203 (5.16)	3.281 (83.34)	2.322 (58.98)	.875 (22.23)	2.400 (60.96)	2.270 (57.66)	2.300 (58.42)	2.922 (74.22)
*40	.625 (15.88)	1.628 (41.35)	.911 (23.14)	2.750 (69.85)	.203 (5.16)	3.530 (89.66)†	2.427 (61.65)†	.875 (22.23)	2.840 (72.14)	2.427 (61.65)	2.688 (68.28)	—

†Not to MS specification

\*Not Available in MS310E and MS3101R.

Shell Size	A Thread
8S	1/2-28UNEF-2A
10S	5/8-24UNEF-2A
10SL	5/8-24UNEF-2A
12S	3/4-20UNEF-2A
14S	7/8-20UNEF-2A
16S	1-20UNEF-2A
12	3/4-20UNEF-2A
14	7/8-20UNEF-2A

Shell Size	A Thread
16	1-20UNEF-2A
18	1-1/8-18UNEF-2A
20	1-1/4-18UNEF-2A
22	1-3/8-18UNEF-2A
24	1-1/2-18UNEF-2A
28	1-3/4-18UNS-2A
32	2-18UNS-2A
36	2-1/4-16UN-2A
40	2-1/2-16UN-2A

Performance Specifications – Page 168

Contacts, Sealing Plugs, Assembly Tools – Page 187

Contact Arrangements – Page 171-174

Wall Mounting Receptacle

MS3100E/MS3100F  
Integral Cable Clamp

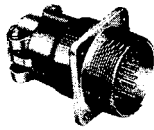

CA3100E/CA3100E

MS3100F wall mounting receptacles are used to carry wires thru walls or bulkheads, or to provide a means of disconnection at a bulkhead. MS3100F receptacles mate with 3106 and 3108 plugs.

MS3100E is identical to MS3100F and is available upon request. For new equipment, customer should specify MS3100F.

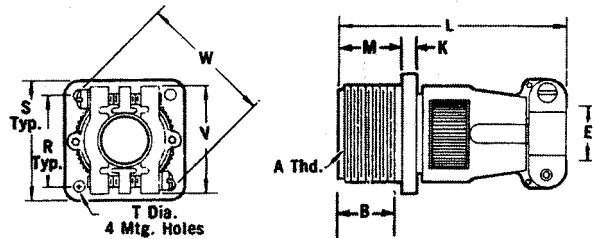

MS3100R

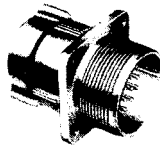

CA3100R

The MS3100R receptacle is identical in purpose to the MS3100F. The MS3100R features a shorter lightweight endbell and mates with 3106 and 3108 plugs.

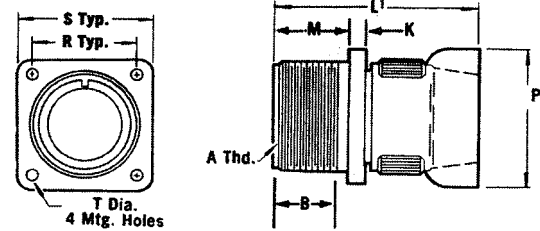

Shell Size	B Min.	E Max.	E Min.	K Max.	L Max.	L' Max.	M +.031 -.000	P Max.	R ±.005	S ±.031	T +.010 -.005	V Max.	W Max.
8S	.375 (9.53)	.235 (5.97)	.102 (2.59)	.125 (3.18)	2.250 (57.15)	1.838 (46.69)	.562 (14.27)	.890 (22.61)	.594 (15.09)	.875 (22.23)	.120 (3.05)	.840 (21.34)	1.046 (26.57)
10S	.375 (9.53)	.235 (5.97)	.102 (2.59)	.125 (3.18)	2.250 (57.15)	1.838 (46.69)	.562 (14.27)	.890 (22.61)	.719 (18.26)	1.000 (25.40)	.120 (3.05)	.840 (21.34)	1.046 (26.57)
10SL	.375 (9.53)	.297 (7.54)	.140 (3.56)	.125 (3.18)	2.250 (57.15)	1.838 (46.69)	.562 (14.27)	.970 (24.64)	.719 (18.26)	1.000 (25.40)	.120 (3.05)	.900 (22.86)	1.125 (28.58)
12S	.375 (9.53)	.297 (7.54)	.140 (3.56)	.140 (3.56)	2.250 (57.15)	1.838 (46.69)	.562 (14.27)	.970 (24.64)	.812 (20.62)	1.094 (27.79)	.120 (3.05)	.900 (22.86)	1.125 (28.58)
14S	.375 (9.53)	.422 (10.72)	.195 (4.95)	.140 (3.56)	2.250 (57.15)	1.838 (46.69)	.562 (14.27)	1.150 (29.21)	.906 (23.01)	1.188 (30.18)	.120 (3.05)	1.100 (27.94)	1.343 (34.11)
16S	.375 (9.53)	.547 (13.89)	.255 (6.48)	.140 (3.56)	2.250 (57.15)	1.838 (46.69)	.562 (14.27)	1.250 (31.75)	.969 (24.61)	1.281 (32.54)	.120 (3.05)	1.200 (30.48)	1.484 (37.69)
12	.625 (15.88)	.297 (7.54)	.140 (3.56)	.146 (3.71)	2.625 (66.68)	2.181 (55.40)	.750 (19.05)	.970 (24.64)	.812 (20.62)	1.094 (27.79)	.120 (3.05)	.900 (22.86)	1.125 (28.58)
14	.625 (15.88)	.422 (10.72)	.195 (4.95)	.146 (3.71)	2.625 (66.68)	2.181 (55.40)	.750 (19.05)	1.150 (29.21)	.906 (23.01)	1.188 (30.18)	.120 (3.05)	1.100 (27.94)	1.343 (34.11)
16	.625 (15.88)	.547 (13.89)	.255 (6.48)	.146 (3.71)	2.625 (66.68)	2.181 (55.40)	.750 (19.05)	1.250 (31.75)	.969 (24.61)	1.281 (32.54)	.120 (3.05)	1.200 (30.48)	1.484 (37.69)
18	.625 (15.88)	.610 (15.49)	.285 (7.24)	.180 (4.57)	2.688 (68.28)	2.281 (55.40)	.750 (19.05)	1.450 (36.83)	1.062 (26.97)	1.375 (34.93)	.120 (3.05)	1.300 (33.02)	1.609 (40.87)
20	.625 (15.88)	.735 (18.67)	.350 (8.89)	.180 (4.57)	2.750 (69.85)	2.281 (55.40)	.750 (19.05)	1.570 (39.88)	1.156 (29.36)	1.500 (38.10)	.120 (3.05)	1.500 (38.10)	1.890 (48.01)
22	.625 (15.88)	.740 (18.80)	.350 (8.89)	.180 (4.57)	2.750 (69.85)	2.281 (55.40)	.750 (19.05)	1.570 (39.88)	1.250 (31.75)	1.625 (41.28)	.120 (3.05)	1.500 (38.10)	1.890 (48.01)
24	.625 (15.88)	.922 (23.42)	.468 (11.89)	.203 (5.16)	2.969 (75.41)	2.281 (55.40)	.812 (20.62)	1.880 (47.75)	1.375 (34.93)	1.750 (44.45)	.147 (3.73)	1.740 (44.20)	2.170 (55.12)
28	.625 (15.88)	.922 (23.42)	.468 (11.89)	.203 (5.16)	3.031 (76.99)	2.281 (55.40)	.812 (20.62)	1.880 (47.75)	1.562 (39.67)	2.000 (50.80)	.147 (3.73)	1.740 (44.20)	2.170 (55.12)
32	.625 (15.88)	1.235 (31.37)	.664 (15.87)	.203 (5.16)	3.031 (76.99)	2.322 (58.98)	.875 (22.23)	2.205 (56.01)	1.750 (44.45)	2.250 (57.15)	.173 (4.39)	2.075 (52.71)	2.656 (67.46)
36	.625 (15.88)	1.360 (34.54)	.694 (17.63)	.203 (5.16)	3.281 (83.34)	2.322 (58.98)	.875 (22.23)	2.400 (60.96)	1.938 (49.23)	2.500 (63.50)	.173 (4.39)	2.300 (58.42)	2.922 (74.22)
*40	.625 (15.88)	1.628 (41.35)	.911 (23.14)	.203 (5.16)	3.530 (89.66)†	2.427 (61.65)†	.875 (22.23)	2.840 (72.14)	2.188 (55.58)	2.750 (69.85)	.173 (4.39)	2.688 (68.28)	—

†Not to MS specification

\*Not Available in MS3101E and MS3101R.

Shell Size	A Thread
8S	1/2-28UNEF-2A
10S	5/8-24UNEF-2A
10SL	5/8-24UNEF-2A
12S	3/4-20UNEF-2A
14S	7/8-20UNEF-2A
16S	1-20UNEF-2A
12	3/4-20UNEF-2A
14	7/8-20UNEF-2A

Shell Size	A Thread
16	1-20UNEF-2A
18	1-1/8-18UNEF-2A
20	1-1/4-18UNEF-2A
22	1-3/8-18UNEF-2A
24	1-1/2-18UNEF-2A
28	1-3/4-18UNS-2A
32	2-18UNS-2A
36	2-1/4-16UN-2A
40	2-1/2-16UN-2A

Performance Specifications – Page 168

Contacts, Sealing Plugs, Assembly Tools – Page 187

Contact Arrangements – Page 171-174



For technical assistance, price or delivery information, call your local technical sales office or distributor.

Dimensions are shown in inches (millimeters).  
Dimensions subject to change.

**Straight Plug**

**MS3106E/MS3106F**  
Integral Cable Clamp

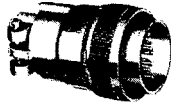

**CA3106E/CA06R**

MS3106F straight plugs mate with 3100 and 3102 receptacles and 3101 plugs. The MS3106E is available upon request. For new equipment, customer should specify MS3106F. MS3106E is identical to MS3106F except for O ring under the coupling nut.

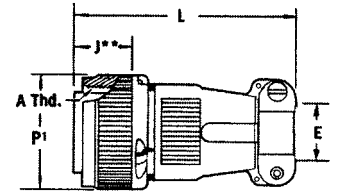
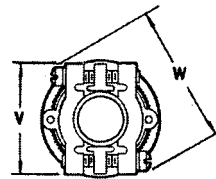

**MS3106R**



**CA3106R**

The MS3106R straight plug is identical in purpose to the MS3106F. The MS3106R has the shorter endbell. This plug will mate with 3100 and 3102 receptacles and 3101 plugs.

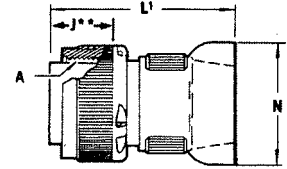
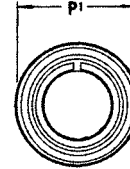

Shell Size	E Max.	E Min.	J** Max.	L Max.	L' Max.	N Max.	P' Max.	V Max.	W Max.
8S	.235 (5.97)	.102 (2.59)	.536 (13.61)	2.250 (57.15)	1.838 (46.69)	.890 (22.61)	.844 (21.44)	.840 (21.34)	1.046 (26.57)
10S	.235 (5.97)	.102 (2.59)	.536 (13.61)	2.250 (57.15)	1.838 (46.69)	.890 (22.61)	.969 (24.61)	.840 (21.34)	1.046 (26.57)
10SL	.297 (7.54)	.140 (3.56)	.536 (13.61)	2.250 (57.15)	1.838 (46.69)	.970 (24.64)	.969 (24.61)	.900 (22.86)	1.125 (28.58)
12S	.297 (7.54)	.140 (3.56)	.536 (13.61)	2.250 (57.15)	1.838 (46.69)	.970 (24.64)	1.062 (26.97)	.900 (22.86)	1.125 (28.58)
14S	.422 (10.72)	.195 (4.95)	.536 (13.61)	2.250 (57.15)	1.838 (46.69)	1.150 (29.21)	1.156 (29.36)	1.100 (27.94)	1.343 (34.11)
16S	.547 (13.89)	.255 (6.48)	.536 (13.61)	2.250 (57.15)	1.838 (46.69)	1.250 (31.75)	1.250 (31.75)	1.200 (30.48)	1.484 (37.69)
12	.297 (7.54)	.140 (3.56)	.724 (18.39)	2.625 (66.68)	2.181 (55.40)	.970 (24.64)	1.062 (26.97)	.900 (22.86)	1.125 (28.58)
14	.422 (10.72)	.195 (4.95)	.724 (18.39)	2.625 (66.68)	2.181 (55.40)	1.150 (29.21)	1.156 (29.36)	1.100 (27.94)	1.343 (34.11)
16	.547 (13.89)	.255 (6.48)	.724 (18.39)	2.625 (66.68)	2.181 (55.40)	1.250 (31.75)	1.250 (31.75)	1.200 (30.48)	1.484 (37.69)
18	.610 (15.49)	.285 (7.24)	.724 (18.39)	2.688 (68.28)	2.281 (58.40)	1.450 (36.83)	1.344 (34.14)	1.300 (33.02)	1.609 (40.87)
20	.735 (18.67)	.350 (8.89)	.724 (18.39)	2.750 (69.85)	2.281 (58.40)	1.570 (39.88)	1.469 (37.31)	1.500 (38.10)	1.890 (48.01)
22	.740 (18.80)	.350 (8.89)	.724 (18.39)	2.750 (69.85)	2.281 (58.40)	1.570 (39.88)	1.594 (40.49)	1.500 (38.10)	1.890 (48.01)
24	.922 (23.42)	.468 (11.89)	.724 (18.39)	2.969 (75.41)	2.281 (58.40)	1.880 (47.75)	1.719 (43.66)	1.740 (44.20)	2.170 (55.12)
28	.922 (23.42)	.468 (11.89)	.724 (18.39)	3.031 (76.99)	2.281 (58.40)	1.880 (47.75)	1.969 (50.01)	1.740 (44.20)	2.170 (55.12)
32	1.235 (31.37)	.664 (15.87)	.724 (18.39)	3.031 (76.99)	2.322 (58.98)	2.205 (56.01)	2.219 (56.36)	2.075 (52.71)	2.656 (67.46)
36	1.360 (34.54)	.694 (17.63)	.724 (18.39)	3.281 (83.34)	2.322 (58.98)	2.400 (60.96)	2.469 (62.71)	2.300 (58.42)	2.922 (74.22)
* 40	1.628 (41.35)	.911 (23.14)	.724 (18.39)	3.530 (89.66)†	2.427 (61.65)†	2.840 (72.14)	2.723 (69.16)†	2.688 (68.28)	—

†Not to MS specification

\*\*Barrel engaging face to shoulder.

Shell Size	A Thread
8S	1/2-28UNEF-2B
10S	5/8-24UNEF-2B
10SL	5/8-24UNEF-2B
12S	3/4-20UNEF-2B
14S	7/8-20UNEF-2B
16S	1-20UNEF-2B
12	3/4-20UNEF-2B
14	7/8-20UNEF-2B

Shell Size	A Thread
16	1-20UNEF-2B
18	1-1/8-18UNEF-2B
20	1-1/4-18UNEF-2B
22	1-3/8-18UNEF-2B
24	1-1/2-18UNEF-2B
28	1-3/4-18UNS-2B
32	2-18UNS-2B
36	2-1/4-16UN-2B
40	2-1/2-16UN-2B

Performance Specifications – Page 168

Contacts, Sealing Plugs, Assembly Tools – Page 187

Contact Arrangements – Page 171-174

Box Mounting Receptacle

MS3102E/MS3102R

CA3102E/CA3102R

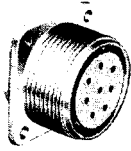

Shell Size	X DIMENSION				
	Max. Solder Pot Ext. — Pin or Socket				
	Contact Size				
8S, 10S, 10SL	.534	—	—	—	—
12S, 14S, 16S	.518	—	—	—	—
12	.705	.705	—	—	—
14	.705	.705	.767	—	—
16	.705	.705	.767	.767	—
18	.674	.674	.736	.736	—
20,22	.674	.674	.736	.736	.971
24,28	.612	.612	.674	.674	.909
32,36	.549	.549	.611	.611	.846

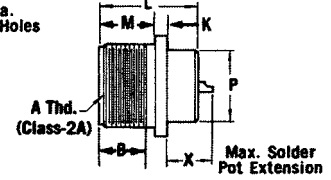
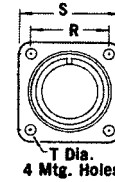

MS3102E and MS3102R box mounting receptacles are used in junction boxes or as an integral part of equipment. These connectors are identical in construction and will mate with 3106, 3107 and 3108 plugs. For new equipment, customer should specify MS3102R.

90° Angle Plug

MS3108E/MS3108R

CA3108E/CA3108R

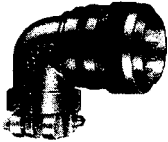

MS3108R 90° angle plugs (with O ring seal less cable clamp) and the MS3108E 90° angle plugs (less O ring seal with cable clamp) are used where there is limited space and where wires must be brought at abrupt angles. This plug will mate with 3100 and 3102 receptacles and 3101 plugs.

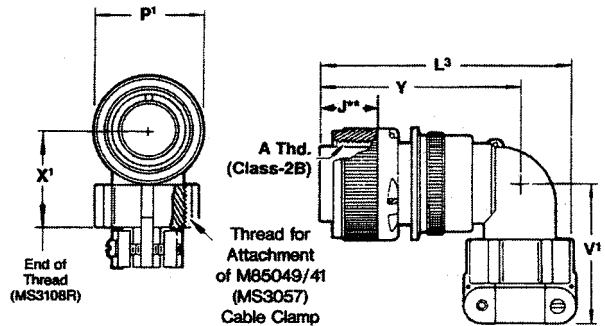

See page 185 for cable clamp dimensions.

Shell Size	B Min.	J** Max.	K Max.	L Max.	L <sup>3</sup> Max.	M +.031 (0.79) - .000 (0.00)	P Max.	P <sup>1</sup> Max.	R ±.005	S ±.031	T +.010 - .005	V <sup>1</sup> Max.	X <sup>1</sup> Max.	Y Max.
8S	.375 (9.53)	.536 (13.61)	.125 (3.18)	1.040 (26.42)	2.156 (54.76)	.562 (14.27)	.426 (10.82)	.844 (21.44)	.594 (15.09)	.875 (22.23)	.120 (3.05)	1.218 (30.94)	.811 (20.60)	1.640 (41.66)
10S	.375 (9.53)	.536 (13.61)	.125 (3.18)	1.040 (26.42)	2.156 (54.76)	.562 (14.27)	.520 (13.21)	.969 (24.61)	.719 (18.26)	1.000 (25.40)	.120 (3.05)	1.250 (31.75)	.842 (21.39)	1.640 (41.66)
10SL	.375 (9.53)	.536 (13.61)	.125 (3.18)	1.040 (26.42)	2.188 (55.58)	.562 (14.27)	.614 (15.60)	.969 (24.61)	.719 (18.26)	1.000 (25.40)	.120 (3.05)	1.281 (32.54)	.873 (22.17)	1.703 (43.26)
12S	.375 (9.53)	.536 (13.61)	.140 (3.56)	1.040 (26.42)	2.188 (55.58)	.562 (14.27)	.614 (15.60)	1.062 (26.97)	.812 (20.62)	1.094 (27.79)	.120 (3.05)	1.281 (32.54)	.873 (22.17)	1.703 (43.26)
14S	.375 (9.53)	.536 (13.61)	.140 (3.56)	1.040 (26.42)	2.312 (58.72)	.562 (14.27)	.739 (18.77)	1.156 (29.36)	.906 (23.01)	1.188 (30.18)	.120 (3.05)	1.406 (35.71)	.936 (23.77)	1.765 (44.83)
16S	.375 (9.53)	.536 (13.61)	.140 (3.56)	1.040 (26.42)	2.406 (61.11)	.562 (14.27)	.864 (21.95)	1.250 (31.75)	.969 (24.61)	1.281 (32.54)	.120 (3.05)	1.531 (38.89)	.998 (25.35)	1.796 (45.62)
12	.625 (15.88)	.724 (18.39)	.146 (3.71)	1.400 (35.56)	2.531 (64.29)	.750 (19.05)	.614 (15.60)	1.062 (26.97)	.812 (20.62)	1.094 (27.79)	.120 (3.05)	1.281 (32.54)	.873 (22.17)	2.062 (52.37)
14	.625 (15.88)	.724 (18.39)	.146 (3.71)	1.400 (35.56)	2.688 (68.28)	.750 (19.05)	.739 (18.77)	1.156 (29.36)	.906 (23.01)	1.188 (30.18)	.120 (3.05)	1.406 (35.71)	.936 (23.77)	2.125 (53.98)
16	.625 (15.88)	.724 (18.39)	.146 (3.71)	1.400 (35.56)	2.781 (70.64)	.750 (19.05)	.864 (21.95)	1.250 (31.75)	.969 (24.61)	1.281 (32.54)	.120 (3.05)	1.531 (38.89)	.998 (25.35)	2.156 (54.76)
18	.625 (15.88)	.724 (18.39)	.180 (4.57)	1.400 (35.56)	2.844 (72.24)	.750 (19.05)	.989 (25.12)	1.344 (34.14)	1.062 (26.97)	1.375 (34.93)	.120 (3.05)	1.593 (40.46)	1.061 (26.95)	2.250 (57.15)
20	.625 (15.88)	.724 (18.39)	.180 (4.57)	1.400 (35.56)	3.250 (82.55)	.750 (19.05)	1.145 (29.08)	1.469 (37.31)	1.156 (29.36)	1.500 (38.10)	.120 (3.05)	1.656 (42.06)	1.123 (28.52)	2.312 (58.72)
22	.625 (15.88)	.724 (18.39)	.180 (4.57)	1.400 (35.56)	3.250 (82.55)	.750 (19.05)	1.270 (32.26)	1.594 (40.49)	1.250 (31.75)	1.625 (41.28)	.120 (3.05)	1.718 (43.64)	1.186 (30.12)	2.312 (58.72)
24	.625 (15.88)	.724 (18.39)	.203 (5.16)	1.400 (35.56)	3.719 (94.46)	.812 (20.62)	1.395 (35.43)	1.719 (43.66)	1.375 (34.93)	1.750 (44.45)	.147 (3.73)	1.890 (48.01)	1.263 (32.08)	2.531 (64.29)
28	.625 (15.88)	.724 (18.39)	.203 (5.16)	1.400 (35.56)	3.719 (94.46)	.812 (20.62)	1.614 (41.00)	1.969 (50.01)	1.562 (39.67)	2.000 (50.80)	.147 (3.73)	1.968 (49.99)	1.342 (34.09)	2.531 (64.29)
32	.625 (15.88)	.724 (18.39)	.203 (5.16)	1.400 (35.56)	4.188 (106.38)	.875 (22.23)	1.864 (47.35)	2.219 (56.36)	1.750 (44.45)	2.250 (57.15)	.173 (4.39)	2.187 (55.55)	1.561 (39.65)	2.750 (69.85)
36	.625 (15.88)	.724 (18.39)	.203 (5.16)	1.400 (35.56)	4.297 (109.14)	.875 (22.23)	2.051 (52.10)	2.469 (62.71)	1.938 (49.23)	2.500 (63.50)	.173 (4.39)	2.406 (61.11)	1.780 (45.21)	2.875 (73.02)
40	.625 (15.88)	.724 (18.39)	.203 (5.16)	1.400 (35.56)	7.211 (183.16)†	.875 (22.23)	2.390 (60.71)	2.723 (69.16)†	2.188 (55.58)	2.750 (69.85)	.173 (4.39)	5.875 (149.22)	—	5.690 (144.53)

†Not to MS specification

\*\*Barrel engaging face to shoulder.

Shell Size	A Thread	
	Box Mounting Receptacle	90° Angle Plug
8S	1/2-28UNEF-2A	1/2-28UNEF-2B
10S	5/8-24UNEF-2A	5/8-24UNEF-2B
10SL	5/8-24UNEF-2A	5/8-24UNEF-2B
12S	3/4-20UNEF-2A	3/4-20UNEF-2B
14S	7/8-20UNEF-2A	7/8-20UNEF-2B
16S	1-20UNEF-2A	1-20UNEF-2B
12	3/4-20UNEF-2A	3/4-20UNEF-2B
14	7/8-20UNEF-2A	7/8-20UNEF-2B

Shell Size	A Thread	
	Box Mounting Receptacle	90° Angle Plug
16	1-20UNEF-2A	1-20UNEF-2B
18	1-1/8-18UNEF-2A	1-1/8-18UNEF-2B
20	1-1/4-18UNEF-2A	1-1/4-18UNEF-2B
22	1-3/8-18UNEF-2A	1-3/8-18UNEF-2B
24	1-1/2-18UNEF-2A	1-1/2-18UNEF-2B
28	1-3/4-18UNS-2A	1-3/4-18UNS-2B
32	2-18UNS-2A	2-18UNS-2B
36	2-1/4-16UN-2A	2-1/4-16UN-2B
40	2-1/2-16UN-2A	2-1/2-16UN-2B

Performance Specifications – Page 168

Contacts, Sealing Plugs, Assembly Tools – Page 187

Contact Arrangements – Page 171-174



For technical assistance, price or delivery information, call your local technical sales office or distributor.

Dimensions are shown in inches (millimeters). Dimensions subject to change.