

Thin-Film Directional Couplers



CP0805 Type

GENERAL DESCRIPTION

ITF (Integrated Thin-Film) TECHNOLOGY

The ITF SMD Coupler is based on thin-film multilayer technology. The technology provides a miniature part with excellent high frequency performance and rugged construction for reliable automatic assembly.

The ITF Coupler is offered in a variety frequency bands compatible with various types of high frequency wireless systems.

TOP VIEW

DIMENSIONS: millimeters (inches)

| 0805 | |
|----------|-------------------------|
| L | 2.03±0.1 (0.080±0.004) |
| W | 1.55±0.1 (0.061±0.004) |
| T | 0.98±0.1 (0.039±0.004) |
| A | 0.56±0.25 (0.022±0.010) |
| B | 0.35±0.15 (0.014±0.006) |

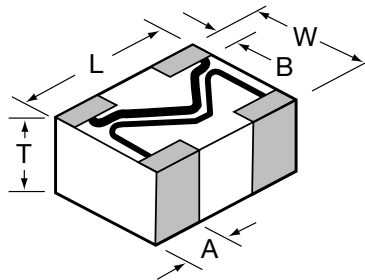

FEATURES

- Small Size: 0805
- Frequency Range: 800MHz - 3GHz
- Characteristic Impedance: 50Ω
- Operating / Storage Temp.: -40°C ÷ +85°C
- Power Rating: 3W Continuous
- Low Profile
- Rugged Construction
- Taped and Reeled

APPLICATIONS

- Mobile Communications
- Satellite TV Receivers
- GPS
- Vehicle Location Systems
- Wireless LAN's

HOW TO ORDER

| | | | | | | |
|---|---|---|---|--|---|---|
| CP ┆ Style Directional Coupler | 0805 ┆ Size 0805 | A ┆ Layout Type (see layout types) | 0902 ┆ Frequency MHz | A ┆ Sub Type (see layout sub-types) | W ┆ Termination Code W = Nickel/Solder (Sn/Pb) | TR ┆ Packaging Code TR = Tape and Reel |
|---|---|---|---|--|---|---|

QUALITY INSPECTION

Finished parts are 100% tested for electrical parameters and visual characteristics. Each production lot is evaluated on a sample basis for:

- Static Humidity: 85°C, 85% RH, 160 hours
- Endurance: 125°C, I_R, 4 hours

TERMINATION

Nickel/Solder coating (Sn, Pb) compatible with automatic soldering technologies: reflow, wave soldering, vapor phase and manual.

Recommended Pad Dimensions (mm)

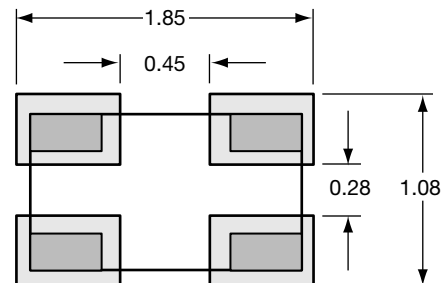

NOTE: Components must be mounted on the board with the white (Alumina) side DOWN.

Thin-Film Directional Couplers



Layout Types

LAYOUT

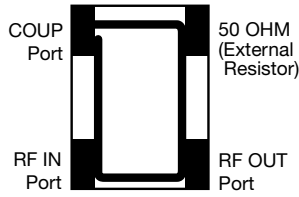

Type: A
Sub-Type: A

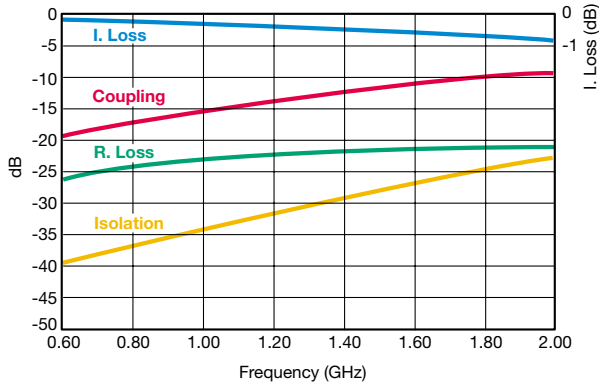

| APPLICATION | P/N | FREQUENCY BAND [MHz] | COUPLING [dB] | I. LOSS max | VSWR max | | |
|-------------|---------------|----------------------|---------------|-------------|----------|-----|-----|
| AMPS | CP0805A0836AW | 824 ÷ 849 | 16.5±1 | 0.25 | 1.2 | | |
| | CP0805A0881AW | 869 ÷ 894 | 16±1 | | | | |
| GSM | CP0805A0902AW | 890 ÷ 915 | 16±1 | | | | |
| | CP0805A0947AW | 935 ÷ 960 | 15.5±1 | | | | |
| E-GSM | CP0805A0897AW | 880 ÷ 915 | 16±1 | | | | |
| | CP0805A0942AW | 925 ÷ 960 | 15.5±1 | | | | |
| PDC | CP0805A1441AW | 1429 ÷ 1453 | 12±1 | | | 0.5 | 1.3 |
| PCN | CP0805A1747AW | 1710 ÷ 1785 | 10.5±1 | | | 0.7 | 1.4 |
| | CP0805A1842AW | 1805 ÷ 1880 | 10±1 | | | 0.8 | |
| PCS | CP0805A1880AW | 1850 ÷ 1910 | 9.5±1 | | | 0.6 | |
| | CP0805A1960AW | 1930 ÷ 1990 | 9.5±1 | | | | |
| PHP | CP0805A1907AW | 1895 ÷ 1920 | 9.5±1 | | | | |
| DECT | CP0805A1890AW | 1880 ÷ 1900 | 9.5±1 | | | | |

LAYOUT

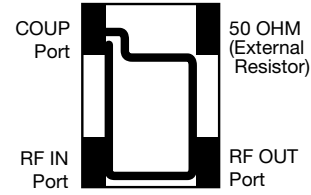

Type: A
Sub-Type: B

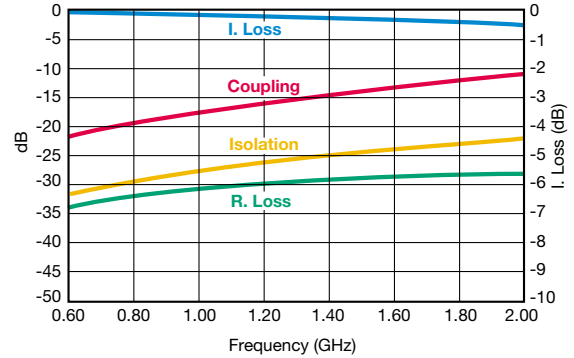

| APPLICATION | P/N | FREQUENCY BAND [MHz] | COUPLING [dB] | I. LOSS max | VSWR max | | |
|--------------|---------------|----------------------|---------------|-------------|----------|------|-----|
| AMPS | CP0805A0836BW | 824 ÷ 849 | 19±1 | 0.25 | 1.2 | | |
| | CP0805A0881BW | 869 ÷ 894 | 18.5±1 | | | | |
| GSM | CP0805A0902BW | 890 ÷ 915 | 18±1 | | | | |
| | CP0805A0947BW | 935 ÷ 960 | 18±1 | | | | |
| E-GSM | CP0805A0897BW | 880 ÷ 915 | 18.5±1 | | | | |
| | CP0805A0942BW | 925 ÷ 960 | 18±1 | | | | |
| PDC | CP0805A1441BW | 1429 ÷ 1453 | 14.5±1 | | | 0.35 | 1.4 |
| PCN | CP0805A1747BW | 1710 ÷ 1785 | 12.5±1 | | | 0.5 | |
| | CP0805A1842BW | 1805 ÷ 1880 | 12.5±1 | | | 0.6 | |
| PCS | CP0805A1880BW | 1850 ÷ 1910 | 12±1 | | | | |
| | CP0805A1960BW | 1930 ÷ 1990 | 11.5±1 | | | | |
| PHP | CP0805A1907BW | 1895 ÷ 1920 | 12±1 | | | | |
| DECT | CP0805A1890BW | 1880 ÷ 1900 | 12±1 | | | | |
| Wireless LAN | CP0805A2442BW | 2400 ÷ 2484 | 10±1 | 0.9 | | | |

Type: A
Sub-Type: C

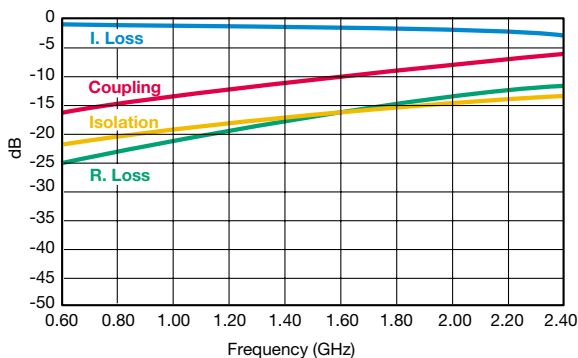

LAYOUT

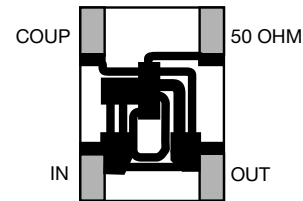

| APPLICATION | P/N | FREQUENCY BAND [MHz] | COUPLING [dB] | I. LOSS max | VSWR max | | |
|--------------|---------------|----------------------|---------------|-------------|----------|------|-----|
| AMPS | CP0805A0836CW | 824 ÷ 849 | 14±1 | 0.5 | 1.4 | | |
| | CP0805A0881CW | 869 ÷ 894 | 13.5±1 | | | | |
| GSM | CP0805A0902CW | 890 ÷ 915 | 13.5±1 | | | | |
| | CP0805A0947CW | 935 ÷ 960 | 13±1 | | | | |
| E-GSM | CP0805A0897CW | 880 ÷ 915 | 13.5±1 | | | | |
| | CP0805A0942CW | 925 ÷ 960 | 13±1 | | | | |
| PDC | CP0805A1441CW | 1429 ÷ 1453 | 9.5±1 | | | 1.15 | 1.8 |
| PCN | CP0805A1747CW | 1710 ÷ 1785 | 8±1 | | | 1.6 | 2.2 |
| | CP0805A1842CW | 1805 ÷ 1880 | 8±1 | | | | |
| PCS | CP0805A1880CW | 1850 ÷ 1910 | 7.5±1 | | | 1.75 | |
| | CP0805A1960CW | 1930 ÷ 1990 | 7.5±1 | | | | |
| PHP | CP0805A1907CW | 1895 ÷ 1920 | 7.5±1 | | | | |
| DECT | CP0805A1890CW | 1880 ÷ 1900 | 7.5±1 | | | | |
| Wireless LAN | CP0805A2442CW | 2400 ÷ 2484 | 6±1 | 2.5 | | | |

Thin-Film Directional Couplers



Layout Types

LAYOUT

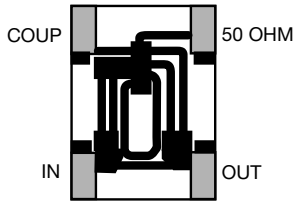

Type: A
Sub-Type: D

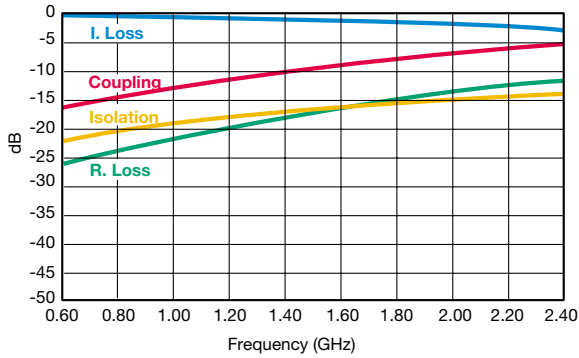

| APPLICATION | P/N | FREQUENCY BAND [MHz] | COUPLING [dB] | I. LOSS max | VSWR max |
|--------------|---------------|----------------------|---------------|-------------|----------|
| AMPS | CP0805A0836DW | 824 ÷ 849 | 13.0±1 | 0.5 | 1.4 |
| | CP0805A0881DW | 869 ÷ 894 | 12.5±1 | | |
| GSM | CP0805A0902DW | 890 ÷ 915 | 12.5±1 | 0.5 | 1.4 |
| | CP0805A0947DW | 935 ÷ 960 | 12±1 | | |
| E-GSM | CP0805A0897DW | 880 ÷ 915 | 12.5±1 | 0.5 | 1.4 |
| | CP0805A0942DW | 925 ÷ 960 | 12±1 | | |
| PDC | CP0805A1441DW | 1429 ÷ 1453 | 8.5±1 | 1.25 | 1.8 |
| PCN | CP0805A1747DW | 1710 ÷ 1785 | 7±1 | 1.85 | 1.8 |
| | CP0805A1842DW | 1805 ÷ 1880 | 7±1 | | |
| PCS | CP0805A1880DW | 1850 ÷ 1910 | 7±1 | 2.15 | 2.1 |
| | Cp0805A1960DW | 1930 ÷ 1990 | 6.5±1 | | |
| PHP | CP0805A1907DW | 1895 ÷ 1920 | 6.5±1 | 1.85 | 1.8 |
| DECT | CP0805A1890DW | 1880 ÷ 1900 | 7±1 | 1.85 | 1.8 |
| Wireless LAN | CP0805A2442DW | 2400 ÷ 2484 | 5.5±1 | 2.4 | 2.1 |

LAYOUT

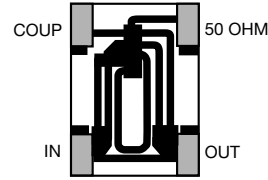

Type: A
Sub-Type: E

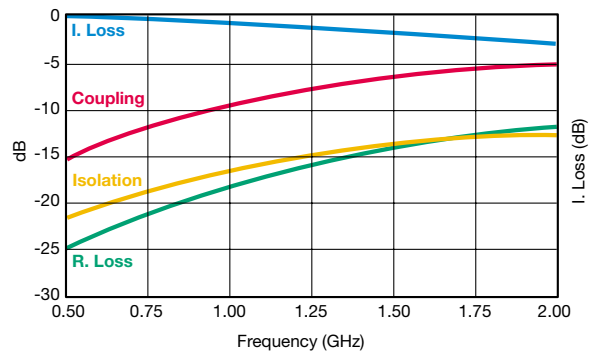

| APPLICATION | P/N | FREQUENCY BAND [MHz] | COUPLING [dB] | I. LOSS max | VSWR max |
|--------------|---------------|----------------------|---------------|-------------|----------|
| AMPS | CP0805A0836EW | 824 ÷ 849 | 11±1 | 0.85 | 1.4 |
| | CP0805A0881EW | 869 ÷ 894 | 10.5±1 | | |
| GSM | CP0805A0902EW | 890 ÷ 915 | 10.5±1 | 0.85 | 1.4 |
| | CP0805A0947EW | 935 ÷ 960 | 10±1 | | |
| E-GSM | CP0805A0897EW | 880 ÷ 915 | 10.5±1 | 0.85 | 1.4 |
| | CP0805A0942EW | 925 ÷ 960 | 10±1 | | |
| PDC | CP0805A1441EW | 1429 ÷ 1453 | 7±1 | 1.8 | 1.8 |
| PCN | CP0805A1747EW | 1710 ÷ 1785 | 5.5±1 | 2.7 | 2.2 |
| | CP0805A1842EW | 1805 ÷ 1880 | 5.5±1 | | |
| PCS | CP0805A1880EW | 1850 ÷ 1910 | 5±1 | 3.15 | 2.4 |
| | Cp0805A1960EW | 1930 ÷ 1990 | 5±1 | | |
| PHP | CP0805A1907EW | 1895 ÷ 1920 | 5±1 | 3.15 | 2.4 |
| DECT | CP0805A1890EW | 1880 ÷ 1900 | 5±1 | 3.15 | 2.4 |
| Wireless LAN | CP0805A2442EW | 2400 ÷ 2484 | 4±1 | 4.2 | 2.4 |

Type: B
Sub-Type: A

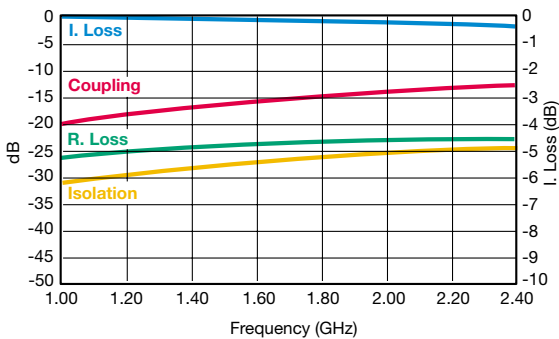

LAYOUT

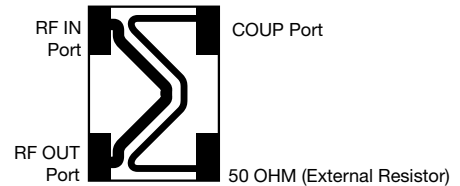

| APPLICATION | P/N | FREQUENCY BAND [MHz] | COUPLING [dB] | I. LOSS max | VSWR max |
|--------------|---------------|----------------------|---------------|-------------|----------|
| AMPS | CP0805B0836AW | 824 ÷ 849 | 21.5±1 | 0.25 | 1.2 |
| | CP0805B0881AW | 869 ÷ 894 | 21±1 | | |
| GSM | CP0805B0902AW | 890 ÷ 915 | 21±1 | 0.25 | 1.2 |
| | CP0805B0947AW | 935 ÷ 960 | 20.5±1 | | |
| E-GSM | CP0805B0897AW | 880 ÷ 915 | 21±1 | 0.25 | 1.2 |
| | CP0805B0942AW | 925 ÷ 960 | 20.5±1 | | |
| PDC | CP0805B1441AW | 1429 ÷ 1453 | 17±1 | 0.3 | 1.2 |
| PCN | CP0805B1747AW | 1710 ÷ 1785 | 15.5±1 | 0.3 | 1.2 |
| | Cp0805B1842AW | 1805 ÷ 1880 | 15.5±1 | | |
| PCS | CP0805B1880AW | 1850 ÷ 1910 | 15±1 | 0.3 | 1.2 |
| | CP0805B1960AW | 1930 ÷ 1990 | 14.5±1 | | |
| PHP | CP0805B1907AW | 1895 ÷ 1920 | 15±1 | 0.3 | 1.2 |
| DECT | CP0805B1890AW | 1880 ÷ 1900 | 15±1 | 0.3 | 1.2 |
| Wireless LAN | CP0805B2442AW | 2400 ÷ 2484 | 13±1 | 0.4 | 1.2 |

Thin-Film Directional Couplers



Layout Types

LAYOUT

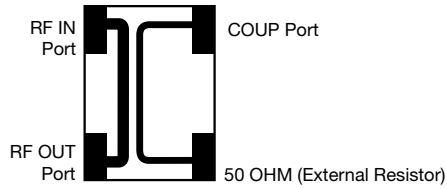

Type: B
Sub-Type: B

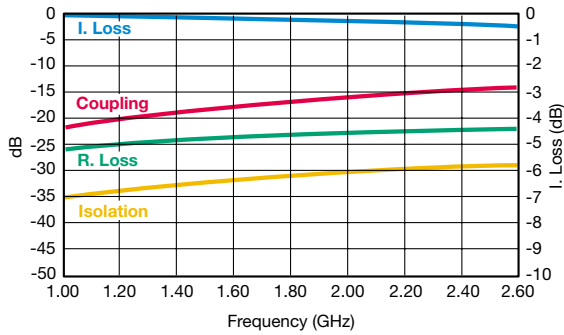

LAYOUT

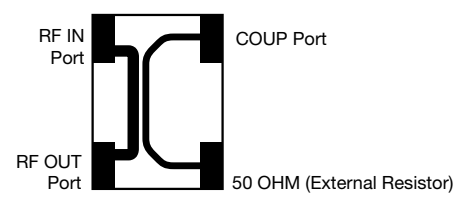

Type: B
Sub-Type: C

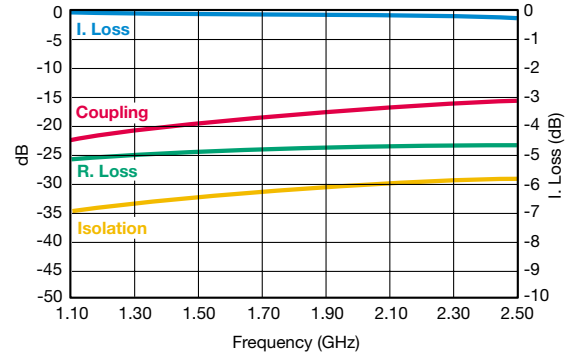

| APPLICATION | P/N | FREQUENCY BAND [MHz] | COUPLING [dB] | I. LOSS max | VSWR max |
|--------------|---------------|----------------------|---------------|-------------|----------|
| AMPS | CP0805B0836BW | 824 ÷ 849 | 23.5±1 | 0.25 | 1.2 |
| | CP0805B0881BW | 869 ÷ 894 | 23±1 | | |
| GSM | CP0805B0902BW | 890 ÷ 915 | 22.5±1 | | |
| | CP0805B0947BW | 935 ÷ 960 | 22±1 | | |
| E-GSM | CP0805B0897BW | 880 ÷ 915 | 23±1 | | |
| | CP0805B0942BW | 925 ÷ 960 | 22±1 | | |
| PDC | CP0805B1441BW | 1429 ÷ 1453 | 18.5±1 | | |
| PCN | CP0805B1747BW | 1710 ÷ 1785 | 17±1 | | |
| | CP0805B1842BW | 1805 ÷ 1880 | 16.5±1 | | |
| PCS | CP0805B1880BW | 1850 ÷ 1910 | 16.5±1 | | |
| | CP0805B1960BW | 1930 ÷ 1990 | 16±1 | | |
| PHP | CP0805B1907BW | 1895 ÷ 1920 | 16±1 | | |
| DECT | CP0805B1890BW | 1880 ÷ 1900 | 16±1 | | |
| Wireless LAN | CP0805B2442BW | 2400 ÷ 2484 | 14±1 | 0.4 | |

| APPLICATION | P/N | FREQUENCY BAND [MHz] | COUPLING [dB] | I. LOSS max | VSWR max |
|--------------|---------------|----------------------|---------------|-------------|----------|
| AMPS | CP0805B0836CW | 824 ÷ 849 | 25±1 | 0.25 | 1.2 |
| | CP0805B0881CW | 869 ÷ 894 | 24.5±1 | | |
| GSM | CP0805B0902CW | 890 ÷ 915 | 24±1 | | |
| | CP0805B0947CW | 935 ÷ 960 | 24±1 | | |
| E-GSM | CP0805B0897CW | 880 ÷ 915 | 24.5±1 | | |
| | CP0805B0942CW | 925 ÷ 960 | 24±1 | | |
| PDC | CP0805B1441CW | 1429 ÷ 1453 | 20±1 | | |
| PCN | CP0805B1747CW | 1710 ÷ 1785 | 18.5±1 | | |
| | CP0805B1842CW | 1805 ÷ 1880 | 18.5±1 | | |
| PCS | CP0805B1880CW | 1850 ÷ 1910 | 18±1 | | |
| | CP0805B1960CW | 1930 ÷ 1990 | 17.5±1 | | |
| PHP | CP0805B1907CW | 1895 ÷ 1920 | 18±1 | | |
| DECT | CP0805B1890CW | 1880 ÷ 1900 | 18±1 | | |
| Wireless LAN | CP0805B2442CW | 2400 ÷ 2484 | 16±1 | 0.4 | |

Thin-Film Directional Couplers



Test Jig

ITF TEST JIG FOR COUPLER 0805 AND 0603

GENERAL DESCRIPTION

This jig is designed for the testing of CP0805 and CP0603 series Directional Couplers using a vector network analyzer. It consists of a FR4 multi-layer substrate, having 50Ω microstrips as conducting lines and a ground plane in the middle layer, located at a distance of 0.2mm from the microstrips.

The connectors are SMA type (female), 'Johnson Components Inc.' Product P/N: 142-0701-881.

The jig is designed for a full 2-port calibration. LOAD calibration can be done either by a 50Ω SMA termination, or by soldering a 50Ω chip resistor at the 50Ω ports.

MEASUREMENT PROCEDURE

When measuring a component, it can be either soldered or pressed by a non-metallic stick until all four ports touch the appropriate pads. To measure the coupling (and the R. Loss) place the component on the Port 1 & Port 2 pads. Use two SMA 50Ω terminations (male) to terminate the ports, which are not connected to the network analyzer, and connect the network analyzer to the two ports. A 90° rotation of the component on its pads allows measuring a second parameter (I. Loss).

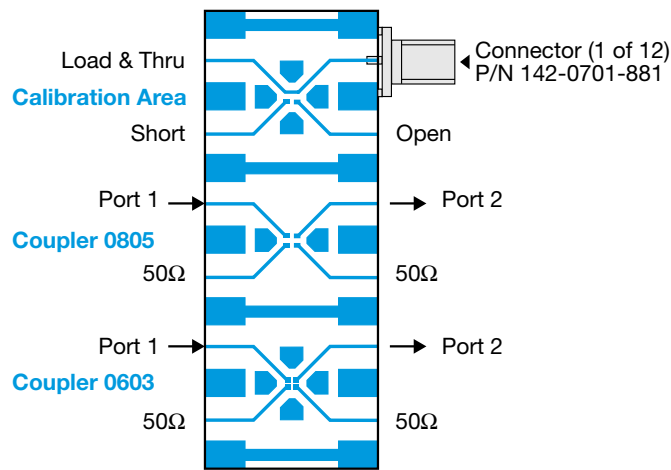

CP0805 SERIES DIRECTIONAL COUPLERS

Orientation and Tape and Reel Packaging Specification

(Top View)

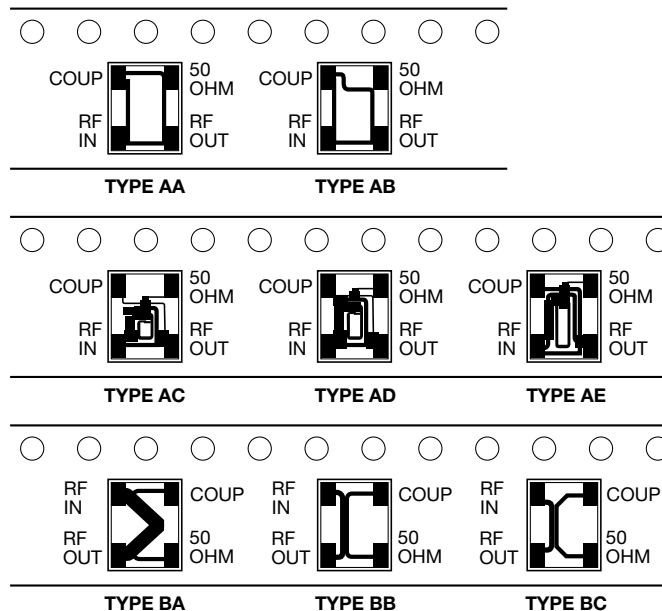

The parts should be mounted on the PCB with White (Alumina) side down and the "dark" side up.

