

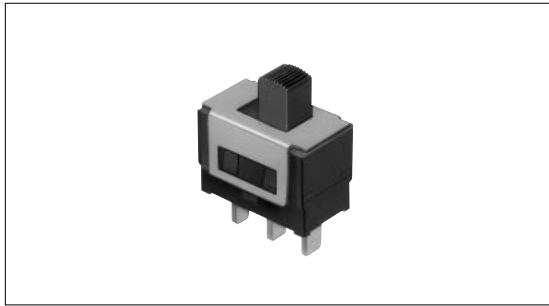

A 2.2mm-travel slide type with soft and light switch feel.



Ratings and Safety Standards

Items	Specifications
Ratings	6A 125V AC

Product Line

Circuit arrangement	Travel (mm)	Operating force	Mounting method	Minimum order unit (pcs.)	Product No.
SPDT	2.2	0.98 to 3.92N	PC board	100	SDKTA20100

Dimensions

Unit:mm

Style	PC board mounting hole dimensions

Circuit Diagram

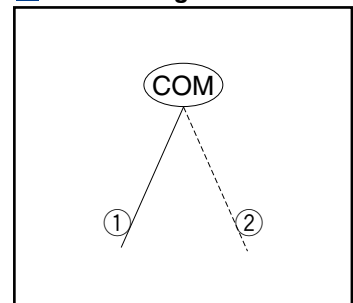

Circuit Arrangement

A side	B side
COM-①	COM-②

Note

Please place purchase orders per minimum order unit(integer).

Detector

Push

Slide

Rotary

Encoders

Power

Dual-in-line
Package Type

TACT Switch™

Custom-
Products





Push
Type

Rocker
Type

**Slide
Type**

Rotary
Type

List of Varieties

Items	Type	Slide				Rotary		
	Series	SDKG	SDKH	SDKP	SDKT	SDKZ		
Detector	Photo							
Push								
Slide	Travel (mm)	6			2.2	Full rotation		
Rotary	Remark					With signal circuit		
Encoders	Operating temperature range	-10 to +60				-10 to +70		
Power	Rating	5A 250V AC			6A 125V AC	PS:16(6)A 250V AC, 14(6)A 250V AC DC:0.1A 12V DC		
Dual-in-line Package Type	Electrical performance	Contact resistance	50m max.		100m max.		10m max.	100m max.
TACT Switch™			500M min. 500V DC		100M min. 500V DC	500M min. 500V DC	1,000M min. 500V DC	1 max.
Custom-Products		Insulation resistance	500M min. 500V DC			100M min. 500V DC	500M min. 500V DC	100M min. 100V DC
	Voltage proof	2,000V AC for 1minute			1,000V AC for 1minute	2,000V AC for 1minute 100V AC for 1minute		
	Mechanical performance	Terminal strength	10N for 1minute				20N 5N	
Push Type		Actuator strength	Operating direction		50N	30N	—	
Rocker Type			Perpendicular direction				10N	30N
Slide Type		Resistance to soldering heat	Manual soldering		350 ± 10 , 3 ± 0.5s		350 ± 10 , 3 ± 0.5s	
Rotary Type	Dip soldering		260 ± 5 , 10 ± 1s					
	Durability	Operating life	100cycles		20,000cycles	10,000cycles 30,000cycles		
			Without load		Load : As ratings			
	Environmental performance	Cold	-20 ± 2 for 96h			-40 ± 2 for 240h		
		Dry heat	85 ± 2 for 96h			85 ± 2 for 240h		
		Damp heat	40 ± 2 , 90 to 95%RH for 96h			40 ± 2 , 90 to 95%RH for 240h		
	Page	227	229	230	231	232		