

KENWOOD

KDC-V7090R
KDC-7090R

CD-RECEIVER
INSTRUCTION MANUAL

KENWOOD CORPORATION

B64-1902-00 (EN)



Contents

| | |
|---------------------------------|----------|
| Safety precautions | 3 |
|---------------------------------|----------|

| | |
|-------------------------------------|----------|
| Handling Compact discs | 6 |
|-------------------------------------|----------|

General features

| | |
|----------------------------------|----|
| Power | 8 |
| Switching Modes | 8 |
| Volume | 9 |
| Attenuator | 9 |
| Loudness | 10 |
| System Q | 10 |
| Speaker Setting | 10 |
| TEL Mute | 10 |
| Faceplate Angle Adjustment | 11 |
| Forced Closing | 11 |
| Removing the Faceplate | 12 |
| Clock display | 12 |

Audio control features

| | |
|-------------------------------|----|
| Audio Control Setting | 13 |
| Bass Centre Frequency | 14 |
| Bass Level | 14 |
| Bass Quality Factor | 14 |
| Bass Extend | 14 |
| Middle Centre Frequency | 14 |
| Middle Level | 14 |
| Middle Quality Factor | 14 |
| Treble Centre Frequency | 14 |
| Treble Level | 14 |
| Balance Level | 15 |
| Fader Level | 15 |
| Volume Offset | 15 |

Tuner features

| | |
|-----------------------------------|----|
| Tuning | 16 |
| Direct Access Tuning | 16 |
| Station Preset Memory | 16 |
| Switching Display for Tuner | 17 |

RDS features

| | |
|-------------------------------------|----|
| RDS (Radio Data System) | 18 |
| Enhanced Other Network | 18 |
| Alarm | 18 |
| Traffic Information Function | 18 |
| Presetting Volume for | |
| Traffic Information/News | 19 |
| Radio Text Scroll | 19 |
| Programme Type (PTY) Function | 20 |
| Changing Language for | |
| Programme Type(PTY) Function | 21 |

CD/External disc control features

| | |
|---|----|
| Playing CDs | 22 |
| Playing Other Disc mode | 22 |
| Switching Display for Discs | 22 |
| Fast Forwarding and Reversing Disc Play | 23 |
| Track Search | 23 |
| Disc Search | 24 |
| Direct Track Search | 24 |
| Direct Disc Search | 24 |
| Track / Disc Repeat | 24 |
| Track Scan | 25 |
| Presetting Disc Names (DNPS) | 26 |
| Random Play | 27 |
| Magazine Random Play | 27 |
| Disc Name Preset Play (DNPP) | 28 |
| Text / Title Scroll | 28 |

Menu settings

| | |
|---|----|
| Menu System | 29 |
| Mask Key | 30 |
| Touch Sensor Tone | 30 |
| Manual Time Adjustment | 30 |
| Automatic Time Adjustment | 31 |
| Selectable Illumination | 31 |
| Switching Graphic Display | 31 |
| Variable Illumination Colour Setting | 32 |
| Contrast Adjustment | 32 |
| Dimmer | 32 |
| Time setting for removing the faceplate | 33 |
| System Q | 33 |
| External Amp Control | 33 |
| News Bulletin Function | |
| with PTY News Timeout Setting | 33 |
| Local Seek Function | 33 |
| Selecting Tuning Mode | 34 |
| Auto Memory Entry | 34 |
| AF (Alternative Frequency) Function | 34 |
| Restricting RDS Region | |
| (Region Restrict Function) | 34 |
| Auto TP Seek Function | 35 |
| Monaural Reception | 35 |
| Text Scroll | 35 |
| Power OFF Timer | 35 |

Basic Operations of remote control...36

Installation

| | |
|---|----|
| Accessories | 39 |
| Installation Procedure | 39 |
| Connecting Cables to Terminals | 40 |
| Installation | 41 |
| Removing the Unit | 42 |
| Locking the faceplate to the unit | 43 |

Troubleshooting Guide44

Specifications48

Safety precautions

▲WARNING

To prevent injury and/or fire, take the following precautions:

- Insert the unit all the way until it is fully locked in place. Otherwise it may fly out of place during collisions and other jolts.
- When extending the ignition, battery or ground cables, make sure to use automotive-grade cables or other cables with an area of 0.75mm² (AWG18) or more to prevent cable deterioration and damage to the cable coating.
- To prevent short circuits, never put or leave any metallic objects (e.g., coins or metal tools) inside the unit.
- If the unit starts to emit smoke or strange smells, turn off the power immediately and consult your Kenwood dealer.
- Make sure not to get your fingers caught between the faceplate and the unit.
- Be careful not to drop the unit or subject it to strong shock.
The unit may break or crack because it contains glass parts.
- Do not touch the liquid crystal fluid if the LCD is damaged or broken due to shock. The liquid crystal fluid may be dangerous to your health or even fatal.
If the liquid crystal fluid from the LCD contacts your body or clothing, wash it off with soap immediately.

▲CAUTION

To prevent damage to the machine, take the following precautions:

- Make sure to ground the unit to a negative 12V DC power supply.
- Do not open the top or bottom covers of the unit.
- Do not install the unit in a spot exposed to direct sunlight or excessive heat or humidity. Also avoid places with too much dust or the possibility of water splashing.
- Do not subject the faceplate to excessive shock, as it is a piece of precision equipment.
- When replacing a fuse, only use a new one with the prescribed rating. Using a fuse with the wrong rating may cause your unit to malfunction.
- To prevent short circuits when replacing a fuse, first disconnect the wiring harness.
- Do not place any object between the faceplate and the unit.
- During installation, do not use any screws except for the ones provided. The use of improper screws might result in damage to the main unit.
- Do not apply excessive force to the moving faceplate. Doing so will cause damage or malfunction.
- Do not apply excessive force to the open faceplate or place objects on it. Doing so will cause damage or breakdown.

IMPORTANT INFORMATION

About the disc changer to be connected:

To connect a disc changer having the "O-N" switch to this unit, set the "O-N" switch to "N".

When you connect a model with no "O-N" switch, the converter cord CA-DS100 available as an option may be required. For details, consult your Kenwood dealer. If a model with no "O-N" switch is connected, some unavailable functions and information that cannot be displayed are generated, such as the DNPS, DNPP, Magazine random play, and CD Text display. Note that none of the KDC-C100, KDC-C302, C205, C705, and non-Kenwood CD changers can be connected.

▲CAUTION

You can damage both your unit and the CD changer if you connect them incorrectly.

Do Not Load 8-cm (3-in.) CDs in the CD slot

If you try to load an 8-cm CD with its adapter into the unit, the adapter might separate from the CD and damage the unit.

Safety precautions

NOTE

- If you experience problems during installation, consult your Kenwood dealer.
- If the unit fails to operate properly, press the RESET button. The unit returns to factory settings when the RESET button is pressed. After you press the reset button, the Mask Key will be needed to restart the unit. If the unit still fails to operate properly after the RESET button has been pressed, contact your local KENWOOD dealer for assistance.
- Press the reset button if the CD auto changer is first controlled and operates incorrectly. The original operating condition will return.

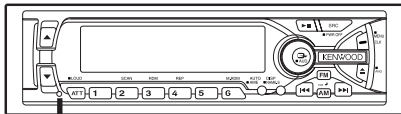

Reset button

- Characters in the LCD may become difficult to read in temperatures below 41 °F (5 °C).

- The illustrations of the display and the panel appearing in this manual are examples used to explain more clearly how the controls are used. Therefore, what appears on the display in the illustrations may differ from what appears on the display on the actual equipment, and some of the illustrations on the display may represent something impossible in actual operation.
- The functions that can be used and the information that can be displayed will differ depending on the external disc players being connected.

Mask key

If you have transmitted the Mask Key's signal once to the unit in advance, you will have to transmit it once again if the unit has been removed from the battery. This function helps prevent theft.

When using the unit for the first time:
In order to deactivate the demonstration mode, be sure to press the transmit button to transmit the Mask Key's signal. If this procedure is not carried out, the control panel of the unit will re-open in two seconds even with your vehicle's ignition turned off.

CAUTION

Do not lose the "Mask Key".
If power is disconnected from the unit, correct operation can only be restored by the "Mask Key's" signal.
The "Mask Key" will also be required for service repair.

NOTE

If you send products in for repair that include a mask key, make sure to present the unit together with the mask key.

Cleaning the Faceplate Terminals

If the terminals on the unit or faceplate get dirty, wipe them with a dry, soft cloth.

Cleaning the Unit

If the faceplate of this unit is stained, wipe it with a dry soft cloth such as a silicon cloth. If the faceplate is stained badly, wipe the stain off with a cloth moistened with neutral cleaner, then wipe neutral detergent off.

▲ CAUTION

Applying spray cleaner directly to the unit may affect its mechanical parts. Wiping the faceplate with a hard cloth or using a volatile liquid such as thinner or alcohol may scratch the surface or erase characters.

Cleaning the CD Slot

As dust can accumulate in the CD slot, clean it occasionally. Your CDs can get scratched if you put them in a dusty CD slot.

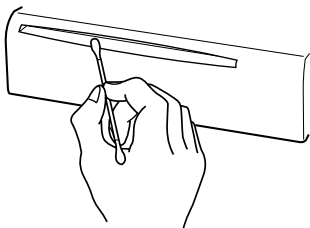

The marking of products using lasers (Except for some areas)

**CLASS 1
LASER PRODUCT**

The label is attached to the chassis/case and says that the component uses laser beams that have been classified as Class 1. It means that the unit is utilizing laser beams that are of a weaker class. There is no danger of hazardous radiation outside the unit.

Lens Fogging

Right after you turn on the car heater in cold weather, dew or condensation may form on the lens in the CD player of the unit. Called lens fogging, CDs may be impossible to play. In such a situation, remove the disc and wait for the condensation to evaporate. If the unit still does not operate normally after a whilst, consult your Kenwood dealer.

Handling Compact discs

Playing a CD that is dirty, scratched or warped can cause the sound to skip and the unit to operate incorrectly, resulting in worsened sound quality. Take the following precautions to prevent your CDs from getting scratched or damaged.

Handling CDs

- Do not touch the recorded side of the CD (i.e., the side opposite the label) when holding it.

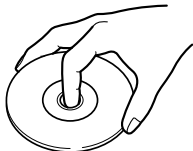

- The reflective film on a CD-R or a CD-RW is more fragile than that on an ordinary music CD, and may peel off if scratched. Fingerprints on a CD-R or CD-RW are also more likely to cause skipping when the disc is played. For these reasons, handle the disc very carefully. Detailed handling instructions will appear on the CD-R or CD-RW package: read this information carefully before using the disc.
- Do not stick tape on either side of the CD.

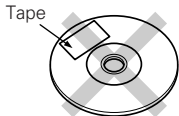

Storing CDs

- Do not store CDs in areas exposed to direct sunlight – such as a car seat or above the fascia panel (dashboard) – or other hot places. A CD-R or CD-RW is more susceptible than a music CD to damage from high temperatures and humidity, and in some cases, may become unusable if left in the car for long periods of time.
- Remove CDs from the unit when not listening to them for a whilst, and put them back in their cases. Do not stack CDs that have been removed from their cases or prop them against something.

Cleaning CDs

If a CD has become dirty, wipe it off gently using a commercially available cleaning cloth or a soft cotton cloth, starting from the centre of the disc and moving outward. Do not clean CDs with conventional record cleaners, anti- static formulas, or chemicals such as paint thinner or benzene.

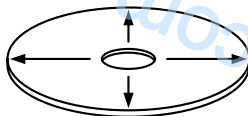

Checking New CDs for Burrs

When playing a new CD for the first time, check that there are not any burrs stuck to the perimeter of the disc or in the central hole. CDs with burrs stuck on them may not load properly or may skip whilst playing. Remove burrs using a ballpoint pen or a similar utensil.

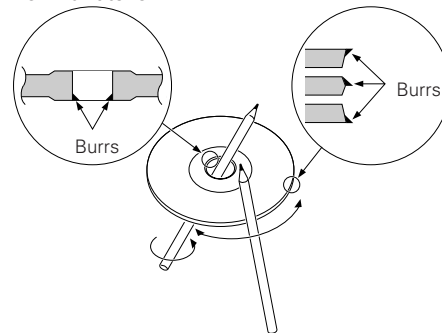

Do Not Load CD Accessories in Slot

Do not use commercially available CD accessories that can be loaded into the CD slot, such as stabilisers, protective sheets, or CD cleaning discs, since they can cause the unit to malfunction.

Removing the CD

Only remove the CD from the machine in a horizontal direction. You may damage the surface of the CD if you try pulling it down as it ejects.

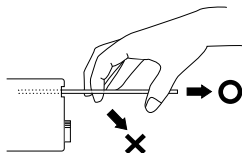

Do Not Use Special Shape CDs

- Be sure to use round shape CDs only for this unit and do not use any special shape CDs. Use of special shape CDs may cause the unit to malfunction.

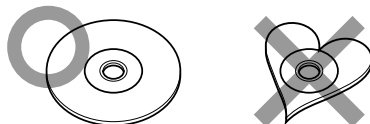

- Be sure to use CDs with disc mark



only for this unit.

- CD-Rs and CD-RWs which have not undergone finalization processing cannot be played. (For more information on finalization processing, refer to the manual for your CD-R/CD-RW writing software or CD-R/CD-RW recorder.) Additionally, depending on the recording status, it may prove impossible to play certain CDs recorded on CD-R or CD-RW.

Do Not Use CDs with Sticker on the Labelled Side

Do not use the CD with the label sticker stuck on it.

Using such a CD may cause the CD to be deformed and the sticker to peel off, resulting in malfunction of the unit.

General features

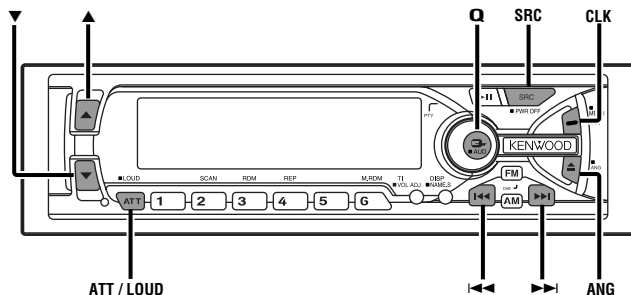

KDC-V7090R

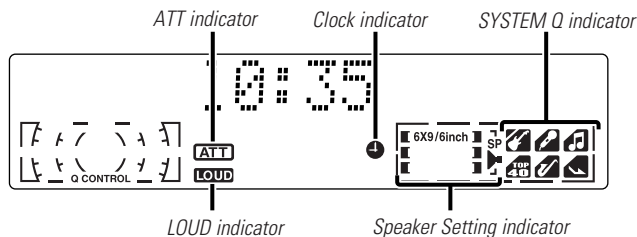

KDC-7090R

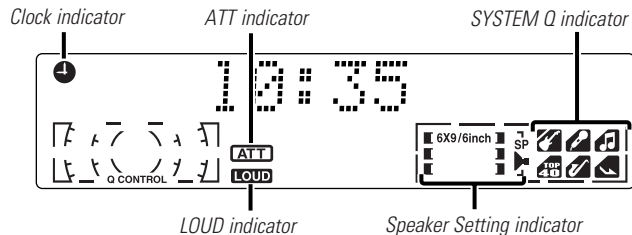

Power

You can help prevent theft of the unit by reversing the faceplate so that the control panel cannot be seen, hiding the unit, and shutting off the audio.

Power ON/OFF:

When you turn your vehicle's ignition on, the unit's power will also turn on, with the faceplate reversing to show the control panel.

When you turn your vehicle's ignition off, the faceplate will reverse to hide the control panel after a period of time which you have set in the "Time setting for removing the faceplate" in the menu. The unit's power will turn off.

Alternatively, you can remove the faceplate during that period. For details, refer to the "Removing the faceplate" (page 12).

NOTE

- After installation of your Mask unit, be sure to transmit the Mask Key's signal to deactivate the demonstration mode. If this procedure is not carried out, the control panel of the unit will re-open in two seconds even with your vehicle's ignition turned off.
- When the moving faceplate is hit by an object, it will stop and return to its original state. Remove the object and repeat the action.

CAUTION Using the Unit in Vehicles with Covered Consoles

- Make sure the console is uncovered whilst the faceplate is reversed.
- Do not exert any excess force on the movable parts of the unit, including the faceplate, as it can cause failure in the unit's mechanism.

Switching Modes

Switching Modes:

Each time you press the SRC button, the mode switches as follows:

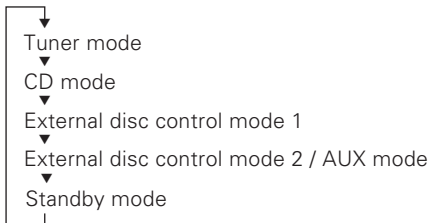

Selecting the standby mode:

Press the SRC button repeatedly to select to "ALL OFF". When "ALL OFF" is displayed, the standby mode is turned on. The standby mode turns all functions off although leaving the unit's power on. Use this mode when you want to have the display illuminated but do not want to listen to anything.

NOTE

- The mode switches to the next mode from any mode which cannot be used.
- The external disc control mode will differ depending on the unit that is connected.
- To enable the selection of External disc control mode 2/AUX mode, you should connect optional switching adapter KCA-S210A (which allows you to select both External disc control mode 2 and AUX mode) or CD changer (KDC-CPS87, KDC-CX87, KDC-CPS85, KDC-CX85, KDC-CPS82 or KDC-CX82) or switching adapter CA-C1AX (which allows you to select AUX mode only).
During the AUX mode, "AUX" (or AUX-name display) will show in the display. When the CA-C1AX is being used, the AUX Mode will replace the External Disc Control Mode.
- If you have selected Standby mode, the timer function that turns the power off automatically will be activated.
To find out how to set the time on the timer, and how to cancel the timer function, refer to the section on the Power Off Timer function under Menu settings (page 35)

NOTE

Selecting AUX-name display
Holding down the DISP button for two seconds or more during the AUX mode, AUX-name display is blinked for AUX-name selection mode.

Pressing ◀◀ or ▶▶ button during this mode allows you to select "AUX", "TV", "VCP", "GAME" or "PORTABLE" in the AUX mode. The AUX-name selection mode can be exited by pressing the DISP button or doing nothing for 10 seconds.

Volume

Increasing Volume:

Press the ▲ button to turn up the volume.

Decreasing Volume:

Press the ▼ button to turn down the volume.

Attenuator

This function allows you to turn down the volume quickly.

Turning Attenuator On/Off:

Press the ATT button to switch the attenuator on and off.

When the attenuator is on, the ATT indicator blinks.

When the attenuator is off, the volume returns to the original level.

NOTE

Turning the volume up, or turning it all the way down deactivates the attenuator function.

General features

Loudness

This function amplifies low and high tones when the volume is turned down.

The LOUD indicator lights up, when the loudness function is on.

Turning Loudness On/Off:

Hold down the LOUD button for one second or more to switch the loudness on and off.

System Q

You can recall the best audio setting preset for different types of the music.

Switching the Preset Sound Setting:

Each time you press the Q button, the preset sound setting switches as follows:

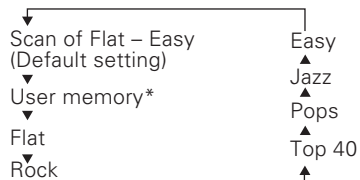

*User memory:
The unit returns to the state adjusted the last time with the audio control setting feature.

As you proceed, each indicator would go on.

NOTE

The System Q function changes the values of the following sound quality parameters:
Bass centre frequency, bass level, bass quality factor, bass extend, middle centre frequency, middle level, middle quality factor, treble centre frequency, and treble level.
Their setting values are different depending on the setting of the speaker setting mode.

Speaker Setting

This function allows you to adjust the setting that is recalled with the System Q, according to types of speakers.

- 1 Press the SRC button repeatedly to select the standby mode. "ALL OFF" is displayed when the standby mode is selected.
- 2 Press the Q button to enter the speaker setting mode.
- 3 Press either the ◀◀ or ▶▶ button to select the type of speaker. The setting switches as follows.
Off ("SP OFF") / For 6/6x9 in. speaker ("SP 6*9/6inch") / For 5/4 in. speaker ("SP 5/4inch") / For the OEM speaker ("SP O.E.M.")
- 4 Press the Q button to end the speaker setting mode.

NOTE

Speaker setting function allows for tuning of bass, middle and treble

TEL Mute

Shut down the audio system temporarily whenever an incoming call is received.

NOTE

The function will not work if a cable is not connected to the car phone.

When the telephone rings:

When a call is received, "CALL" is displayed and all the unit functions are temporarily interrupted.

Restoring Original Unit Source During Phone Call:

Press the SRC button.
"CALL" disappears from the display, and the volume of the original source is restored gradually.

Turning TEL Mute Function Off After Phone Call:

Hang the phone up.
"CALL" disappears from the display.

The original source (i.e., the one used before the phone call) is returned to automatically, and the volume restored gradually.

NOTE

- When the closing faceplate is hit by an object, the unit will turn off without the faceplate closing all the way. Remove the object and press the SRC button to turn the unit back on, then turn it off again to make it close properly.
- Do not try to press the buttons on the control panel as the faceplate is moving, as excessive force may damage the unit.
- During the forced closing of the unit (i.e., having the unit left closed whilst ignition is turned on), the faceplate will not open no matter how often the ignition is turned on or off. You can prevent tampering of the unit when letting someone else drive your car by keeping it closed this way.

To cancel the forced closing of unit and open control panel:

Press the left part at the upper side of the faceplate. The faceplate will open and show the control panel.

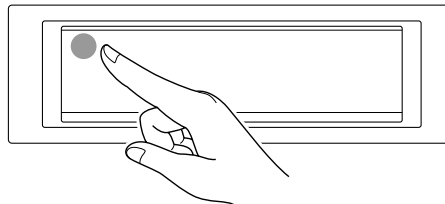

Faceplate Angle Adjustment

You can adjust the faceplate angle for easy viewing.

Sliding the faceplate:

Hold down the ANG button for one second or more.

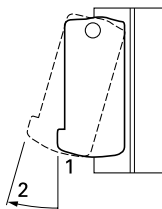

NOTE

Do not apply excessive force to the faceplate under setting 2.

Forced Closing

This function prevents tampering with the unit your car is being serviced etc.

Hiding the unit with the ignition turned on (forced closing):

Hold down the SRC button for one second or more. The faceplate will slide open. When the period of time which you have set in the "Time setting for removing the faceplate" in the menu has passed, the faceplate automatically reverses to hide the control panel. However, you can remove the faceplate during that period. For details, refer to the "Removing the faceplate" (page 12).

General features

Removing the Faceplate

The faceplate can be detached from the unit, helping to deter theft.

Removing the faceplate:

- 1 Choose the way from among the following and open the faceplate.
Turn the ignition off, hold down the SRC button for one second or more when the control panel has been hidden.
- 2 Holding the centre part of the faceplate, pull it out during the period which you have set in the "Time setting for removing the faceplate" (page 33) in the menu.
The faceplate bracket will automatically close.

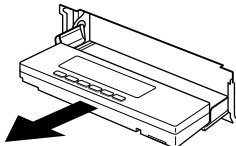

CAUTION

- When removing the faceplate, pull it out only when it is fully open. The detachment of the faceplate whilst it is moving might result in damage to the unit.
- Do not apply excessive force to the faceplate bracket without attaching the faceplate. Doing so will cause the faceplate bracket to be deformed.
- Do not touch the connector on the faceplate bracket after removing the faceplate. Touching the connector may cause damage to the unit.

NOTE

- The faceplate is a precision piece of equipment and can be damaged by shocks or jolts. For that reason, keep the faceplate in its special storage case whilst detached.
- Do not expose the faceplate or its storage case to direct sunlight or excessive heat or humidity. Also avoid places with too much dust or the possibility of water splashing.

Reattaching the Faceplate:

- 1 Hold the faceplate so that the control panel faces the front toward you and set the left side of the faceplate in the faceplate bracket.

CAUTION

Do not set the right side of the faceplate in the faceplate bracket first, when reattaching the faceplate. Doing so may cause the connector on the faceplate bracket to malfunction.

- 2 Press the right side of the faceplate until it locks.

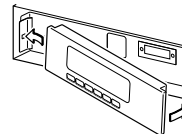

Clock display

Changing the Clock Display:

Press the CLK button to switch the clock display on and off.

NOTE

The clock indicator lights whilst the clock is displayed.

Audio control features

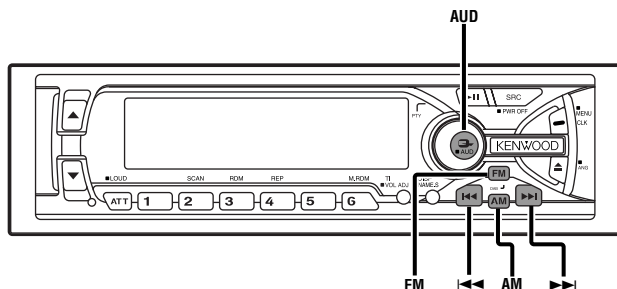

KDC-V7090R

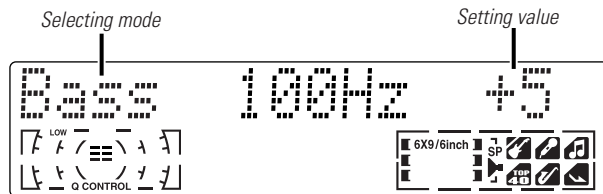

KDC-7090R



Audio Control Setting

Adjust various parameters of sound quality.

1 Hold down the AUD button for one second or more to enter the control mode.

2 **Selecting mode**

Press either the FM or AM button.

Each time the button is pressed, the adjustment mode will change.

Please refer to the following for the contents of the adjustment modes.

NOTE Source tone memory

Each source (CD, FM, AM, and disc changer) has its own memory in which to store the bass, middle, and treble tone settings.

The settings made for a particular source are then recalled automatically whenever you use that source (e.g., FM mode uses the tone settings made for FM, AM for AM, etc.).

3 **Adjust each mode**

Press the ◀◀/▶▶ button.

Please refer to the following for the adjusting values.

4 Press the AUD button to end the control mode.

NOTE

- Determining the parameters in the audio control setting will clear all the adjustments made in the System Q and they are replaced with the values made in the audio control setting.
- The following parameters can be set when the System Q function on the menu settings is ON. Bass centre frequency, bass quality factor, bass extend, middle centre frequency, middle quality factor, and treble centre frequency.

Audio control features

Bass Centre Frequency

Adjust the centre frequency of the bass.

Display and setting:

"Bass FRQ"/"Bass F" : 60 / 70 / 80 / 100 (Only when the bass quality factor is set to 1.00, 1.25 or 1.50) / 150 (Only when the bass quality factor is set to 2.00) Hz.

Bass Level

Adjust the bass level.

Display and setting:

"Bass" : - 8 - + 8

Bass Quality Factor

Adjust the Bass quality factor.

Display and setting:

"Bass Q" : 1.00 / 1.25 / 1.50 / 2.00

Bass Extend

Switch the Bass Extend mode on/off.

Display and setting:

"Bass EXT" : ON / OFF (When the bass extend mode is set to on, low frequency response is extended by 20%.)

Middle Centre Frequency

Adjust the centre frequency of the middle.

Display and setting:

"MID FRQ"/"MID F" : 0.5 / 1.0 / 1.5 / 2.0 kHz

Middle Level

Adjust the middle level.

Display and setting:

"MID"/"Middle" : - 8 - + 8

Middle Quality Factor

Adjust the middle quality factor.

Display and setting:

"Middle Q" : 1.0 / 2.0

Treble Centre Frequency

Adjust the centre frequency of the treble.

Display and setting:

"TRE FRQ"/"TRE F" : 10.0 / 12.5 / 15.0 / 17.5 kHz

Treble Level

Adjust the treble level.

Display and setting:

"TRE"/"Treble" : - 8 - + 8

Balance Level

Adjust the balance level.

Display and setting:

"Balance" : Left 15 – Right 15

Fader Level

Adjust the fader level.

Display and setting:

"Fader" : Rear 15 – Front 15

Volume Offset

Set the sound level of the each source selected by adjusting the level difference between the basic sound level and the required level.

Display and setting:

"VOL Offset"/"V Offset" : - 8 – ± 0

Tuner features

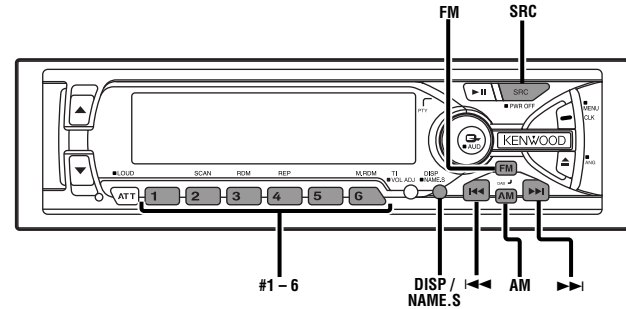

KDC-V7090R

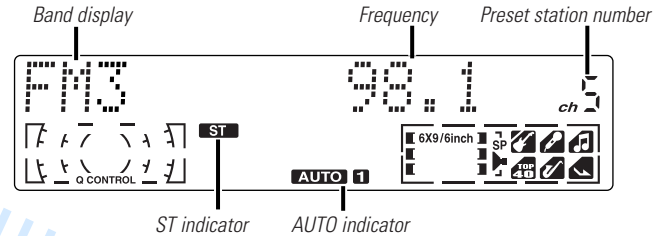

KDC-7090R

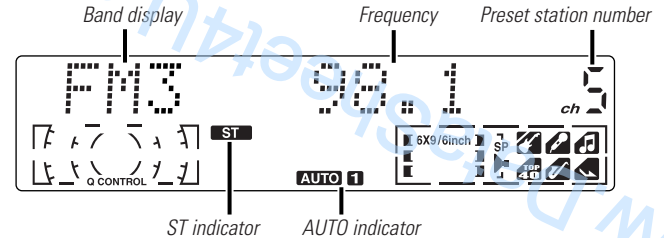

Tuner features

Tuning

- 1 Press the SRC button repeatedly until the tuner mode is obtained. "TUNER" is displayed only when the tuner mode is selected.
- 2 Press either the FM or AM button to select the band. Each time you press the FM button, the band switches between the FM1, FM2 and FM3. Press the AM button to select the MW and LW bands.
- 3
 - Auto Seek Tuning
Press the ►► button to seek increasing frequencies. Press the ◀◀ button to seek decreasing frequencies.
 - Preset station seek tuning
Press the ►► button to move to the next preset station (i.e., the one with the next highest number), and the ◀◀ button to move to the last preset station (i.e., the one with the next lowest number).

NOTE

If the frequencies stored at the preset numbers receive stations which were not originally memorized when travelling long distances, the preset number is not displayed. In such cases, pressing the ◀◀/►► button to use preset station seek will receive channel 1.

- Manual Tuning
Press the ►► button to increase the frequency by one step. Press the ◀◀ button to decrease the frequency by one step.

NOTE

- The ST indicator lights up when stereo broadcasts are being received.
- Please see the menu settings about selecting tuning mode. (page 34)

Direct Access Tuning *(Function of remote control)*

When you know the frequency of the station that you want to listen to, you can input it directly for quick access.

- 1 Select the band by pressing the FM or AM button.
- 2 Press the DIRECT button.
"----" is displayed for 10 seconds.
If you make no input in the 10-second period, direct access tuning is automatically cancelled.
- 3 Enter the frequency of the desired station.
If you want to listen to an FM station at 92.1 MHz, for example, press 0, 9, 2, and 1.
If you want to listen to an AM station at 810 kHz, for example, press 0, 8, 1, and 0.

NOTE

- You cannot enter frequencies above or below what a band can receive.
- FM frequencies can only be input in 0.1 MHz steps, and not 0.01MHz steps.

Canceling Direct Access Tuning:

Press the DIRECT button again.

Station Preset Memory

Store the frequency of the station currently being listened to. You can then recall that station with a single touch of a button.

- 1 Select the band/station that you want to have stored.
- 2 Hold down the button (#1-6) that you want to use for the station, for two seconds or more.
The button number blinks once in the display to indicate that the data has been stored.

Recalling a Preset Station:

Press the preset station button (#1-6) for the desired station. The number of the recalled station is displayed.

NOTE

You can store 6 stations in each of the FM1, FM2, FM3, and AM (MW and LW) bands.

RDS features

Switching Display for Tuner

You can change the display used when listening to the radio.

Switching the Display:

Each time you press the DISP button, the display changes as follows:

- Programme Service name (only during RDS station reception)/ Station frequency
- Radio text (only during RDS station reception)

Displaying Frequencies during programme service name display:

Hold down the DISP button for one second or more. The frequency for the RDS station will be displayed for five seconds instead of the station name.

NOTE

If the RDS station currently tuned to is transmitting no text whilst the Radio Text Display mode is turned on, "NO TEXT" will appear in the display. Whilst awaiting reception, "Waiting" will be displayed.

WARNING

To prevent accidents, drivers should not look at the display whilst driving.

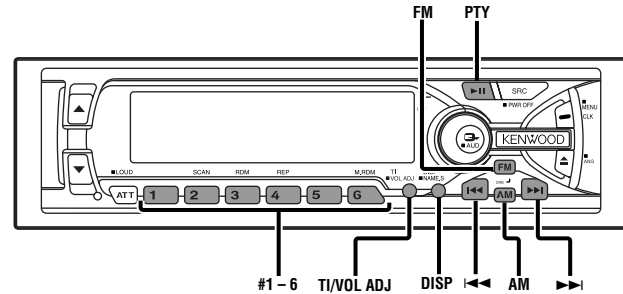

KDC-V7090R

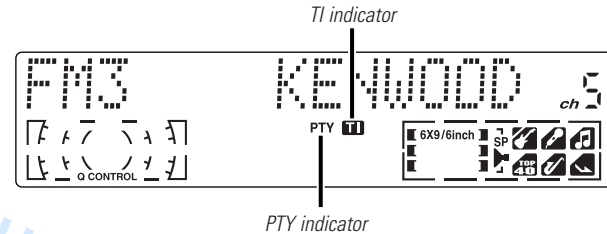

KDC-7090R

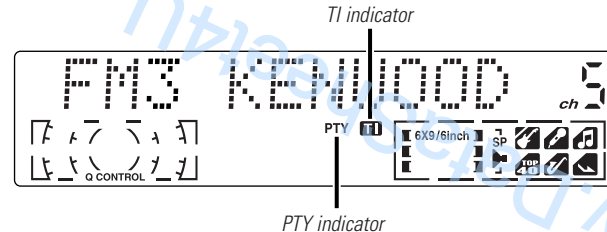

RDS features

RDS (Radio Data System)

RDS is a digital information system that lets you receive signals besides those of regular radio programmes, such as network information being transmitted from radio stations. When listening to an RDS station (ie, a station with RDS capability), the programme service name of the station is displayed along with the frequency, advising you quickly which station is being received.

RDS (Radio Data System) stations also transmit frequency data for the same station. When you are making long trips, this function automatically switches to the particular frequency with the best reception for the particular network of stations that you want to listen to. The data is automatically stored, allowing you to switch quickly to another RDS stations, broadcasting the same programme, that has better reception. These include stations stored in the station preset memory that you often listen to.

Enhanced Other Network

Stations that offer <Enhanced Other Network> also transmit information about other RDS stations that have traffic information. When you are tuned to a station that is not transmitting traffic information, but another RDS station starts transmitting a traffic bulletin, the tuner automatically switches to the other station for the duration of the bulletin.

Alarm

When an emergency transmission (announcing disasters, etc.) is sent, all current functions are interrupted to allow the warning to be received.

Traffic Information Function

You can listen to traffic information. If you are listening to tapes or discs, they will continue playing until a traffic bulletin is broadcast.

Turning TI function On/Off:

Press the TI button to turn the function on and off.

When the function is on, the TI indicator is turned on.

When none is being received, the TI indicator will blink on and off. When a traffic information station is being received, the TI indicator will turn on.

When a traffic bulletin begins to be broadcast, "Traffic Info" will be displayed, and reception will begin at the preset volume.

If you are listening to a tape or disc when a traffic bulletin begins, they will automatically be turned off. When the bulletin ends or poor reception is experienced, the tape or disc will begin playing again.

NOTE

Pressing the TI button whilst in the MW/LW band automatically switches reception to the FM band. However, the MW/LW band is not returned to when the TI button is pressed again.

Switching to a Different Traffic Information Station:

Use the ◀◀ / ▶▶ buttons to make an auto seek of the TI stations in a certain band.

NOTE

- When you are listening to a tape or disc, you cannot change to another TI station.
- When the auto TP seek function is turned on and reception starts to weaken, the tuner automatically seeks traffic information stations with better reception.
- If you are tuned to a station that is not a traffic information station itself but which provides <Enhanced Other Network> services, you can still have traffic information received.
- Holding down the TI button for one second or more when the TI function is on in the tape or disc mode results in a change to the frequency display of the traffic information station for five seconds.

Presetting Volume for Traffic Information/News

Preset the volume level to be used for traffic information and news broadcasts.

- 1 Tune into the station for which you want to set the volume.
- 2 Adjust the volume to the desired level.
- 3 Hold down the VOL ADJ button for two seconds or more. The volume level blinks once in the display to indicate that the data has been stored. Future traffic information/news broadcasts are heard at the preset level.

NOTE

- The volume cannot be lowered by this function during tuner reception. The volume is only set when it is louder than the listening volume of the tuner.
- You can arrange only to listen to traffic information or news bulletins with at preset volume with the volume set at minimum.

Radio Text Scroll

This function permits the text to be scrolled and the entire text to be displayed. The scrolling method differs depending on the setting of scrolling in the menu.

To scroll manually:

- 1 Press the DISP button to display the Radio Text.
- 2 Holding down the DISP button for one second or more results in one scrolling display of the text.

To scroll automatically:

- 1 Press the DISP button to display the Radio Text. The text will be displayed in one scrolling display.
- 2 Holding down the DISP button for one second or more results in one scrolling display of the text.

NOTE

Please see the menu settings (page 35) about switching between manual scrolling and automatic scrolling.

RDS features

Programme Type (PTY) Function

Conduct auto seek tuning only on those stations with selected kinds of programmes.

1 Press the PTY button.

"PTY" is displayed, and the Programme Type Selection (PTY) Mode entered.

If you make no key input in 30 seconds, the mode will automatically turn off.

NOTE

You cannot use this function whilst the traffic bulletin is received.

2 Select the type of programme to be received

- Press either the FM or AM button repeatedly until the type of programme you want to listen to.

The selection includes:

| | |
|---------------------------|------------|
| <i>Speech</i> | (Speech) |
| <i>Music</i> | (Music) |
| 1. News | (News) |
| 2. Current Affairs | (Affairs) |
| 3. Information | (Info) |
| 4. Sports | (Sport) |
| 5. Education | (Educate) |
| 6. Drama | (Drama) |
| 7. Culture | (Culture) |
| 8. Science | (Science) |
| 9. Varied | (Varied) |
| 10. Pop Music | (Pop M) |
| 11. Rock Music | (Rock M) |
| 12. Easy Listening Music | (Easy M) |
| 13. Light Classical | (Light M) |
| 14. Serious Classical | (Classics) |
| 15. Other Music | (Other M) |
| 16. Weather | (Weather) |
| 17. Finance | (Finance) |
| 18. Children's programmes | (Children) |
| 19. Social Affairs | (Social) |
| 20. Religion | (Religion) |
| 21. Phone In | (Phone In) |
| 22. Travel | (Travel) |
| 23. Leisure | (Leisure) |

| | |
|--|------------|
| 24. Jazz Music | (Jazz) |
| 25. Country Music | (Country) |
| 26. National Music | (Nation M) |
| 27. Oldies Music | (Oldies) |
| 28. Folk Music | (Folk M) |
| 29. Documentary | (Document) |
| (Speech.....1~9,16~23, 29, Music.....10~15, 24~28) | |

- You can select the type of programme directly by pressing a preset button. The buttons are factory-set to the following type of programmes:

| | | |
|-----------------|----------------------|-----------|
| 1. <i>Music</i> | 2. <i>Speech</i> | 3. News |
| 4. Other Music | 5. Serious Classical | 6. Varied |

NOTE

Changing the Preset Button Settings for Programme Type
After selecting the type of programme to be stored in a certain preset button, hold down that button for two seconds or more. The previously stored data for that button are erased and the new programme type is stored.

3 Seeking the selected programme type

Press the ◀◀ or ▶▶ button to make a seek of frequencies with your selected type of programme.
The display blinks and the seek starts.

If your selected type of programme is found, the name of the station is displayed and the station is tuned into.

"PTY Found" is display for about 30 seconds.

If you make no key input in 30 seconds, the PTY selection mode will turn off automatically.

NOTE

If no programme can be found, "NO PTY" is displayed.
If you want to select another type of programme, repeat steps 2 and 3 above.

Switching to Other Stations with the Same Type of Programme:

When "PTY Found" in the display, perform auto seek tuning.
The tuner scans for another station with the same type of programme.

Cancelling Programme Type Function During Its Operation:

Press the PTY button.

Changing Language for Programme Type(PTY) Function

Changing the display language to another language.

- 1 Press the PTY button.
"PTY" is displayed, and the Programme Type Selection (PTY) Mode entered.
- 2 **Enter the Changing Language Mode**
Press the DISP button to enter the changing language mode.
- 3 **Changing the Display Language**
Press the FM or AM button.
Each time the button is pressed, the display language will change as follows:

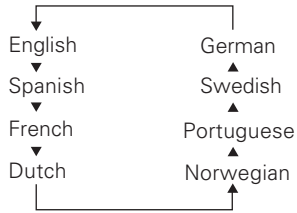

- 4 Press the DISP button to end the changing language mode.

CD/External disc control features

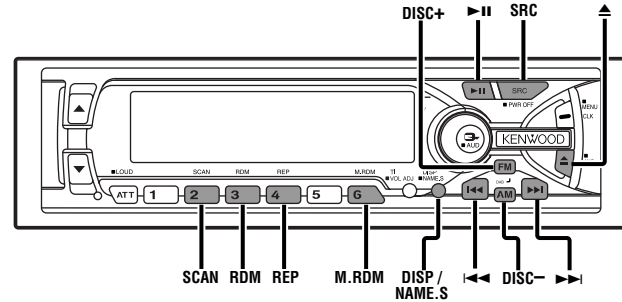

KDC-V7090R

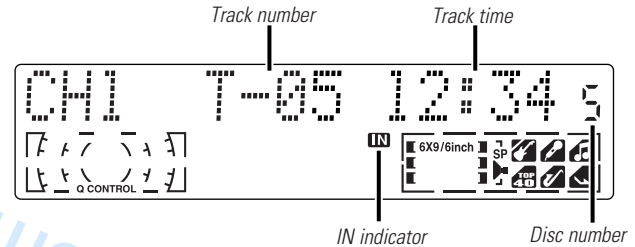

KDC-7090R

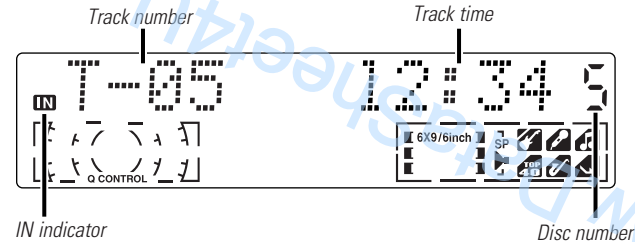

CD/External disc control features

Playing CDs

Playing CDs:

Press the ▲(EJECT) button to slide open the faceplate, showing the CD (insertion) slot. Holding the CD with the labeled side facing up, insert it in the slot.

The faceplate will close, and the CD will start playing. The IN indicator will light when a CD has been inserted.

Playing CDs Already Inserted:

Press the SRC button repeatedly until the CD mode is obtained. "CD" is displayed when the CD mode has been selected.

The CD will start playing.

Pausing and Restarting CD Play:

Press the ►|| button to make the disc pause.

Press the same button again to start play again.

Eject:

Press the ▲(EJECT) button. The faceplate will slide to eject the CD.

Press the ▲(EJECT) button to close the faceplate.

CAUTION

- Do not attempt to insert a CD into the slot if another one is already there.
- The unit can only play 12-cm (5-inch) CDs. If you insert an 8-cm (3-inch) CD, it will get stuck inside and can cause the unit to malfunction.
- When the faceplate has been slid open, it might interfere with the gear lever or something else. If this happens, pay attention to safety and move the gear lever or take an appropriate action, then operate the unit.

NOTE

- The sound will be temporarily muted whilst the faceplate is moving.
- When you load a CD and eject it right away, the next time you try to insert the CD may not load. In such a situation, take the CD out for a moment and then reinsert it.

Playing Other Disc mode

This function permits the connection of optional players and the playing of discs other than the loaded CD (in the current unit).

Playing Discs:

Press the SRC button repeatedly to select the external disc control mode.

The disc will start playing.

NOTE

The external disc control mode will differ, depending on the unit that is connected.

Mode Display Examples

- "CD2" ...when a CD player is connected
- "DISC" ...when a disc changer is connected
- "DISC1" , "DISC2" ...when two disc changers are connected

Pausing and Restarting Disc Play:

Press the ►|| button to make the disc pause.

Press the same button again to start play again.

NOTE

- When one disc has finished playing its last track, the next disc in the changer starts playing. When the last disc in the changer has finished, the player returns to the first disc and starts playing it.
- Disc #10 is displayed as "0".

Switching Display for Discs

Switch the display that appears whilst discs are playing.

Switching Display for Discs:

Each time you press the DISP button, the display during disc play switches as follows:

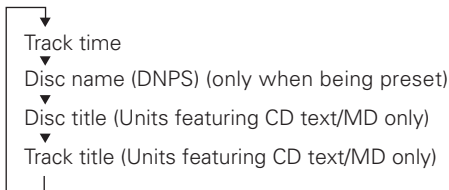

NOTE

- You can give names to discs through the presetting disc name function (page 26).
Note that depending on the unit, display may not be possible.
- If you try to display the name of a disc that does not have one, "NO NAME" is displayed instead.
- When there is an attempt to display the title of a disc for which the disc title/track title has not been recorded, "NO TEXT" is displayed for CD and "NO TITLE/NO NAME" is displayed for MD.
- Depending on the type of characters of the CD Text, some characters may not be displayable.
- If you attempt to display disc title/track title when connecting the CD changer not supported for CD text feature, caution messages such as "NO TEXT" or "Reading" may be displayed.

Fast Forwarding and Reversing Disc Play

Fast Forwarding Disc Play:

Hold down on the ►► button.
Release your finger to play the disc at that point.

Reversing Disc Play:

Hold down on the ◀◀ button.
Release your finger to play the disc at the point.

NOTE

You cannot use reverse play between tracks depending on the model being connected. Instead, the reverse play function is cancelled when it reaches the beginning of a track, at which point normal play automatically resumes.

Track Search

Search forwards or backwards through the tracks on the disc until you reach the one that you want to listen to.

Making a Reverse Track Search:

Press the ◀◀ button to display the desired track number.
Press once to search back to the beginning of the current track, twice to search back to the beginning of the previous track, and so forth.
Play starts at the beginning of the displayed track number.

NOTE (For disc changers)

Pressing the ◀◀ button whilst listening to track 1 only searches back to the beginning of that track. The reverse search is not "recycled" to the last track on the disc.

Making a Forward Track Search:

Press the ►► button to display the desired track number.
Press once to fast forward to the next track, twice to fast forward to the track after that, and so forth.
Play starts at the beginning of the displayed track number.

NOTE (For disc changers)

You cannot make a forward track search when listening to the last track on a disc.

CD/External disc control features

Disc Search

(Function of disc changers)

Search forwards or backwards through the discs in a disc changer until you reach the one that you want to listen to.

Making a Reverse Disc Search:

Press the DISC— button to display the desired disc number. Each time the button is pressed, the displayed disc number decreases by one.

Play starts at the beginning of the displayed disc.

Making a Forward Disc Search:

Press the DISC+ button to display the desired disc number. Each time the button is pressed, the displayed disc number increases by one.

Play starts at the beginning of the displayed disc.

NOTE

"Load" is displayed when discs are being exchanged on the disc changer.

Direct Track Search

(Function of remote control)

Using the remote control, make direct input of the track number that you want to listen to.

1 Using the numeric buttons on the remote control, enter the number of the track that you want to listen to. The selected track number blinks in the display for 10 seconds. If you make no further input in the 10-second period, the number entry mode will automatically be cancelled.

2 Press either the ◀◀ or ▶▶ button whilst the track number is blinking. The track specified in step 1 starts playing.

Cancelling Direct Track Search During Its Operation:

Press the ▶|| button.

NOTE

You cannot use the direct track search function during random play or magazine random play.

Direct Disc Search

(Function of disc changers with remote control)

Using the remote control, make direct input of the disc number that you want to listen to.

1 Using the numeric buttons on the remote control, enter the number of the disc that you want to listen to. The selected disc number blinks in the display for 10 seconds. If you make no further input in the 10-second period, the number entry mode will automatically be cancelled.

NOTE

- Input "0" to select disc #10.
 - If you enter more than two numbers all at once, a search will be made only of the last number entered.
 - You cannot use the direct disc search function during random play or magazine random play.
- 2 Press either the DISC+ or DISC— button whilst the number inputted is blinking. The disc specified in step 1 starts playing.

Cancelling Direct Disc Search During Its Operation:

Press the ▶|| button.

Track / Disc Repeat

Repeat playing the current track or disc.

Turning Repeat Play Function On/Off:

Press the REP button to switch the repeat play function on and off as follows :

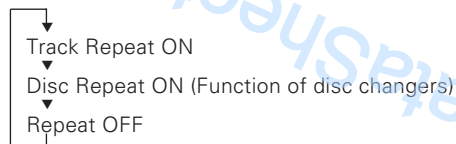

"Repeat ON" / "T-Repeat ON" is displayed and the track

number blinks in the display when track repeat is on.
"Disc Repeat ON" / "D-Repeat ON" is displayed and the disc number blinks in the display when disc repeat is on.

NOTE

Repeat play is cancelled when you eject the disc.

Track Scan

Successively play the beginning of each track on a disc until you find the track that you want to listen to.

Starting the Track Scan:

Press the SCAN button. "Scan ON" is displayed and the first 10 seconds of each track are played, and the tracks are played in order.

The track number currently being heard blinks in the display.

Stopping to Listen to the Track Being Scanned:

Press the ►|| or SCAN button again to stop the scan and keep on listening to a track normally.

NOTE

- The track scan function is cancelled when you eject the disc.
- The track scan function only scans each track on a disc once.

CD/External disc control features

Presetting Disc Names (DNPS)

Store the names of discs to be displayed when played.

- 1 Play the disc whose name you want to preset.

NOTE

- This function is not available for disc changers that do not feature the Disc Name Preset function.
 - The disc name preset function cannot be used when the Magazin random play and disc title or track title is displayed.
- 2 Hold down the NAME.S button for two seconds or more. "NAME SET" is displayed and the disc name preset mode is entered.
The cursor blinks in the position where character input can be made.
 - 3 Press either the ◀◀ or ▶▶ button to move the cursor to the desired position.
The ◀◀ button moves the cursor to the left, and the ▶▶ button to the right.
You can also move the cursor left or right by pressing the ◀◀ or ▶▶ buttons, respectively, on the remote control.
 - 4 Each time the ▶▶ button is pressed, the characters to be entered change as listed below.
Press the DISC+ or DISC- button to display the desired character.
Characters that can be displayed are as follows.

Alphabet (upper case): A ~ Z

Alphabet (lower case): a ~ z

Numerals and symbols: 0~9 @ " ' ` % & * + = , . / \ < > []

Special characters: á â é ê ì í ó ò ú û ñ ç \$ % & ' () * + , - . / : ; < > ? [\] ^ _ ` { | } ~ ¡ ¢ £ ¤ ¥ ¦ § ¨ © ª « ¬ ® ¯ ° ± ² ³ ´ µ ¶ · ¸ ¹ º » ¼ ½ ¾ ¿

NOTE

Direct Alphabet Input

(Function of remote control with number/letter entry buttons)

If the disc changers that were manufactured and sold after 1997 (except for KDC-C560) are connected, you can directly input letters using the number/letter entry buttons on the remote control.

Example: Use the following table to enter the name "DANCE".

| Character | Button to press | # Times pressed |
|-----------|-----------------|-----------------|
| "D" | #3 | 1 |
| "A" | #2 | 1 |
| "N" | #6 | 2 |
| "C" | #2 | 3 |
| "E" | #3 | 2 |

- 5 Continue steps 3 and 4 until all the characters are chosen for the name.

NOTE

You can enter up to 12 characters for each name.

- 6 Press either the NAME.S button on the main unit or the OK button on the remote control.
The disc name is stored and the disc name preset mode is cancelled.
If you make no entry in a 10-second period, the name will be stored with the characters input so far.

NOTE

- The number of discs whose names can be stored will differ depending on the disc changer that is connected. Please see your disc changer manual for details.
Up to 30 CDs can be registered with this unit.
- Discs are identified by their total length and number of tracks. If another disc happens to have the same specifications as one that you have already stored a name for, the name will be displayed for it, too.
- If you want to change the name of a disc, repeat steps 1 and 2 to display the name, and then repeat steps 3 and 4 to input the changes.
- Pressing the reset button erases the disc names stored in this unit, but does not erase the names stored in a disc changer.

Random Play

Play all the tracks on the current disc in random order.

- 1 Press the RDM button to switch the random play function on and off.

"Random ON" is displayed when random play is turned on. The display of the track number changes continuously as the next track is being selected.

When the track has been selected, play starts.

The selected track number blinks in the display as it is being played.

NOTE (For disc changers)

When all the tracks on a certain disc have been played using the random play function, the next disc on the changer starts playing (with the random play function still turned on).

- 2 To change the track being heard, press the ►► button. Another track is selected and played.

NOTE

Random play is cancelled when you eject the disc.

NOTE

- Magazine random play is cancelled when you eject the disc.
- The time needed for random selection depends on the number of discs loaded in the disc magazine.

Magazine Random Play *(Function of disc changers)*

Play the tracks on all the discs in the disc changer in random order.

- 1 Press the M.RDM button to switch the magazine random play function on and off.

"M.Random ON" is displayed when magazine random play is turned on.

The display of the disc and track numbers change continuously as the next track is being selected.

When the disc/track has been selected, play starts.

The selected disc/track number blinks in the display as it is being played.

- 2 To change the track being heard, press the ►► button. Another disc/track is selected and played.

CD/External disc control features

Disc Name Preset Play (DNPP)

(Function of Remote Control)

If you have preset the name of a disc that you want to listen to in the disc changer, you can look for it by name and start playing it.

- 1 Press the DNPP button on the remote control. "DNPP" will appear in the display, and the disc name preset play mode is entered. The names of all the discs in the disc changer will appear successively in the display for five seconds each. Discs whose names have not been preset will appear as "NO NAME" in the display.

NOTE

- This function can only be used in disc changers that were manufactured or sold as of 1997. Also note that some units cannot provide a display unless the disc name preset has been made by the unit that is playing.
- Discs in the disc changer that have never been played before will appear as "NO ACCESS" when the disc names are displayed. When you cannot identify a disc because of the "NO ACCESS" display after inserting a disc magazine, try playing it to display the disc name. Also note that "NO DISC" will be displayed when a disc has not been loaded.

Rapid display (forward / reverse):

Press the DISC+ or DISC- button.
Pressing the DISC+ button will rapidly display the preset names/disc titles in order.
Pressing the DISC- button will rapidly display the preset names/disc titles in reverse order.

2 When the name appears for the disc you want to play

Press the OK button.
The disc whose name is displayed will be recalled, and the disc name preset play (DNPP) mode will end.

To cancell DNPP mode:

Press the DNPP button.
The disc name preset play (DNPP) mode will be cancelled.

Text / Title Scroll

This function permits the text to be scrolled and the entire text to be displayed. The scrolling method differs depending on the setting of scrolling in the menu.

To scroll manually:

- 1 Press the DISP button to display the disc title or the track title.
- 2 Holding down the DISP button for one second or more results in one scrolling display of the titles.

To scroll automatically:

- 1 Press the DISP button to display the disc title or the track title. The titles will be displayed in one scrolling display.

NOTE

When the disc or track to be played changes, the title is displayed in one scrolling display.

- 2 Holding down the DISP button for one second or more results in one scrolling display of the titles.

NOTE

- Please see the menu settings (page 35) about switching between manual scrolling and automatic scrolling.
- You cannot use the text scroll function during magazine random play.

Menu settings

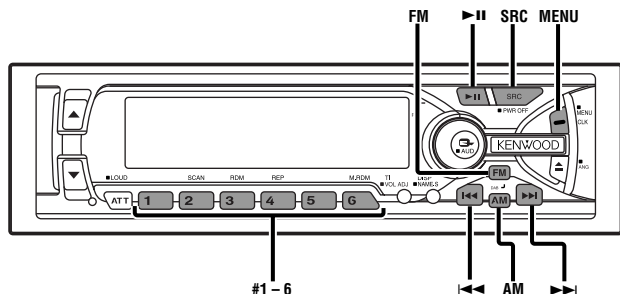

KDC-V7090R

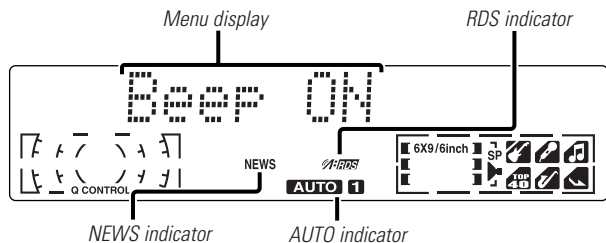

KDC-7090R

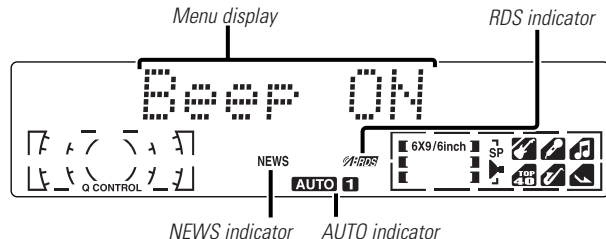

Menu System

You can set the defaults for additional functions in the menu mode. Make a setting for each function, referring to the following operations.

1 Enter the menu mode

Hold down the MENU button for one second or more. "MENU" is displayed when the menu mode is entered.

The function that you can adjust is indicated with the current settings displayed.

2 Selecting function to set

Press the FM button to search through the functions until you see the one you want to adjust in the display.

Press the AM button to search through the functions backward.

Function items change in the order of features that follow in the menu system.

Example: If you want to switch the setting of the touch sensor tone function from on to off, first search through the functions until you see "Beep ON" in the display.

3 Changing setting for currently displayed function

Press either the ◀◀ or ▶▶ button.

The setting will change for each function.

Example: The setting of the touch sensor tone will switch from on to off, and "Beep OFF" is displayed.

4 Ending the menu mode

Press the MENU button.

NOTE

Make sure to end the menu mode when finished.

If you fail to end the menu mode, several functions may not operate properly, including the Traffic Information function, the News Bulletin function with PTY news timeout setting, and the Alarm function.

Menu settings

Mask Key

If you have transmitted the Mask Key's signal once to the unit in advance, you will have to transmit it once again if the unit has been removed from the battery. This function helps prevent theft.

When using the unit for the first time:

In order to deactivate the demonstration mode, be sure to press the transmit button to transmit the Mask Key's signal. If this procedure is not carried out, the control panel of the unit will re-open in two seconds even with your vehicle's ignition turned off.

- 1 Press the SRC button repeatedly to select the standby mode. "ALL OFF" is displayed when the standby mode is selected.
- 2 Hold down the MENU button for one second or more. "MENU" is displayed and "Mask key" appears in the display.
- 3 Hold down either the ◀◀ or ▶▶ button for one seconds or more. "TRANSMIT 1" will appear in the display, indicating the setting mode has been entered.
- 4 Hold down the transmit button on the Mask key until the full transmit level indicator lights up in the display. "TRANSMIT 2" will be displayed.

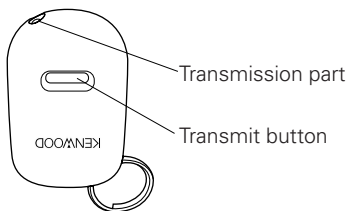

NOTE

- Keep the Mask Key close to the signal sensor when you transmit the Mask Key's signal.
- If the Mask Key's signal does not be received correctly, the display will return to "TRANSMIT 1". In this case, repeat the

procedure in step 4.

- 5 Hold down the transmit button on the Mask key again until the full transmit level indicator lights up in the display. "APPROVED" will appear in the display, with the Mask key function turning on.

If you press the RESET button or remove the battery:

The first time you turn the unit on again, "TRANSMIT 1" will appear in the display, indicating the setting mode has been entered. Repeat steps 4 and 5 above, and transmit the signal. You can start operating the unit again when "APPROVED" appears in the display.

Touch Sensor Tone

This function produces a beep sound that accompanies button operation. It can be switched on or off.

Display and setting:

"Beep ON" : Beep setting is on. (Default setting)

"Beep OFF" : Beep setting is off.

NOTE

The beep sound is not output from the preout jacks.

Manual Time Adjustment

Adjust the time manually.

NOTE

This adjustment is available only when the automatic time adjustment is set to off. (page 31)

Display and setting:

- 1 Select the display "Clock Adjust" during the selecting function in the menu system.
- 2 Hold down either the ◀◀ or ▶▶ button for one second or more to enter the Manual time adjustment mode.

The time display will blink.

- 3 • Adjusting the hours
Press the FM button to advance the hours, or press the AM button to make the hours go back.
- Adjusting the minutes
Press the ►► button to advance the minutes, or press the ◀◀ button to make the minutes go back.
- 4 Press the MENU button to end the Manual Time Adjustment mode.
Exiting the Manual Time Adjustment mode would start the clock counting.

Automatic Time Adjustment

With automatic time adjustment, you can set the clock time automatically according to time data sent from RDS stations (after receiving RDS signals for several minutes). You can also set the time manually if the automatic time adjustment function is turned off.

Display and setting:

"SYNC ON" : Automatic time adjustment (Default setting)

"SYNC OFF" : Manual time adjustment

Adjusting Time Automatically:

Tune into an RDS station for 3 or 4 minutes.

The time adjusts automatically to the correct local time.

NOTE

The time is not adjusted when the RDS station you are tuned to is not transmitting a time signal. Choose another RDS station in such a case.

Selectable Illumination

You can switch the colour of the button illumination between green and red.

Display and setting:

"Button Green" : The colour of the illumination is green.

"Button Red" : The colour of the illumination is red.

Switching Graphic Display

This function allows you to turn off the lower part of the display if there is too much information in the display.

Display and setting:

"Graphic ON" : The display will turn on by using the whole part of the display. (Default setting)

"Graphic OFF" : The display will turn on by using only the upper part of the display and the IN indicator

www.DataSheet4U.com

Menu settings

Function of the KDC-V7090R

Variable Illumination Colour Setting

You can set the display to a desired colour.

Display and setting:

- 1 Select the display "Color" during the selecting function in the menu mode.
- 2 **To set a colour manually:**
Hold down on the ◀◀ or ▶▶ button.
Pressing the ▶▶ button advances the colour, and pressing the ◀◀ button reverses it.
When the desirable colour is appeared, release the button.
- 3 **To make the popular colours appear:**
Press the preset button(#1-4) for the desired color.
The buttons #1-4 are preset for the following four colours:
#1: White
#2: Red
#3: Blue
#4: Blue Green
- 4 **To switch colours depending on the situation: (Situational Mode)**

Each time you press the #6 button, the mode switches as follows:

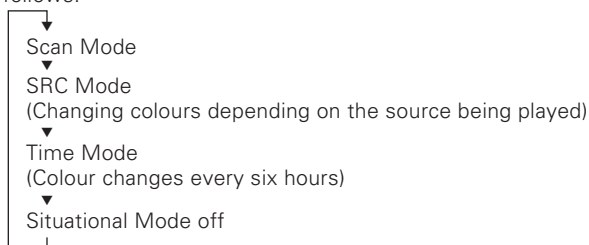

When the Situational Mode is off, the original colour setting resumes.

- 5 **To finely adjust blue: (Blue Adjust Mode)**
Press the #3 button for two seconds or more to enter the

blue adjust mode.

The ◀◀ and ▶▶ buttons are used to adjust the blue color tones, respectively.

Press the #3 button to end the blue adjust mode.

6 To store the colour setting in the memory: (colour preset memory)

After adjusting the illumi colours, press the #5 button for two seconds to store the colour setting in the memory.

Pressing the #5 button again recalls the stored colours from the memory.

NOTE

Blue Adjust mode setting can't do memory

- 7 Press the MENU button to end the Variable Illumination Colour Setting mode.

Contrast Adjustment

This adjustment permits easy viewing of the display.

Display and setting:

"Contrast 0" – "Contrast 10"

NOTE

The initial setting value is "5".

Dimmer

You can dim the display.

NOTE

The dimmer function is not available for units if the dimmer cable is not connected.

Display and setting:

"Dimmer ON" : The dimmer setting is on. (Default setting)

"Dimmer OFF" : The dimmer setting is off.

Time setting for removing the faceplate

You can set the interval during which the open control panel cannot reverse to be hidden. During the period you have set, the faceplate can be removed from the faceplate bracket.

Display and setting:

"Off Wait" : 0s / 3s (Default setting) / 5s / 10s / 15s / 20s / 25s
(s=seconds)

System Q

When this system is set to on, the System Q factors (Bass centre frequency, Bass quality factor, Bass extend, Middle centre frequency, Middle quality factor, and Treble centre frequency) appear during the audio control mode.

Display and setting:

"System Q ON" : The System Q factors appear and can be adjusted. (Default setting)

"System Q OFF" : The System Q factors do not appear.

External Amp Control

Adjust the bass boost level of the external amplifier using the main unit.

Display and setting:

"AMP Bass FLT" : Bass boost level is flat. (Default setting)

"AMP Bass +6" : Bass boost level is low (+6dB).

"AMP Bass +12" : Bass boost level is high (+12dB).

NOTE

As of December 2000, the power amplifiers controllable by the main unit are as follows:
KAC-X501F/PS501F/X401M/PS401M/X301T/PS301T/X201T/PS201T

News Bulletin Function with PTY News Timeout Setting

You can arrange to have news bulletins interrupt your current listening source, including other radio stations. When the News Bulletin function is on, the PTY News Timeout setting allows you to set the interval during which further news interruption cannot take place. You can adjust the PTY news interruption period from 10 to 90 minutes for each journey.

Display and setting:

"News OFF" (Default setting) , "News 00min" - "News 90min"
(min= minutes)

: When you select the news interruption timeout interval, the News function turns on and the NEWS indicator lights up.

When a news bulletin is received, "News" will be displayed and reception will begin at the preset volume.

NOTE

- If you choose the "20min" setting, further news bulletins will not be received for 20 minutes once the first news bulletin is received.
- This function is only available if the desired station sends PTY-code for news bulletin or belongs to <Enhanced Other Network>-Network sending PTY-code for news bulletin.
- If you turn on the news bulletin function in the MW/LW band, the band is switched automatically to the FM band. However, the MW/LW band is not returned to when you turn off the function.

Local Seek Function <In Tuner mode>

With the local seek function turned on, auto seek tuning skips stations with relatively poor reception.

Display and setting:

"Local.S ON" : The local seek function is on.

"Local.S OFF" : The local seek function is off. (Default setting)

Menu settings

Selecting Tuning Mode <In Tuner mode>

You can choose from three tuning modes: auto seek, preset station seek, and manual. The "AUTO 1" indicator lights up when auto seek tuning is selected, and the "AUTO 2" indicator lights when preset station seek tuning is selected.

Display and setting:

"Auto 1" : Auto seek tuning mode (Default setting)

"Auto 2" : Preset station seek tuning mode

"Manual" : Manual tuning mode

Auto Memory Entry <In Tuner mode>

You can automatically store all the receivable frequencies in the band currently being listened to, and then recall them with the touch of a button later. This function is especially useful when you are travelling and do not know what stations are available. Up to 6 frequencies can be stored this way.

Display and setting:

- 1 Select the display "Auto-Memory" during the selecting function in the menu system.
- 2 Hold down either the ◀◀ or ▶▶ button for two seconds or more to start auto memory function.
The numbers of the preset station buttons showed in order. When all the stations in a certain band are stored in the preset memory, the auto memory entry stops. The tuner then plays the last station received.

NOTE

- When the AF function is turned on whilst auto memory entry takes place, only RDS stations (i.e., stations with RDS capability) are stored. RDS stations that have been preset for FM1 cannot also be preset in FM2 or FM3.
- When the local seek function is turned whilst auto memory entry takes place, stations with poor reception are not stored.
- When the Traffic Information function is on, only the local traffic information station frequency will be stored.

Cancelling Auto Memory Entry During Its Operation:

Press the ◀◀/▶▶ button whilst auto memory entry is taking place to stop the process.

Recalling a Preset Station:

Press the preset station button (#1-6) for the desired station. The number of the recalled station is displayed.

AF (Alternative Frequency) Function

When poor reception is experienced, automatically switch to another frequency broadcasting the same programme in the same RDS network with better reception. The RDS indicator lights up when the AF function is turned on.

Display and setting:

"AF ON" : The AF function is on. (Default setting)

"AF OFF" : The AF function is off.

NOTE

When no other stations with stronger reception are available for the same programme in the RDS network, you may hear the incoming broadcast in bits and snatches. Turn off the AF function in such a case.

Restricting RDS Region (Region Restrict Function)

You can choose whether or not to restrict the RDS channels, received with the AF function for a particular network, to a specific region. When the Region Restrict Function is on, the region is restricted.

Display and setting:

"Regional ON" : The Region Restrict Function is on. (Default setting)

"Regional OFF" : The Region Restrict Function is off.

NOTE

Sometimes stations in the same network broadcast different programmes or use different programme service names.

Auto TP Seek Function

When the TI function is on and poor reception conditions are experienced when listening to a traffic information station, another traffic information station with better reception will be searched for automatically. This function is on, when unit is first powered on.

Display and setting:

"ATPS ON" : The Auto TP Seek Function is on.
If the traffic information station you are tuned to experiences poor reception, this function automatically seeks another TP station. (Default setting)

"ATPS OFF" : The Auto TP Seek Function is off.

Monaural Reception <In FM reception of Tuner mode>

When poor stereo reception is experienced, this function will reduce noise and improve listening conditions.

Display and setting:

"MONO ON" : The monaural reception is on.
"MONO OFF" : The monaural reception is off. (Default setting)

Text Scroll <In FM or External disc control mode>

This function permits the CD text, MD title, and Radio text to be scrolled and the entire text to be displayed. Switching between manual scrolling and automatic scrolling is permitted.

Display and setting:

"Scroll Auto" : Automatic scrolling
"Scroll Manual"/"Scroll MANU" : Manual scrolling (Default setting)

Power OFF Timer

Set the time for the OFF Timer function activated when you selected Standby mode.
If the predefined time elapses, this unit's power is automatically turned off.

Display and setting:

"OFF ----" : Power OFF Timer function is cancelled.
"OFF 20min" : Unit's power goes OFF after 20 minutes. (Default setting)
"OFF 40min" : Unit's power goes OFF after 40 minutes.
"OFF 60min" : Unit's power goes OFF after 60 minutes.

Basic Operations of remote control

Accessory of the KDC-V7090R

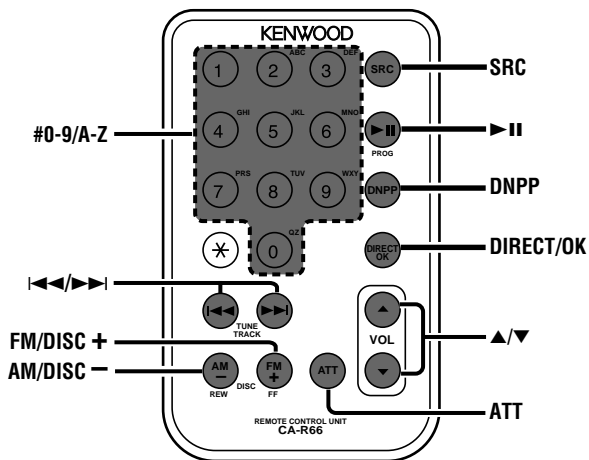

▲CAUTION

Do not set the remote control on hot places such as above the dashboard.

Loading and Replacing the Batteries:

Use one lithium battery (CR2025).

Remove the case following the instructions as illustrated.

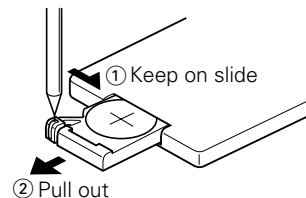

Insert the batteries with the + and - poles aligned properly, following the illustration inside the case.

▲WARNING

Store unused batteries out of the reach of children. Contact a doctor immediately if the battery is accidentally swallowed.

Basic operations

- **VOL buttons**
Press the ▲ button to turn the volume up.
Press the ▼ button to turn the volume down.
- **SRC button**
Each time you press the SRC button, the mode switches as follows:

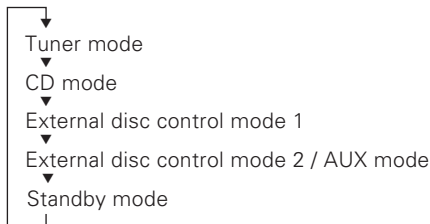

NOTE

- The mode switches to the next mode from any mode which cannot be used.
- The external disc control mode will differ depending on the unit that is connected.
- To enable the selection of External disc control mode 2/AUX mode, you should connect optional switching adapter KCA-S210A (which allows you to select both External disc control mode 2 and AUX mode) or CD changer (KDC-CPS87, KDC-CX87, KDC-CPS85, KDC-CX85, KDC-CPS82 or KDC-CX82) or switching adapter CA-C1AX (which allows you to select AUX mode only).
During the AUX mode, "AUX" (or AUX-name display) will show in the display.
When the CA-C1AX is being used, the AUX Mode will replace the External Disc Control Mode.
- If you have selected Standby mode, the timer function that turns the power off automatically will be activated.
To find out how to set the time on the timer, and how to cancel the timer function, refer to the section on the Power Off Timer function under Menu settings (page 35).
 - **ATT button**
Turns down the volume quickly. To return the volume to its original level, press the button again. Turning the volume up, or turning it all the way down deactivates the attenuator function.

Tuner features

- **◀◀/▶▶ buttons**
Press the ◀◀ button to make decreasing seeks (using the preset tuning mode).
Press the ▶▶ button to make increasing seeks (using the preset tuning mode).
- **AM/FM buttons**
Press the AM button to select the MW and LW bands.
Press the FM button to select and switch between FM1, FM2, and FM3 bands.
- **DIRECT/OK button**
Enters and cancels the Direct access tuning mode.
- **▶|| button**
Enters and cancels the Programme Type Selection (PTY) mode.
- **Number/letter entry buttons**
Press buttons #1-6 to recall preset stations.
Use to enter frequency of the desired station during Direct access tuning mode.

www.DataSheet4U.com

Basic Operations of remote control

Accessory of the KDC-V7090R

CD/External disc control features

- **◀◀/▶▶ buttons**
Press the ◀◀ button to search through the tracks backwards.
Press the ▶▶ button to search through the tracks forwards.
Used to move the cursor whilst entering disc name.
- **DISC buttons (for disc changers)**
Press the DISC- button to search through the discs backwards.
Press the DISC+ button to search through the discs forwards.
Selects numbers and symbols whilst entering disc name.
- **▶|| button**
When a disc is playing, this button pauses the play.
Press the same button again to start play again.
Selects the type of characters at the time of entering the disc name.
- **OK button**
During disc name input, stores the already input data in memory and ends the input mode.
Selects disc during the disc name preset play mode.
- **DNPP button (for disc changers)**
Enters and cancels the Disc Name Preset Play mode.
- **Number / letter entry buttons**
Used to specify the track (disc) number used in direct track (disc) searches.
Use to enter letters during disc name preset.

Accessories

External view

Number of items

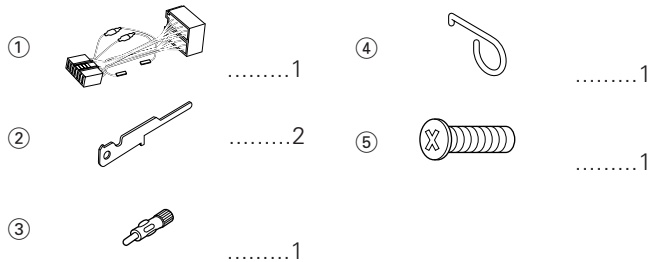

▲CAUTION

The use of any accessories except for those provided might result in damage to the unit. Make sure only to use the accessories shipped with the unit, as shown above.

Installation Procedure

1. To prevent short circuits, remove the key from the ignition and disconnect the ⊖ terminal of the battery.
2. Make the proper input and output cable connections for each unit.
3. Connect the cable on the wiring harness.
4. Take Connector B on the wiring harness and connect it to the speaker connector in your vehicle.
5. Take Connector A on the wiring harness and connect it to the external power connector on your vehicle.
6. Connect the wiring harness connector to the unit.
7. Install the unit in your car.
8. Reconnect the ⊖ terminal of the battery.
9. Press the left part at the upper side of the faceplate once to make the faceplate control panel appear.

▲CAUTION

- If your car is not prepared for this special connection-system, consult your KENWOOD dealer.
- Only use antenna conversion adapters (ISO-JASO) when the antenna cord has an ISO plug.
- Make sure that all cable connections are securely made by inserting jacks until they lock completely.
- If your vehicle's ignition does not have an ACC position, or if the ignition cable is connected to a power source with constant voltage such as a battery cable, the power will not be linked with the ignition (i.e., it will not turn on and off along with the ignition). If you want to link the unit's power with the ignition, connect the ignition cable to a power source that can be turned on and off with the ignition key.
- If the fuse blows, first make sure that the cables have not caused a short circuit, then replace the old fuse with one with the same rating.
- Do not let unconnected cables or terminals touch metal on the car or anything else conducting electricity. To prevent short circuits, also do not remove the caps on the ends of the unconnected cables or the terminals.
- Connect the speaker cables correctly to the terminals to which they correspond. The unit may receive damage or fail to work if you share the ⊖ cables and/or ground them to any metal part in the car.
- After the unit is installed, check whether the brake lamps, indicators, wipers, etc. on the car are working properly.
- Insulate unconnected cables with vinyl tape or other similar material.
- Some disc changers need conversion cables for connection. See the section on "Safety Precautions" for details.
- If the console has a lid, make sure to install the unit so that the faceplate does not hit the lid when closing and opening.
- Mount the unit so that the mounting angle is 30° or less.

Connecting Cables to Terminals

| Connector Function Guide | | |
|---------------------------------|--------------|---------------------------|
| Pin Numbers for ISO Connectors | Cable Colour | Functions |
| External Power Connector | | |
| A-4 | Yellow | Battery |
| A-5 | Blue/White | Power Control |
| A-6 | Orange/White | Dimmer |
| A-7 | Red | Ignition (ACC) |
| A-8 | Black | Earth (Ground) Connection |
| Speaker Connector | | |
| B-1 | Purple | Rear Right (+) |
| B-2 | Purple/Black | Rear Right (-) |
| B-3 | Gray | Front Right (+) |
| B-4 | Gray/Black | Front Right (-) |
| B-5 | White | Front Left (+) |
| B-6 | White/Black | Front Left (-) |
| B-7 | Green | Rear Left (+) |
| B-8 | Green/Black | Rear Left (-) |

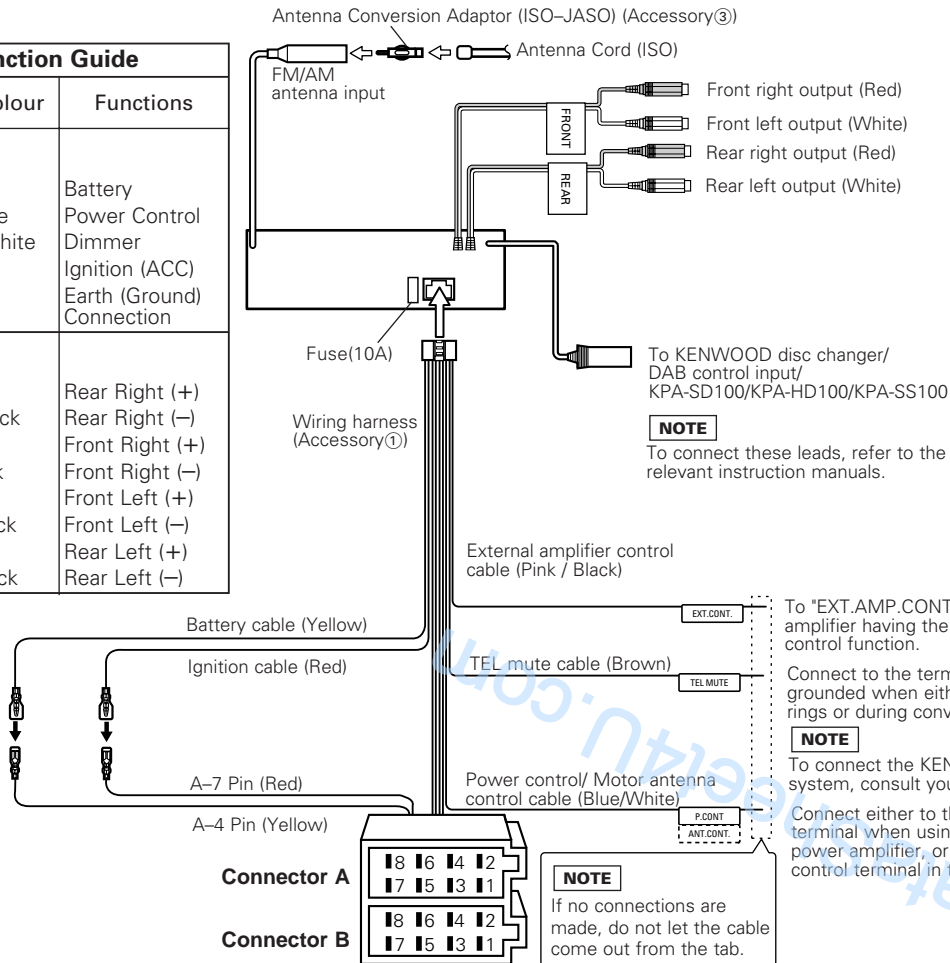

Connecting Cables to Terminals

⚠ WARNING Connecting the ISO Connector (see p.40)

The pin arrangement for the ISO connectors depends on the type of vehicle you drive. Make sure to make the proper connections to prevent damage to the unit.

The default connection for the wiring harness is described in **1** below. If the ISO connector pins are set as described in **2** or **3**, make the connection as illustrated.

- 1** (Default setting) The A-7 pin (red) of the vehicle's ISO connector is linked with the ignition, and the A-4 pin (yellow) is connected to the constant power supply.

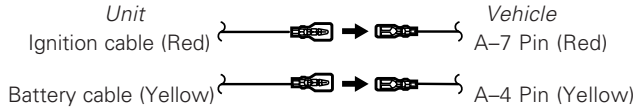

- 2** The A-7 pin (red) of the vehicle's ISO connector is connected to the constant power supply, and the A-4 pin (yellow) is linked to the ignition.

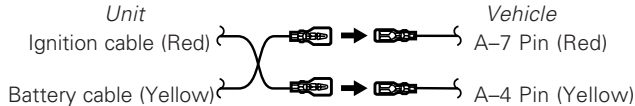

- 3** The A-7 pin (red) of the vehicle's ISO connector is not connected to anything, whilst the A-4 pin (yellow) is connected to the constant power supply (or both the A-7 (red) and A-4 (yellow) pins are connected to the constant power supply).



Installation

■ Installation

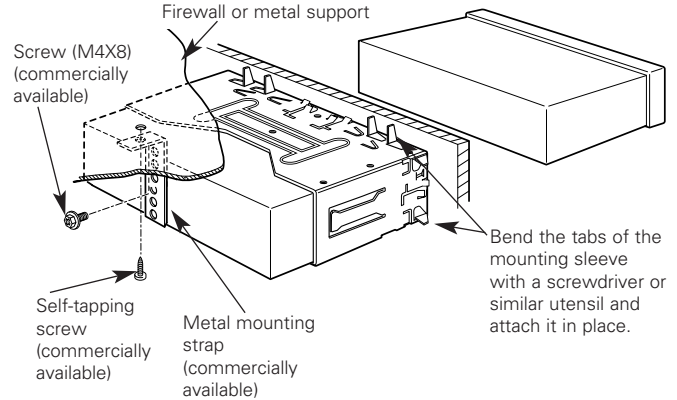

NOTE

Make sure that the unit is installed securely in place. If the unit is unstable, it may malfunction (eg, the sound may skip).

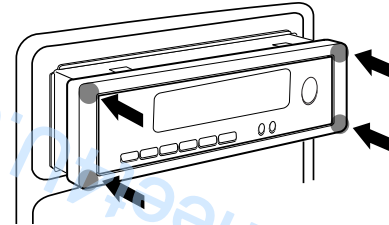

CAUTION

To attach this unit, make sure the front of the control panel faces you and fit it into the mounting sleeve by pressing the four corners of the hard rubber frame at the same time.

Do not apply strong pressure to other sections than the corners; otherwise troubles such as the impossibility of opening or closing the panel may result.

Removing the Unit

■ Removing the hard rubber frame

Insert the removal tool into the indentations in the hard rubber frame, and pull it gently until the lock is released.

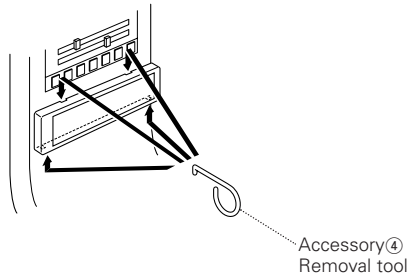

■ Removing the Unit

- 1 Refer to the section “Removing the hard rubber frame” and then remove the hard rubber frame.
- 2 Remove the Hex-head screw with integral washer (M4x8) on the back panel.
- 3 Insert the two removal tools deeply into the slots on each side, as shown.

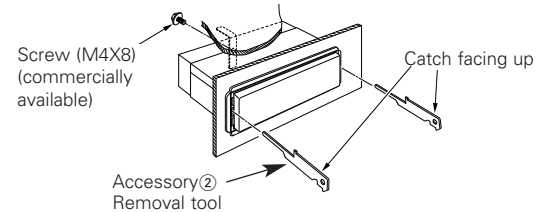

- 4 Push upward the removal tool toward the top, and pull out the unit halfway whilst pressing towards the inside.

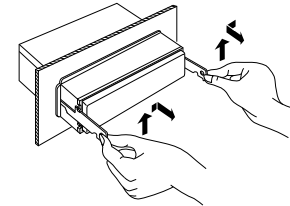

⚠ CAUTION

Be careful to avoid injury from the catch pins on the removal tool.

- 5 Pull the unit all the way out with your hands, being careful not to drop it.

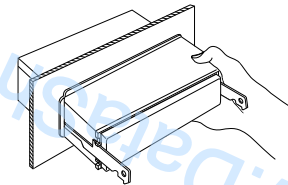

Locking the faceplate to the unit

■ Locking the faceplate to the unit

If you want to lock the faceplate to the unit so that it does not fall off, follow the directions below.

- 1 Refer to the function "Removing the faceplate (page 12)" and remove the faceplate.
- 2 Insert the provided screw into the hole at the centre of the bottom side of the faceplate which you have removed from the unit.

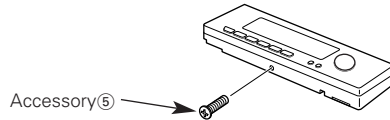

- 3 Refer to the section "Removing the faceplate (page 12)" and then reattaching the faceplate.

▲CAUTION

Never insert the tapite screws ($\varnothing 2 \times 4$ mm) in any other screw holes than the one specified. If you insert it in another hole, it will contract and may cause damage to the mechanical parts inside the unit.

Troubleshooting Guide

What might appear to be a malfunction in your unit may just be the result of slight misoperation or miswiring. Before calling service, first check the following table for possible problems.

| PROBLEM | POSSIBLE CAUSE | SOLUTION |
|---|--|--|
| The power does not turn on. | The fuse has blown. | After checking for short circuits in the cables, replace the fuse with one having the same rating. |
| | No ACC position on vehicle ignition. | Connect the same cable to the ignition as the battery cable. |
| If you have selected Standby mode, the power will go OFF automatically. | The Power Off Timer function has been activated. | If you do not want the power to go OFF automatically, cancel the Power Off Timer function. |
| Nothing happens when the buttons are pressed. | The computer chip in the unit is not functioning normally. | Press the reset button on the unit (see page 4). |
| Radio reception is poor. | The car antenna is not extended. | Pull out the antenna all the way. |
| | The antenna control cable is not connected. | Connect the cable correctly, referring to the section on "Connecting Cables to Terminals". |
| The memory is erased when the ignition is turned off. | The battery cable has not been connected to the proper terminal. | Connect the cable correctly, referring to the section on "Connecting Cables to Terminals". |
| | The ignition and battery cable are incorrectly connected. | Connect the cable correctly, referring to the section on "Connecting Cables to Terminals". |
| The faceplate does not open or close. | The faceplate is incorrectly attached. | Reattach the faceplate correctly, See the section on "Removing the Faceplate".(page.12) |
| The TEL mute function does not work. | The TEL mute cable is not connected properly. | Connect the cable correctly, referring to the section on "Connecting Cables to Terminals". |
| The TEL mute function turns on even though the TEL mute cable is not connected. | The TEL mute cable is touching a metal part of the car. | Pull the TEL mute cable away from the metal part of the car. |
| Free switching of the sound quality. | The system Q function is set on Scan mode. | Refer to the "System Q" page and switch it to a function other than Scan mode. (see p. 10). |
| Audio control setting cannot be achieved. | The system Q function is set on Scan mode. | Refer to the "System Q" page and switch it to a function other than Scan mode.(see p. 10). |

Troubleshooting Guide

| PROBLEM | POSSIBLE CAUSE | SOLUTION |
|--|---|--|
| No sound can be heard, or the volume is low. | The Attenuator function is turned on. | Turn off the Attenuator function. |
| | The fader and/or balance settings are set all the way to one side. | Reset the fader and/or balance settings. |
| | The input/output cables or wiring harness are connected incorrectly. | Reconnect the input/output cables and/or the wiring harness correctly. See the section on "Connecting Cables to Terminals". |
| | The values of Volume offset are low. | Increase the values of Volume offset. (see p. 15) |
| The sound quality is poor or distorted. | A speaker cable may be pinched by a screw in the car. | Check the speaker wiring. |
| | The speakers are not wired correctly. | Reconnect the speaker cables so that each output terminal is connected to a different speaker. |
| A CD ejects as soon as it is loaded. | The CD is upside-down. | Load the CD with the labelled side up. |
| | The CD is quite dirty. | Clean the CD, referring to the section on "Cleaning CDs" (see page 6). |
| The sound skips on a CD. | The CD is scratched or dirty. | Clean the CD, referring to the section on "Cleaning CDs" (see page 6). |
| The specified track does not play. | Random play has been selected. | Turn off the random play function. |
| Can't remove disc. | The cause is that more than 10 minutes has elapsed since the vehicle ACC switch was turned OFF. | The disc can only be removed within 10 minutes of the ACC switch being turned OFF. If more than 10 minutes has elapsed, turn the ACC switch ON again and press the Eject button. |

Troubleshooting Guide

CD/MD/External disc control mode

| PROBLEM | POSSIBLE CAUSE | SOLUTION |
|---|---|---|
| The disc control mode cannot be selected. | No cable has been connected to the disc changer input terminal on the unit. | Connect the cable to the disc changer input terminal on the unit. |
| The specified disc does not play, but another one plays instead. | The specified CD is very dirty. | Clean the CD. |
| | The CD is upside-down. | Load the CD with the labelled side up. |
| | The disc is loaded in a different slot from that specified. | Eject the disc magazine and check the number for the specified disc. |
| The sound skips. | The disc is severely scratched. | Try another disc instead. |
| | Something is touching the disc changer. | Remove whatever is touching it. |
| The display shows that the changer is being played, but no sound can be heard. | The CD is scratched or dirty. | If skipping happens at the same place when the car is stopped, something is wrong with the CD. Clean the CD. |
| | The computer chip in the unit is not functioning normally. | Press the reset button on the unit (see page 4). |
| The specified track does not play. | Random play or magazine random play has been selected. | Turn off the random play or magazine random play function. |
| Track repeat, disc repeat, track scan, random play, and magazine random play start by themselves. | The setting is not cancelled. | The settings for these functions remain on until the setting to off or the disc ejected, even if the power is turned off or the source changed. |
| Cannot play CD-R or CD-RW | Finalization processing is not being conducted for CD-R/CD-RW. | Conduct finalization processing with CD recorder. |
| | A non-compatible CD changer is being used to play the CD-R/CD-RW. | Use a CD changer compatible with CD-R/CD-RW to play. |

If the following situations, consult your nearest service centre:

- Even though the disc changer is connected, the Disc Changer Mode is not on, with "AUX" showing in the display during the Changer Mode.
- Even though no device (KCA-S210A, CA-C1AX, KDC-CPS87, KDC-CX87, KDC-CPS85, KDC-CX85, KDC-CPS82 or KDC-CX82) is connected, the AUX Mode is entered when switching modes.

Troubleshooting Guide

The following messages are displayed when certain problems are occurring in your system. Take the recommended actions.

| | |
|-------------|---|
| Eject | No disc magazine has been loaded in the changer. The disc magazine is not completely loaded. ⇒ Load the disc magazine properly. No CD in the unit. ⇒ Insert the CD. |
| No Disc | No disc has been loaded in the disc magazine. ⇒ Load a disc into the disc magazine. |
| Toc Error | No disc has been loaded in the disc magazine. ⇒ Load a disc into the disc magazine. The CD is very dirty. The CD is upside-down. The CD is scratched a lot. ⇒ Clean the CD and load it correctly. |
| Blank Disc | Nothing has been recorded on the MD. |
| No Tr Disc | No tracks are recorded on the MD, although it has a title. |
| NO PANEL | The faceplate of the slave unit being connected to this unit has been removed. ⇒ Replace it. |
| E-77 | The unit is malfunctioning for some reason. ⇒ Press the reset button on the unit. If the "E- 77", code does not disappear, consult your nearest service centre. |
| Mecha Error | Something is wrong with the disc magazine. Or the unit is malfunctioning for some reason. ⇒ Check the disc magazine. And then, press the reset button on the unit. If the "Mecha Error" code does not disappear, consult your nearest service center. |
| Hold Error | The protective circuit in the unit activates when the temperature inside the automatic disc changer exceeds 60°C (140°F), stopping all operation. ⇒ Cool down the unit by opening the windows or turning on the air conditioner. As the temperature falls below 60°C (140°F), the disc starts playing again. |
| IN | If this indicator blinks, the CD player is malfunctioning. ⇒ Eject the CD and try inserting it again. If the CD cannot be ejected, press the eject button and hold it in until the CD is ejected. |

Specifications

Specifications subject to change without notice.

FM tuner section

| | |
|------------------------------------|-------------------------|
| Frequency range (50 kHz space) | 87.5 MHz – 108.0 MHz |
| Usable sensitivity (S/N = 26dB) | 0.7 μ V/75 Ω |
| Quieting Sensitivity (S/N = 46dB) | 1.6 μ V/75 kHz |
| Frequency response (\pm 3 dB) | 30 Hz – 15 kHz |
| Signal to Noise ratio (MONO) | 65 dB |
| Selectivity (DIN) (\pm 400 kHz) | \geq 80 dB |
| Stereo separation (1 kHz) | 35 dB |

MW tuner section

| | |
|---------------------------------|--------------------|
| Frequency range (9 kHz space) | 531 kHz – 1611 kHz |
| Usable sensitivity (S/N = 20dB) | 25 μ V |

LW tuner section

| | |
|---------------------------------|-------------------|
| Frequency range | 153 kHz – 281 kHz |
| Usable sensitivity (S/N = 20dB) | 45 μ V |

CD player section

| | |
|-----------------------------------|-----------------------------|
| Laser diode | GaAlAs (λ =780 nm) |
| Digital filter (D/A) | 8 Times Over Sampling |
| D/A Converter | 1 Bit |
| Spindle speed | 500 – 200 rpm (CLV) |
| Wow & Flutter | Below Measurable Limit |
| Frequency response (\pm 1 dB) | 10 Hz – 20 kHz |
| Total harmonic distortion (1 kHz) | 0.01 % |
| Signal to Noise ratio (1 kHz) | 105 dB |
| Dynamic range | 93 dB |
| Channel separation | 85 dB |

Audio section

| | |
|--|-----------------------|
| Maximum output power | 47 W \times 4 |
| Output power (DIN 45324, +B=14.4V) | 29 W \times 4 |
| Tone action | |
| Bass : | 100 Hz \pm 10 dB |
| Middle : | 1 kHz \pm 10 dB |
| Treble : | 10 kHz \pm 10 dB |
| Preout level / Load (during disc play) | 1800 mV/10 k Ω |
| Preout impedance (during disc play) | \leq 600 Ω |

General

| | |
|--|-------------------|
| Operating voltage (11 – 16V allowable) | 14.4 V |
| Current consumption | 10 A |
| Installation Size (W x H x D) | 182 x 53 x 162 mm |
| Weight | 1.9 kg |