



# UM5106B

## 6 Sec Voice Synthesizer with Serial/Random Trigger

### Features

- Operating Voltage Range: 2.4V - 5.1V
- Power supply mode selectable by PWD
- 6 second voice duration
- 12 voice sections with serial or random trigger functions
- The STA/STB can option for stop pulse, busy, or LED flash functions
- Built-in OSC circuit with one external resistor
- Built-in piezo buzzer driver
- Built-in audio current D/A converter for speaker
- First key priority
- Power-on trigger
- Automatic power down
- Mask options for:
  - TRIGGER mode
  - STOP mode
  - Retriggerable feature
  - Stop pulse and LED flash
  - Voice data pulse
  - Word combinations
  - Mute intervals
  - CDS trigger function
- Available in 24-pin DIP and in CHIP FORM

### General Description

The UM5106B is a single-chip voice synthesizing CMOS IC that can synthesize voice data up to 6 seconds in duration. The UM5106B contains most of the circuits needed for voice synthesis applications and

can be applied in various voice systems with minimal external parts. Customer voice data and control modes can be programmed by changing a single mask during device fabrication.

### Pin Configuration

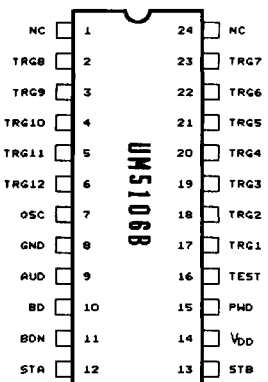

### Pad Configuration

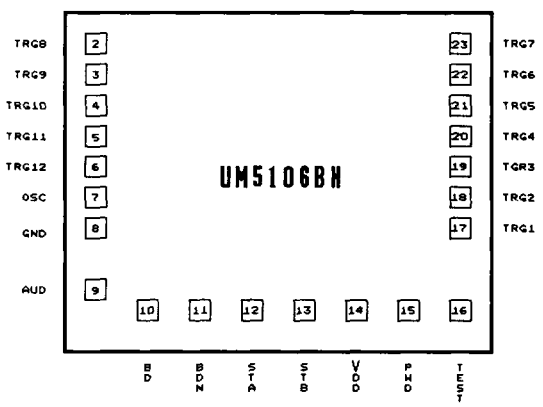

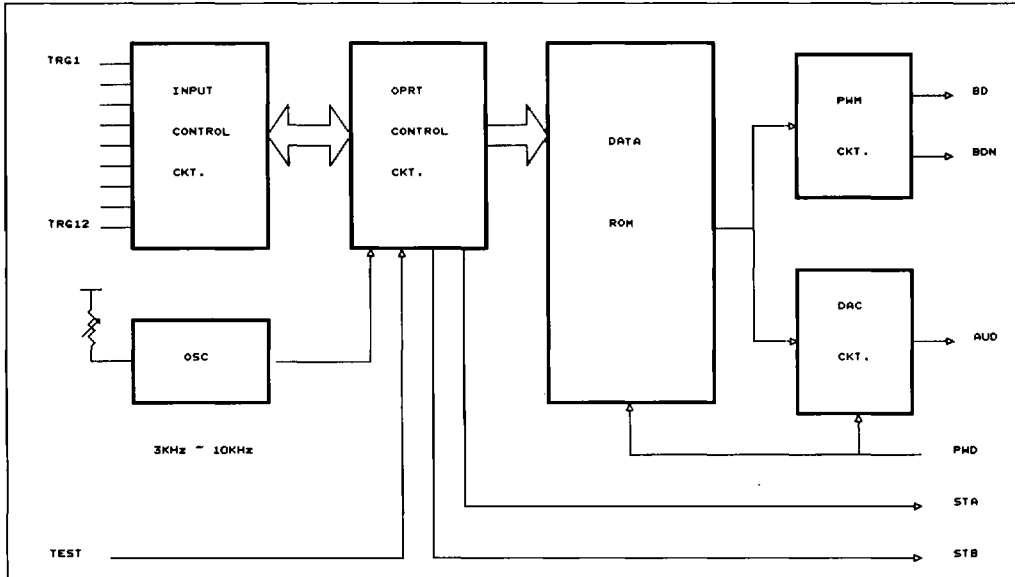
**Block Diagram**

**Absolute Maximum Ratings\***

DC Supply Voltage . . . . . -0.3V to +6V  
 Input Voltage . . . . . GND -0.3V to V<sub>DD</sub> +0.3V  
 Operating Ambient Temperature . . . . -10°C to +60°C  
 Storage Temperature . . . . . -50°C TO +125°C

**\*Comments**

Stresses above those shown under "Absolute Maximum Ratings" may cause permanent damage to the device. These are stress ratings only. Functional operation of this device at these or any other conditions above those indicated in the operational sections of this specification is not implied and exposure to absolute maximum rating conditions for extended periods may affect device reliability.

**DC Electrical Characteristics (Ta = 25°C)**

Parameter	Symbol	Min.	Typ.	Max.	Unit	Conditions
Operating Voltage	V <sub>DD</sub>	2.4	4.5	5.1	V	
Operating Current	I <sub>op</sub>	-	-	2.0	mA	V <sub>DD</sub> = 4.5V
Standby Current	I <sub>sb</sub>	-	0.5	2.0	μA	All I/O pull low
Input Voltage (TRG1— TRG12)	V <sub>ih</sub>	4	4.5	5.0 <sup>1</sup>	V	V <sub>DD</sub> = 4.5V
	V <sub>il</sub>	-0.3	0.0	0.3	V	

**DC Electrical Characteristics (continued)**

Parameter	Symbol	Min.	Typ.	Max.	Unit	Conditions
Input Current (TRG1— TRG12)	Iih	-	20	-	μA	VDD = 4.5V, Vin = 4.5V
	Iil	-	0.0	-	μA	VDD = 4.5V, Vin = 0.0V
Input Current (TRG8) (CDS Function)	Iih	-	-	5	μA	VDD = 4.5V, Vin = 4.5V
	Iil	-	0.0	-	μA	VDD = 4.5V, Vin = 0.0V
PWD Input Current	Iih	-	30	-	μA	PWD = GND During Power-on-reset
AUD Output Current (Half Scale Value)	Ioc1	-2.5	-3.0	-3.5	mA	PWD = NC or VDD VDD = 4.5V, Vout = 0.7V
	Ioc2	-2.0	-2.5	-3.0	mA	PWD = GND VDD = 3.0V, Vout = 0.7V
Output Current (BD & BDN)	Idrive	-	-	-5	mA	VDD = 4.5V, Voh = 4.0V
	Isink	5	-	-	mA	VDD = 4.5V, Vol = 0.5V
Output Current (STA or STB) Stop pulse option	Ioh	-	-	-2	mA	VDD = 4.5V, Vout = 4.0V
	Iol	2	-	-	mA	VDD = 4.5V, Vout = 0.5V
Output Current (STA or STB) LED flash option	Ioh	20	100	-	μA	VDD = 3.0V, Vout = 2.5V
	Iol	-6	-7	-8	mA	VDD = 3.0V, Vout = 1.0V
Frequency Stability	ΔF/F	-	-	5	%	$\frac{F_{osc}(4.5V) - F_{osc}(4.0V)}{F_{osc}(4.5V)}$
Frequency Variation	ΔF/F	-	-	15	%	VDD = 4.5V

**AC Characteristics**

Parameter	Symbol	Min.	Typ.	Max.	Unit	Conditions
Key-in Debounce Time	Tdin	7	8	9	ms	Sampling rate = 6 KHz
Key Release Time	Tdr	27	30	33	ms	Sampling rate = 6 KHz
Stop Pulse Width	Wsp	18	18.6	19	ms	Sampling rate = 6 KHz

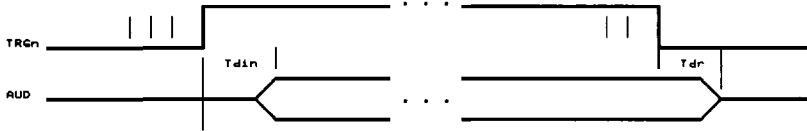
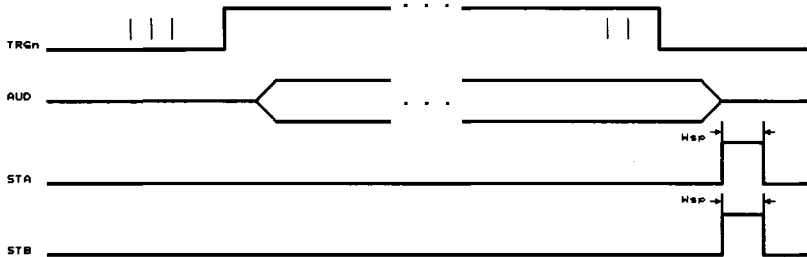
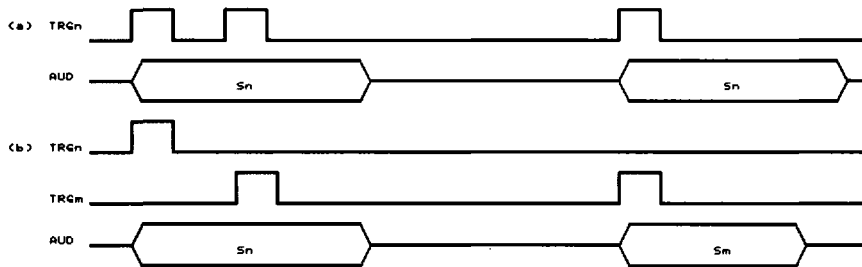
**Timing Waveforms**
**(1) Key-in Debounce**

**(2) STOP Pulse Width**

**(3) EdgeTrigger Mode**
**■ Non-retriggerable**

\* STA(STB) pulse or LED flash frequency or level output selectable by mask option.

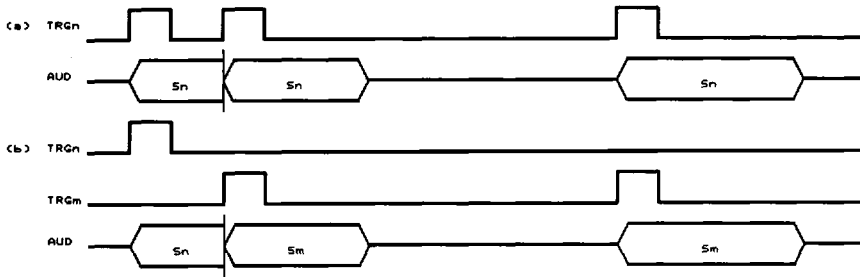
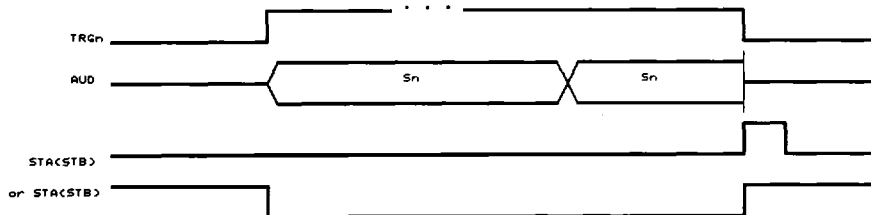
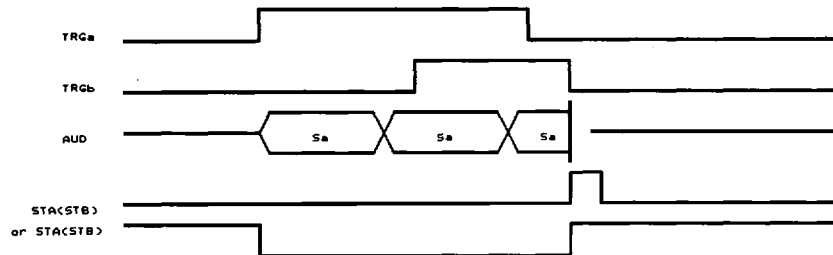
\* n, m : 1 - 12

\* n > m

**Timing Waveforms (continued)**
**■ Retriggerable**

**(4) Level Trigger Mode**
**■ STOP mode: Immediate Stops**
**(a)**

**(b)**

\* STA(STB) pulse or LED flash frequency or level output selectable by mask option.

\* n, m : 1 - 12

\* n > m

\* a, b : 1 - 12

**Timing Waveforms (continued)**
**■ STOP mode: Stops after Last Section Ends**

(c)

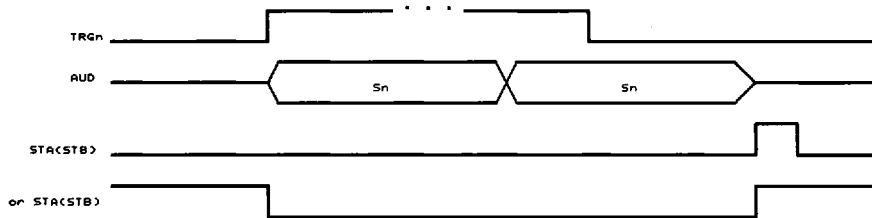

(d)

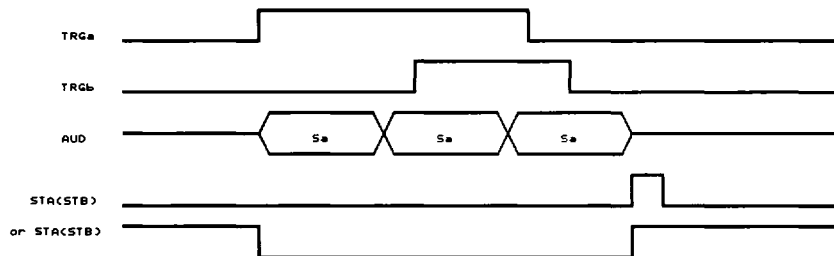
**■ STOP mode: Includes both Immediate Stops and Stops after Last Section Ends**

(e)

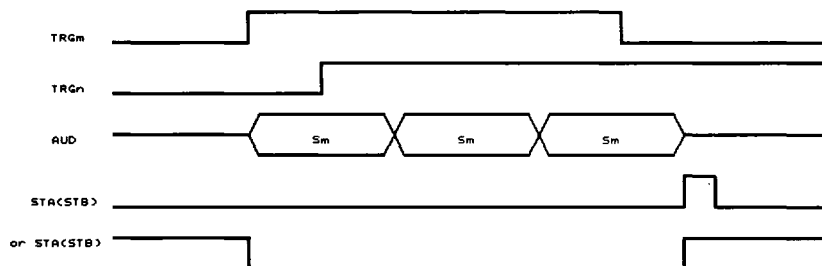

\* STA(STB) pulse or LED flash frequency or level output selectable by mask option.

 \*  $n, m : 1 - 12$ 

 \*  $n > m$ 

 \*  $a, b : 1 - 12$

**Timing Waveforms (continued)**

■ **STOP mode: Includes both Immediate Stops and Stops after Last Section Ends (continued)**

(f)

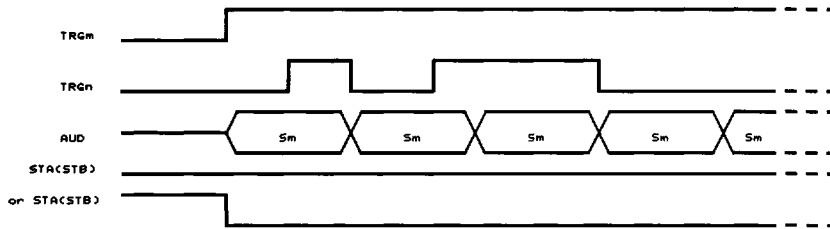

(g)

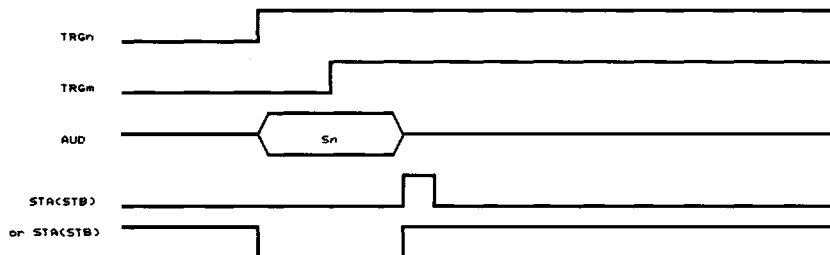

(h)

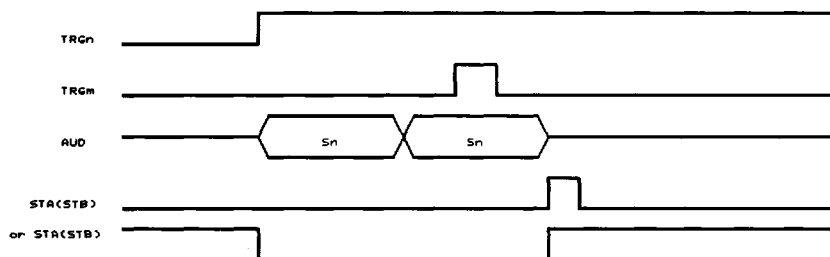

\* STA(STB) pulse or LED flash frequency or level output selectable by mask option.

\* n, m : 1 - 12

\* n > m

\* a, b : 1 - 12

**Pin and Pad Descriptions**

Pin No.	Pad No.	Designation	I/O	Description
2 - 5	2 - 5	TRG8 - TRG11	I	Section trigger pins. (with built-in pull low resistor) TRG8 is CDS trigger (mask option)
17 - 23	17 - 23	TRG1 - TRG7	I	
6	6	TRG12	I	Serial or random trigger for TRG12 (mask option)
7	7	OSC	I	Oscillator frequency adjustable by changing the value of external pull high resistor (oscillator frequency ranges from 384 KHz to 1280 KHz) (sampling rates are from 3 KHz to 10 KHz)
8	8	GND		Ground
9	9	AUD	O	Audio output
10	10	BD	O	Piezo buzzer driver output Remains low when no output
11	11	BDN	O	
12	12	STA	O	Pulse or LED flash frequency or level output by mask option
13	13	STB	O	
14	14	V <sub>DD</sub>		Positive power supply
15	15	PWD	I	Power supply mode control V <sub>DD</sub> = 3V, PWD = GND; V <sub>DD</sub> = 4.5V, PWD = V <sub>DD</sub> or NC
16	16	TEST	I	For testing; normally open
1, 24		NC	-	No connection



## Functional Description

### 1. Sampling Frequency

In different voice applications, the overall sampling frequency of the voice data falls between 3 KHz and 10 KHz.

As the sampling frequency is directly related to the oscillator frequency, the required sampling frequency can be easily obtained by adjusting the oscillator frequency. With the UM5106B, the oscillator frequency can be adjusted simply by changing the external resistor of OSC.

### 2. Debounce Circuit

The UM5106B provides a debounce circuit to prevent unexpected triggers from noise in its environment. The key-in debounce circuit prevents spiking or noise from activating UM5106B. To ensure proper triggering, the positive TRGn signal must be longer than Tdin.

To deactivate the voice section, the negative signal of TRGn must be longer than Tdr. This can prevent incorrect deactivation of the voice section by spiking or noise.

### 3. Stop Pulse Width

In some cascade applications, the stop pulse is used to trigger the slave IC. In this case, the stop pulse width of the master chip must be longer than the key-in debounce time or set-up time of the slave IC. Otherwise, the stop pulse will fail to trigger the slave IC.

### 4. CDS Trigger Function

The UM5106B includes a CDS trigger function by the mask option. This function is assigned to TRG8 only. The CDS trigger has a concern in noise interference. If the customer doesn't need the CDS trigger, use of the KEY trigger type is suggested.

## 5. TRIGGER Mode Options

There are 12 voice sections in the UM5106B. Each section can be made to perform Edge, Level, Serial or Random trigger functions in various applications. Each voice section can be made to perform Edge trigger or Level trigger functions by the mask option. If the TRIGGER mode of a selected section is a Level trigger, an additional option is provided to determine whether to stop immediately or after a delay when the trigger signal goes low.

If the Serial trigger function is selected, TRG1-TRG11 section will still have EDGE or LEVEL mode functions. However, TRG12 will perform Serial trigger function triggering the 1st section to 12th section in sequence. Additionally, if the continuous Serial trigger is interrupted by any one of the triggers TRG1 - TRG11, another option is provided to select whether to re-start the play sequence or continue from where it was interrupted.

If the Random trigger function is selected, TRG1-TRG11 section will still have EDGE or LEVEL mode functions. However TRG12 will perform Random trigger functions. Once TRG12 is triggered, selection of the section to be played (the sequence) will be random.

#### (a) EDGE Mode

When a positive pulse of width greater than the debounce time is forced into the TRGn pin, the trigger section will be activated and will continue until the end of the section, regardless of whether TRGn remains high or not.

#### (b) LEVEL Mode (and STOP Mode Option)

When TRGn is pulled high for a period greater than the debounce time the triggered selection will be activated. As long as TRGn is high, the triggered section will repeat itself.

The end point of a voice section in LEVEL trigger mode can be set by mask option to stop immediately or after a delay. If the STOP mode is stop immediately, the stop pulse will appear immediately after the falling edge of TRGn, with a delay of Tdr (key release debounce). In STOP DELAY mode, the stop pulse will appear only after the triggered section ends.

(c) SERIAL mode (as well as Loop Number, Restart, and Continuous options)

There is a sequence counter to store the sequential number of the SERIAL mode. The counter will be incremented according to the loop number whenever TRG12 is triggered and will return to the 1st section if the sequential number is equal to the loop number.

For example: Loop number = 5

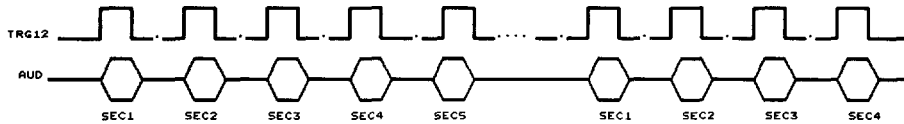

While in RESTART mode, the sequential counter will be cleared to the 1st section at the interruption of any TRGn, except when TRG12 is triggered. This means that the first section will be played when triggering TRG12 continues after the interrupt.

For example: Loop number = 5

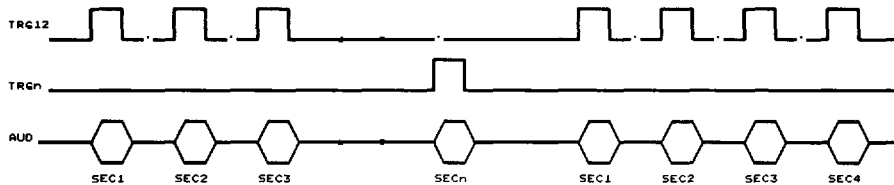

However, while in CONTINUOUS mode, the sequential counter will not be cleared when any TRGn is interrupted. The next section recorded or stored in the counter will be played when triggering TRG12 continues after the interruption.

For example: Loop number = 5

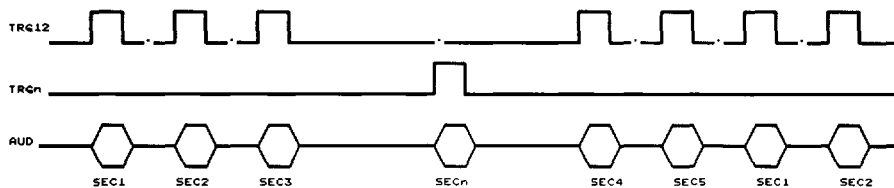

(d) **RANDOM Mode**

In the **RANDOM** mode, the sequence counter changes to a random counter. The counter generates a random number and plays the corresponding section once whenever TRG12 is triggered. The number generated by the counter will be smaller equal to the loop number.

For example, Loop number = 5

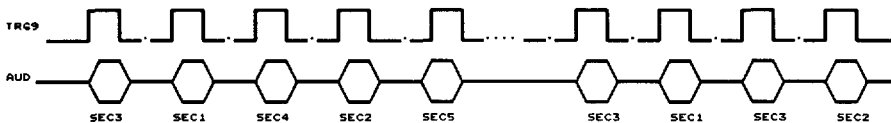

**6. Retrigger Options**

There are two types of Retrigger options: Non-retriggerable and Retriggerable.

(a) **Non-retriggerable**

When a section is still active and a new section is triggered, the new section will be activated only after the previous section ends.

(b) **Retriggerable**

When a section is still active and a new section is triggered, the current section will be aborted and the new section will be activated.

**7. Stop Pin Options (and LED Flash Options)**

There are two stop pins, STA and STB. Each of these pins can be set to perform a stop function or LED flash function. The Stop function can be programmed so that a stop pulse is output from STA or STB at the end of each section. Alternately, the chip can be programmed so that neither STA nor STB outputs a stop signal at the end of a section.

■ **Stop Pin Options:**

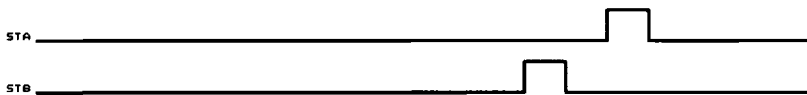

■ **LED Flash Options:**

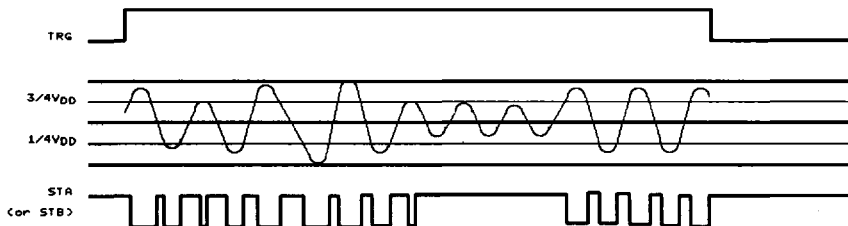

The LED flash function can be used to make STA or STB output a waveform of 0, 3, 6 Hz or corresponding to the analog waveform of the audio output. The LED will thus flash once for each word. There are 4 options for the flash selection of STA or STB pin.

For the STB pin:

The first option is 0 level. When this option is selected, the pin will always be active low, similar to a busy signal.

The second option is 3 Hz flash.

The third option is 6 Hz flash.

The last option is corresponding to the analog waveform level. This option makes STB active low when the level of the analog waveform is higher than  $3/4 V_{DD}$  or lower than  $1/4 V_{DD}$ .

For the STA pin:

The first option is 0 level. When this option is selected, the pin will always be active low, similar to a busy signal.

The second option 3 Hz flash.

The third option is 6 Hz flash.

The last option is corresponding to the analog waveform level. This option makes STA active low when the level of the analog waveform is higher than  $3/4 V_{DD}$  or lower than  $1/4 V_{DD}$ .

When STA and STB are option to the same flash frequency (3 or 6 Hz), they will flash alternatively.

## 8. Word Combinations

The UM5106B has 12 trigger sections, each of which can include words and mute intervals. Each section can contain up to 64 words. Altogether, the 12 sections can contain a total of 128 words.

### (a) Words

The UM5106B has a built-in ROM to accommodate all the voice data. The voice data is pre-sampled by a UMC tooling system, and the words are named. The duration of each word can range from 0 sec to 6 sec. However, the total duration of all of the words cannot exceed 6 sec (at 6K sampling rate).

For example, the data ROM might have 10 voice data (words) totaling 6 sec,

word 1,	'I',	0.4 sec;
word 2,	'LOVE',	0.6 sec;
word 3,	'DOGS',	0.5 sec;
word 4,	'CATS',	0.5 sec;
word 5,	'BIRDS',	0.5 sec;
word 6,	'COWS',	0.5 sec;
word 7,	'TIGERS',	0.8 sec;
word 8,	'EAGLES',	0.8 sec;
word 9,	'AND',	0.9 sec;
word 10,	'ELEPHANTS',	0.5 sec.

### (b) Mute Interval

Typically, between the words in a section there is a brief period in which the signal level is almost silent. This period can be replaced by a mute interval to save the data ROM capacity, (which is 10 seconds in this chip).

The UM5106B offers a mute interval which is provided by a programming counter. Users just need to add a mute interval at the end of each word and the UM5106B will arrange the programming counter automatically. The duration of the mute interval may range from 0 - 10 seconds.

(c) Sections

Each section can have a different combination (play sequence) of words. The total number of words that can be stored in the 12 sections is 128, and the maximum number of words in a single section is 64.

For example, any of the 16 words listed in section (a) can be used to construct the 12 sections. The following combinations, for instance, use a total of 71 words. Mute intervals have been inserted after each word.

```

section 1: 'I'      'LOVE'  'DOGS'.
           w1  m1  w2   m2  w3   m3

section 2: 'I'      'LOVE'  'CATS' .
           w1  m1  w2   m2  w4   m3

section 3: 'I'      'LOVE'  'BIRDS' .
           w1  m1  w2   m2  w5   m3

section 4: 'I'      'LOVE'  'COWS':
           w1  m1  w2   m2  w6   m3

section 5: 'I'      'LOVE'  'TIGERS' .
           w1  m1  w2   m2  w7   m3

section 6: 'I'      'LOVE'  'EAGLES'.
           w1  m1  w2   m2  w8   m3

section 7: 'I'      'LOVE'  'ELEPHANTS'.
           w1  m1  w2   m2  w10  m3

section 8: 'I'      'LOVE'  'DOGS',
           w1  m1  w2   m2  w3   m3

           'CATS', 'BIRDS', 'COWS', 'AND',
           w4  m4  w5   m5  w6   m6  w9  m7

           'ELEPHANTS'.
           w10      m8
    
```

```

section 9: 'I'      'LOVE'  'DOGS' .
           'I'      'LOVE'  'CATS' .
           'I'      'LOVE'  'BIRDS'.
           'I'      'LOVE'  'COWS'.
           'I'      'LOVE'  'TIGERS' .
           'I'      'LOVE'  'EAGLES'.
           'I'      'LOVE'  'ELEPHANTS'.
           'I'      'LOVE'  'DOGS', 'CATS',
           'BIRDS', 'COWS', 'TIGERS', 'EAGLES',
           'AND', 'ELEPHANTS'.
    
```

```

section 10: 'I'      'LOVE'  'BIRDS' 'AND'
            w1  m1  w2   m2   w5   m3  w9   m4

            'COWS':
            w6   m5
    
```

```

section 11: 'I'      'LOVE'  'CATS' .
            w1  m1  w2   m2   w4   m3
    
```

```

section 12: 'I'      'LOVE'  'ELEPHANTS':
            w1  m1  w2   m2   w10  m3
    
```

**9. POWER SUPPLY Mode**

For 4.5V application PWD should be equal to V<sub>DD</sub> or NC, the UM5106B clamps the supply voltage of some internal circuits to reduce power consumption. If the environment is very noisy, PWD should definitely be set to V<sub>DD</sub>.

Let PWD = GND, if it is a 3.0V application. For 3.0V applications, PWD should equal GND. Otherwise, the supply voltage to some internal circuits will be clamped from 3.0V to a voltage that will cause the UM5106B to work improperly. In addition, the UM5106B includes a circuit for 3.0V applications that maintains the AUD output current at almost the same level as in 4.5V applications. This optional circuit can alleviate output current reduction caused by low supply voltage.

**Application Circuits** (for reference only)

**(1) Power Supply 4.5 Volt Applications**

(a) Speaker Output

(b) Buzzer Output

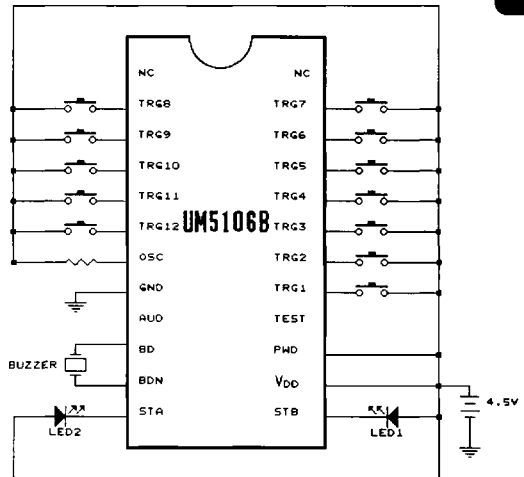
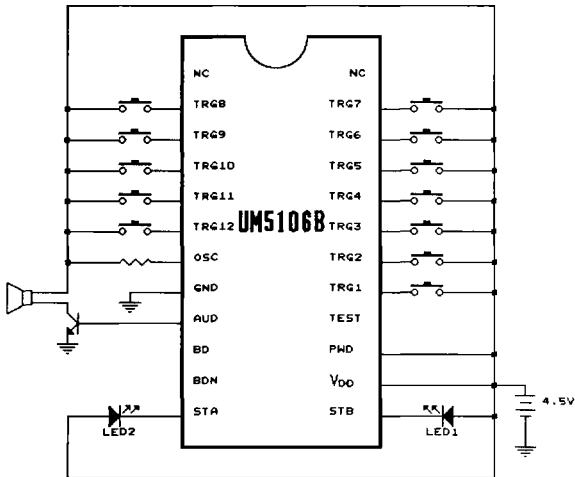
**(2) Power Supply 3.0 Volt Applications**

(a) Speaker Output

(b) Buzzer Output

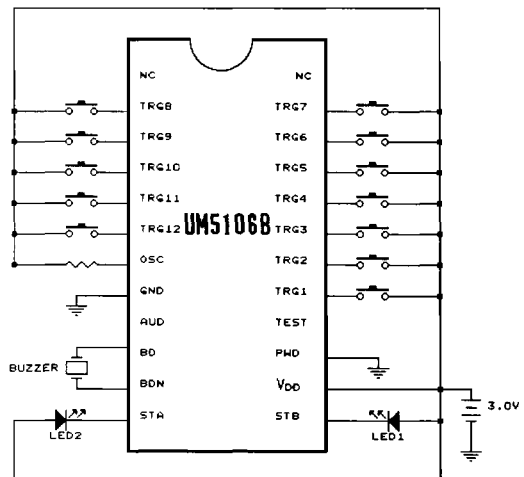
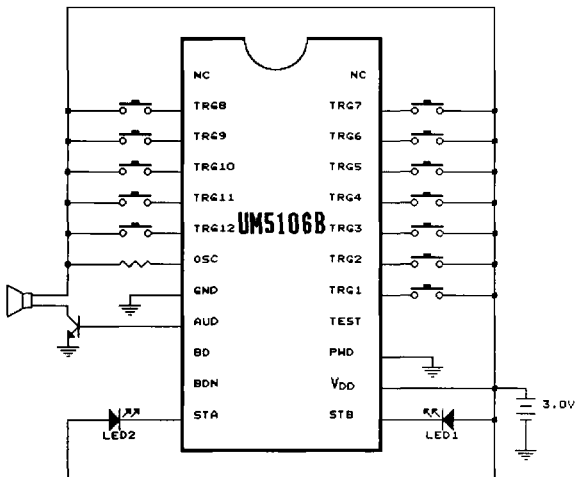

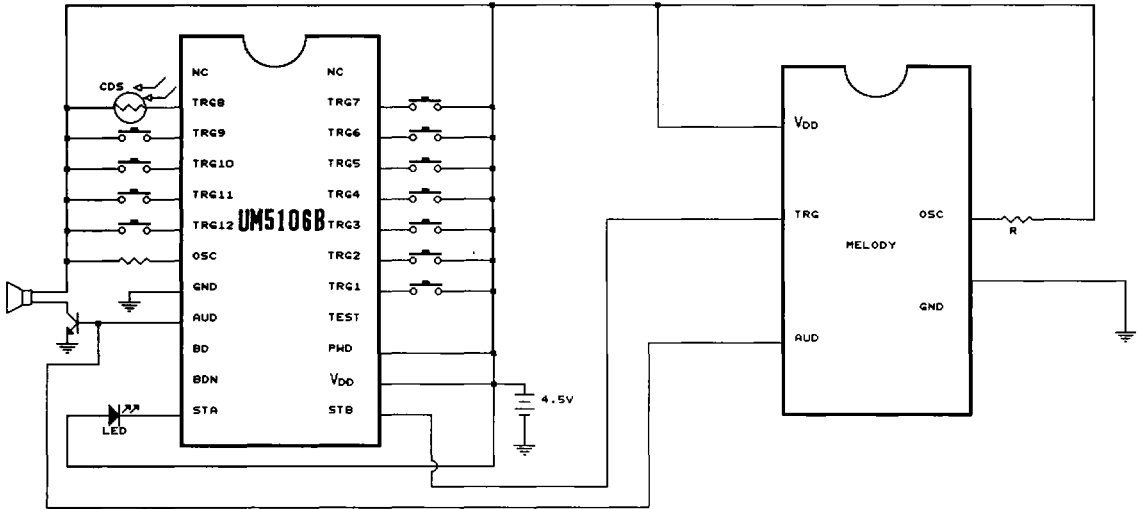
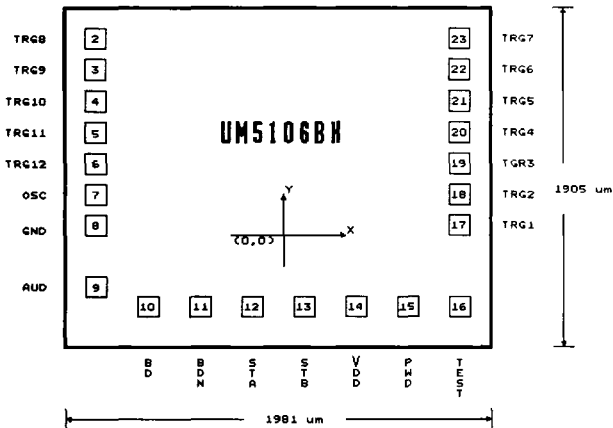
**Application Circuits (continued)**
**(3) Voice With Melody Applications**

**Bonding Diagram**

\* Substrate connect to GND.

(unit:  $\mu\text{m}$ )

Pad No.	Designation	X	Y
2	TRG8	-847.0	754.1
3	TRG9	-847.0	591.3
4	TRG10	-847.0	390.1
5	TRG11	-847.0	227.3
6	TRG12	-847.0	26.1
7	OSC	-847.0	-136.7
8	GND	-847.0	-310.0
9	AUD	-827.9	-732.0
10	BD	-528.4	-795.6
11	BDN	296.9	-795.6
12	STA	51.7	-795.6
13	STB	179.8	-795.6
14	VDD	388.0	-809.0
15	PWD	539.1	-812.6
16	TEST	757.3	-806.0
17	TRG1	841.2	-334.7
18	TRG2	841.2	-133.5
19	TRG3	841.2	29.3
20	TRG4	841.2	230.5
21	TRG5	841.2	393.3
22	TRG6	841.2	594.5
23	TRG7	841.2	757.3

---

**Ordering Information**

<b>Part No.</b>	<b>Application</b>	<b>Package</b>
UM5106BH — XX01	KEY trigger	CHIP FORM
UM5106BH — XX02	CDS trigger (TRG8)	CHIP FORM
UM5106B — XX01	KEY trigger	24L DIP
UM5106B — XX02	CDS trigger (TRG8)	24L DIP

XX : Code numbering assigned per customer specifications

X : 0 - 9, A - Z