



CY7C024/0241
CY7C025/0251

4K x 16/18 and 8K x 16/18 Dual-Port Static RAM with Sem, Int, Busy

Features

- True Dual-Ported memory cells which allow simultaneous reads of the same memory location
- 4K x 16 organization (CY7C024)
- 4K x 18 organization (CY7C0241)
- 8K x 16 organization (CY7C025)
- 8K x 18 organization (CY7C0251)
- 0.65-micron CMOS for optimum speed/power
- High-speed access: 15ns
- Low operating power: $I_{CC} = 150 \text{ mA}$ (typ.)
- Fully asynchronous operation
- Automatic power-down
- Expandable data bus to 32/36 bits or more using Master/Slave chip select when using more than one device
- On-chip arbitration logic
- Semaphores included to permit software handshaking between ports
- INT flag for port-to-port communication
- Separate upper-byte and lower-byte control
- Pin select for Master or Slave
- Available in 84-pin PLCC and 100-pin TQFP
- Pin-compatible and functionally equivalent to IDT7024/IDT7025

Functional Description

The CY7C024/0241 and CY7C025/0251 are low-power CMOS 4K x 16/18 and 8K x 16/18 dual-port static RAMs. Various arbitration schemes are included on the CY7C024/0241 and CY7C025/0251 to handle situations when multiple processors access the same piece of data. Two ports are provided permitting independent, asynchronous access for reads and writes to any location in memory. The CY7C024/0241 and CY7C025/0251 can be utilized as standalone 16-/18-bit dual-port static RAMs or multiple devices can be combined in order to function as a 32-/36-bit or wider master/slave dual-port static RAM. An M/S pin is provided for implementing 32-/36-bit or wider memory applications without the need for separate master and slave devices or additional discrete logic. Application areas include interprocessor/multiprocessor designs, communications status buffering, and dual-port video/graphics memory.

Each port has independent control pins: chip enable (CE), read or write enable (R/W), and output enable (OE). Two flags are provided on each port (BUSY and INT). BUSY signals that the port is trying to access the same location currently being accessed by the other port. The interrupt flag (INT) permits communication between ports or systems by means of a mail box. The semaphores are used to pass a flag, or token, from one port to the other to indicate that a shared resource is in use. The semaphore logic is comprised of eight shared latches. Only one side can control the latch (semaphore) at any time. Control of a semaphore indicates that a shared resource is in use. An automatic power-down feature is controlled independently on each port by a chip select (CE) pin.

The CY7C024/0241 and CY7C025/0251 are available in 84-pin PLCCs (CY7C024 and CY7C025 only) and 100-pin Thin Quad Plastic Flatpack (TQFP).

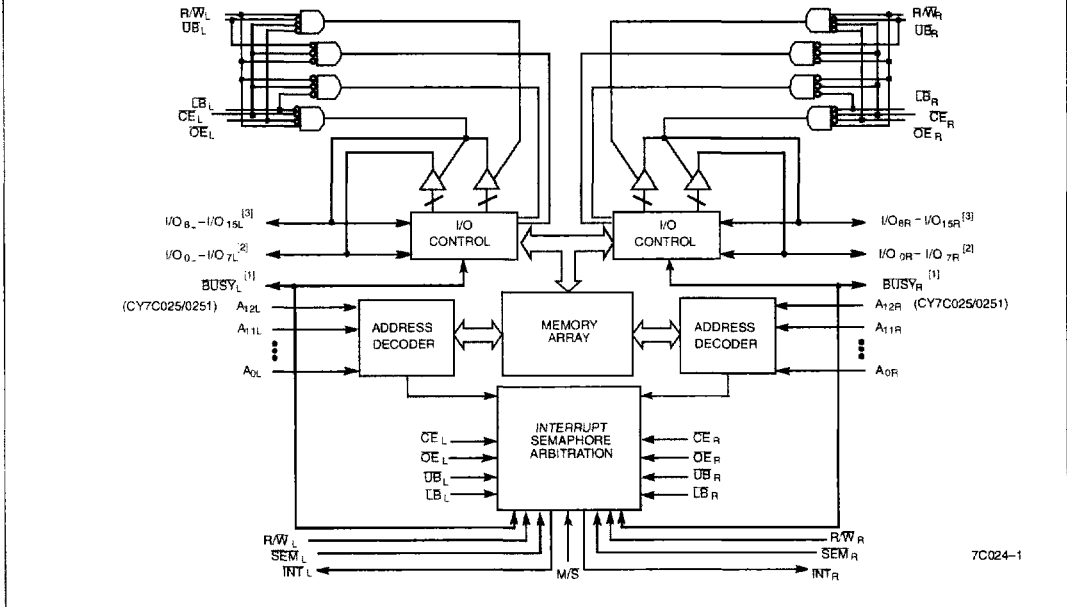
Logic Block Diagram

Notes:

1. **BUSY** is an output in master mode and an input in slave mode.
2. $I/O_0 - I/O_8$ on the CY7C0241/0251.
3. $I/O_9 - I/O_{17}$ on the CY7C0241/0251.

3



Pin Configurations

84-Pin PLCC
Top View

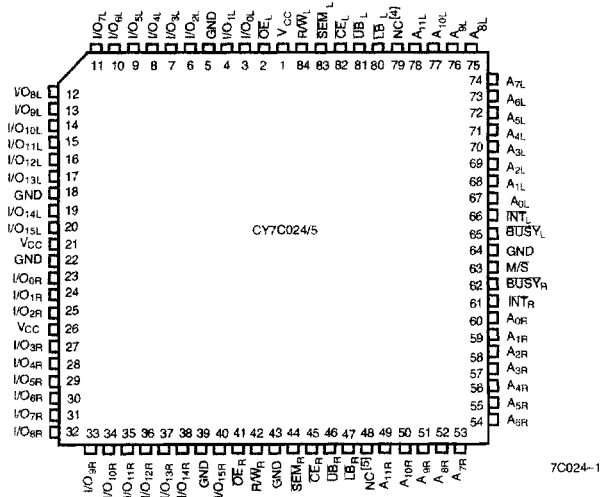

7C024-1

100-Pin TQFP
Top View

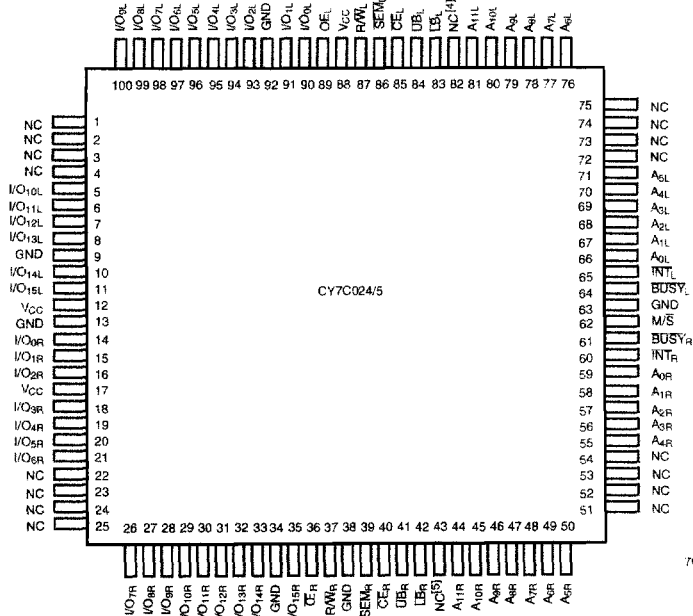

7C024-2

Notes:

4. A_{12L} on the CY7C025/0251.
5. A_{12R} on the CY7C025/0251.



Pin Configurations (continued)

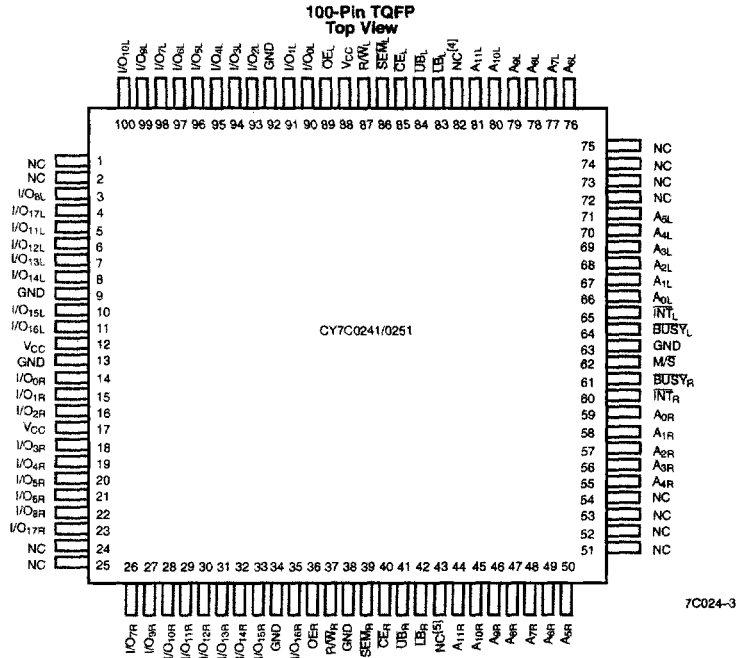

Pin Definitions

Left Port	Right Port	Description
CE _L	CE _R	Chip Enable
R/W _L	R/W _R	Read/Write Enable
OE _L	OE _R	Output Enable
A _{0L} -A _{11/12L}	A _{0R} -A _{11/12R}	Address
I/O _{0L} -I/O _{15/17L}	I/O _{0R} -I/O _{15/17R}	Data Bus Input/Output
SEM _L	SEM _R	Semaphore Enable
UB _L	UB _R	Upper Byte Select
LB _L	LB _R	Lower Byte Select
INT _L	INT _R	Interrupt Flag
BUSY _L	BUSY _R	Busy Flag
M/S		Master or Slave Select
V _{CC}		Power
GND		Ground



Selection Guide

	7C024/0241-15 7C025/0251-15	7C024/0241-25 7C025/0251-25	7C024/0241-35 7C025/0251-35	7C024/0241-55 7C025/0251-55
Maximum Access Time (ns)	15	25	35	55
Typical Operating Current (mA)	190	170	160	150
Typical Standby Current for I _{SB1} (mA)	50	40	30	20

Maximum Ratings

(Above which the useful life may be impaired. For user guidelines, not tested.)

- Storage Temperature -65°C to + 150°C
- Ambient Temperature with Power Applied -55°C to + 125°C
- Supply Voltage to Ground Potential -0.3V to + 7.0V
- DC Voltage Applied to Outputs in High Z State -0.5V to + 7.0V
- DC Input Voltage^[6] -0.5V to + 7.0V

- Output Current into Outputs (LOW) 20 mA
- Static Discharge Voltage >2001V (per MIL-STD-883, Method 3015)
- Latch-Up Current >200 mA

Operating Range

Range	Ambient Temperature	V _{CC}
Commercial	0°C to +70°C	5V ± 10%
Industrial	-40°C to +85°C	5V ± 10%

Electrical Characteristics Over the Operating Range

Parameter	Description	Test Conditions	7C024/0241-15 7C025/0251-15			7C024/0241-25 7C025/0251-25			Unit
			Min.	Typ.	Max.	Min.	Typ.	Max.	
V _{OH}	Output HIGH Voltage	V _{CC} = Min., I _{OH} = -4.0 mA	2.4			2.4			V
V _{OL}	Output LOW Voltage	V _{CC} = Min., I _{OL} = 4.0 mA			0.4			0.4	V
V _{IH}	Input HIGH Voltage		2.2			2.2			V
V _{IL}	Input LOW Voltage		-0.7		0.8	-0.7		0.8	V
I _{IX}	Input Leakage Current	GND ≤ V _I ≤ V _{CC}	-10		+10	-10		+10	μA
I _{OZ}	Output Leakage Current	Output Disabled, GND ≤ V _O ≤ V _{CC}	-10		+10	-10		+10	μA
I _{CC}	Operating Current	V _{CC} = Max., I _{OUT} = 0 mA, Outputs Disabled	Com'l	190	300	170	250	mA	
			Ind			170	290		
I _{SB1}	Standby Current (Both Ports TTL Levels)	CE _L and CE _R ≥ V _{IH} , f = f _{MAX} ^[7]	Com'l	50	70	40	60	mA	
			Ind				75		
I _{SB2}	Standby Current (One Port TTL Level)	CE _L or CE _R ≥ V _{IH} , f = f _{MAX} ^[7]	Com'l	120	180	100	150	mA	
			Ind			100	170		
I _{SB3}	Standby Current (Both Ports CMOS Levels)	Both Ports CE and CE _R ≥ V _{CC} - 0.2V, V _{IN} ≥ V _{CC} - 0.2V or V _{IN} ≤ 0.2V, f = 0 ^[7]	Com'l	3	15	3	15	mA	
			Ind			3	15		
I _{SB4}	Standby Current (Both Ports CMOS Levels)	One Port CE _L or CE _R ≥ V _{CC} - 0.2V, V _{IN} ≥ V _{CC} - 0.2V or V _{IN} ≤ 0.2V, Active Port Outputs, f = f _{MAX} ^[7]	Com'l	110	160	90	130	mA	
			Ind			90	150		

Notes:

- 6. Pulse width < 20 ns.
- 7. f_{MAX} = 1/f_{PC} = All inputs cycling at f = 1/f_{PC} (except output enable). f = 0 means no address or control lines change. This applies only to inputs at CMOS level standby I_{SB3}.



Electrical Characteristics Over the Operating Range (continued)

Parameter	Description	Test Conditions	7C024/0241-35 7C025/0251-35			7C024/0241-55 7C025/0251-55			Unit
			Min.	Typ.	Max.	Min.	Typ.	Max.	
V _{OH}	Output HIGH Voltage	V _{CC} = Min., I _{OH} = -4.0 mA	2.4			2.4			V
V _{OL}	Output LOW Voltage	V _{CC} = Min., I _{OL} = 4.0 mA			0.4			0.4	V
V _{IH}	Input HIGH Voltage		2.2			2.2			V
V _{IL}	Input LOW Voltage		-0.7		0.8	-0.7		0.8	V
I _{IX}	Input Leakage Current	GND ≤ V _I ≤ V _{CC}	-10		+10	-10		+10	μA
I _{OZ}	Output Leakage Current	Output Disabled, GND ≤ V _O ≤ V _{CC}	-10		+10	-10		+10	μA
I _{CC}	Operating Current	V _{CC} = Max., I _{OUT} = 0 mA, Outputs Disabled	Com'l	160	230	150	230	mA	
			Ind	160	260	150	260		
I _{SB1}	Standby Current (Both Ports TTL Levels)	CE _L and CE _R ≥ V _{IH} , f = f _{MAX} ^[7]	Com'l	30	50	20	50	mA	
			Ind	30	65	20	65		
I _{SB2}	Standby Current (One Port TTL Level)	CE _L or CE _R ≥ V _{IH} , f = f _{MAX} ^[7]	Com'l	85	135	75	135	mA	
			Ind	85	150	75	150		
I _{SB3}	Standby Current (Both Ports CMOS Levels)	Both Ports CE and CE _R ≥ V _{CC} - 0.2V, V _{IN} ≥ V _{CC} - 0.2V or V _{IN} ≤ 0.2V, f = 0 ^[7]	Com'l	3	15	3	15	mA	
			Ind	3	15	3	15		
I _{SB4}	Standby Current (Both Ports CMOS Levels)	One Port CE _L or CE _R ≥ V _{CC} - 0.2V, V _{IN} ≥ V _{CC} - 0.2V or V _{IN} ≤ 0.2V, Active Port Outputs, f = f _{MAX} ^[7]	Com'l	80	120	70	120	mA	
			Ind	80	135	70	135		

3

Capacitance^[8]

Parameter	Description	Test Conditions	Max.	Unit
C _{IN}	Input Capacitance	T _A = 25°C, f = 1 MHz, V _{CC} = 5.0V	10	pF
C _{OUT}	Output Capacitance		10	pF

AC Test Loads and Waveforms

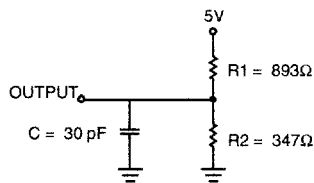

(a) Normal Load (Load 1)

7C024-8

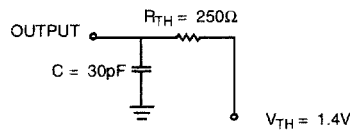

(b) Thévenin Equivalent (Load 1)

7C024-9

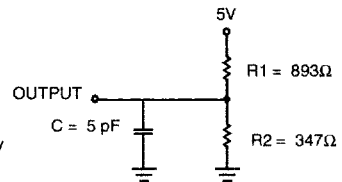

(c) Three-State Delay (Load 3)

7C024-10

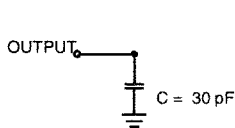

Load (Load 2)

7C024-11

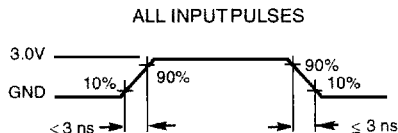

7C024-12

Note:

B. Tested initially and after any design or process changes that may affect these parameters.



Switching Characteristics Over the Operating Range^[9]

Parameter	Description	7C024/0241-15 7C025/0251-15		7C024/0241-25 7C025/0251-25		7C024/0241-35 7C025/0251-35		7C024/0241-55 7C025/0251-55		Unit
		Min.	Max.	Min.	Max.	Min.	Max.	Min.	Max.	
READ CYCLE										
t_{RC}	Read Cycle Time	15		25		35		55		ns
t_{AA}	Address to Data Valid		15		25		35		55	ns
t_{OHA}	Output Hold From Address Change	3		3		3		3		ns
$t_{ACE}^{[10]}$	CE LOW to Data Valid		15		25		35		55	ns
t_{DOE}	OE LOW to Data Valid		10		13		20		25	ns
$t_{LZOE}^{[11,12,13]}$	OE Low to Low Z	3		3		3		3		ns
$t_{HZOE}^{[11,12,13]}$	OE HIGH to High Z		10		15		20		25	ns
$t_{LZCE}^{[11,12,13]}$	CE LOW to Low Z	3		3		3		3		ns
$t_{HZCE}^{[11,12,13]}$	CE HIGH to High Z		10		15		20		25	ns
$t_{PU}^{[13]}$	CE LOW to Power-Up	0		0		0		0		ns
$t_{PD}^{[13]}$	CE HIGH to Power-Down		15		25		25		55	ns
$t_{ABE}^{[10]}$	Byte Enable Access Time		15		25		35		55	ns
WRITE CYCLE										
t_{WC}	Write Cycle Time	15		25		35		55		ns
$t_{SCE}^{[10]}$	CE LOW to Write End	12		20		30		35		ns
t_{AW}	Address Set-Up to Write End	12		20		30		35		ns
t_{HA}	Address Hold From Write End	0		0		0		0		ns
$t_{SA}^{[10]}$	Address Set-Up to Write Start	0		0		0		0		ns
t_{PWE}	Write Pulse Width	12		20		25		35		ns
t_{SD}	Data Set-Up to Write End	10		15		15		20		ns
t_{HD}	Data Hold From Write End	0		0		0		0		ns
$t_{HZWE}^{[12,13]}$	R/W LOW to High Z		10		15		20		25	ns
$t_{LZWE}^{[12,13]}$	R/W HIGH to Low Z	0		0		0		0		ns
$t_{WDD}^{[14]}$	Write Pulse to Data Delay		30		50		60		70	ns
$t_{DDD}^{[14]}$	Write Data Valid to Read Data Valid		25		35		35		45	ns

Notes:

9. Test conditions assume signal transition time of 3 ns or less, timing reference levels of 1.5V, input pulse levels of 0 to 3.0V, and output loading of the specified I_{OL}/I_{OH} and 30-pF load capacitance.
10. To access RAM, CE=L, UB=L, SEM=H. To access semaphore, CE=H and SEM=L. Either condition must be valid for the entire t_{SCE} time.
11. At any given temperature and voltage condition for any given device, t_{HZCE} is less than t_{LZCE} and t_{HZOE} is less than t_{LZOE} .
12. Test conditions used are Load 3.
13. This parameter is guaranteed but not tested.
14. For information on port-to-port delay through RAM cells from writing port to reading port, refer to Read Timing with Busy waveform.



Switching Characteristics Over the Operating Range^[9] (continued)

Parameter	Description	7C024/0241-15 7C025/0251-15		7C024/0241-25 7C025/0251-25		7C024/0241-35 7C025/0251-35		7C024/0241-55 7C025/0251-55		Unit
		Min.	Max.	Min.	Max.	Min.	Max.	Min.	Max.	
BUSY TIMING^[15]										
t _{B_{LA}}	BUSY LOW from Address Match		15		20		20		45	ns
t _{B_{HA}}	BUSY HIGH from Address Mismatch		15		20		20		40	ns
t _{B_{LC}}	BUSY LOW from \overline{CE} LOW		15		20		20		40	ns
t _{B_{HC}}	BUSY HIGH from \overline{CE} HIGH		15		20		20		35	ns
t _{PS}	Port Set-Up for Priority	5		5		5		5		ns
t _{WB}	R/W HIGH after BUSY (Slave)	0		0		0		0		ns
t _{WH}	R/W HIGH after BUSY HIGH (Slave)	13		20		30		40		ns
t _{BDD^[16]}	BUSY HIGH to Data Valid		Note 16		Note 16		Note 16		Note 16	ns
INTERRUPT TIMING^[15]										
t _{INS}	INT Set Time		15		20		25		30	ns
t _{INR}	INT Reset Time		15		20		25		30	ns
SEMAPHORE TIMING										
t _{SOP}	SEM Flag Update Pulse (\overline{OE} or SEM)	10		12		15		20		ns
t _{SWRD}	SEM Flag Write to Read Time	5		10		10		15		ns
t _{SPS}	SEM Flag Contention Window	5		10		10		15		ns
t _{SAA}	SEM Address Access Time		15		25		35		55	ns

Notes:

- 15. Test conditions used are Load 2.
- 16. t_{BDD} is a calculated parameter and is the greater of t_{WDD}-t_{PWE} (actual) or t_{BDD}-t_{SD} (actual).

Data Retention Mode

The CY7C024/0241 is designed with battery backup in mind. Data retention voltage and supply current are guaranteed over temperature. The following rules insure data retention:

1. Chip enable (\overline{CE}) must be held HIGH during data retention, within V_{CC} to V_{CC} - 0.2V.
2. \overline{CE} must be kept between V_{CC} - 0.2V and 70% of V_{CC} during the power-up and power-down transitions.
3. The RAM can begin operation >t_{RC} after V_{CC} reaches the minimum operating voltage (4.5 volts).

Timing

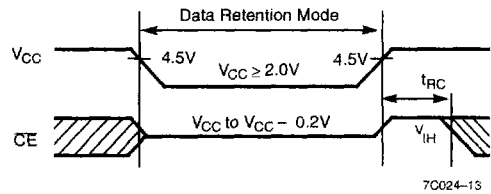

Parameter	Test Conditions ^[17]	Max.	Unit
ICC _{DR1}	@ V _{CCDR} = 2V	1.5	mA

Note:

- 17. $\overline{CE} = V_{CC}$, V_{in} = GND to V_{CC}, T_A = 25°C. This parameter is guaranteed but not tested.

Switching Waveforms

Read Cycle No.1 (Either Port Address Access)^[18,19,20]

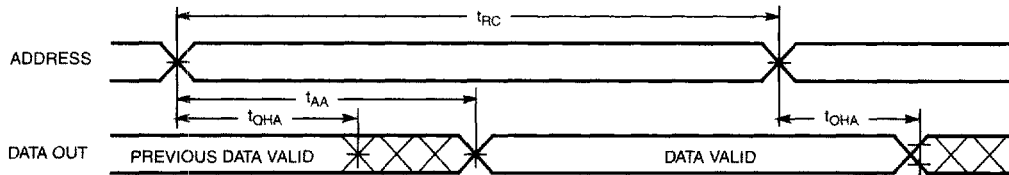

7C024-14

Read Cycle No.2 (Either Port $\overline{CE}/\overline{OE}$ Access)^[18,21,22]

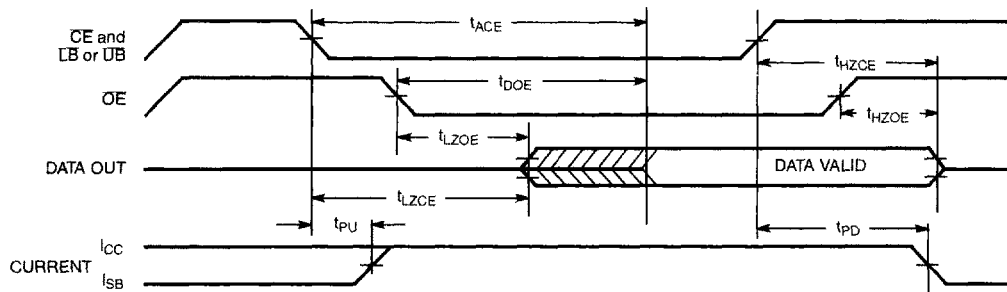

7C024-15

Read Cycle No.3 (Either Port)^[18,20,21,22]

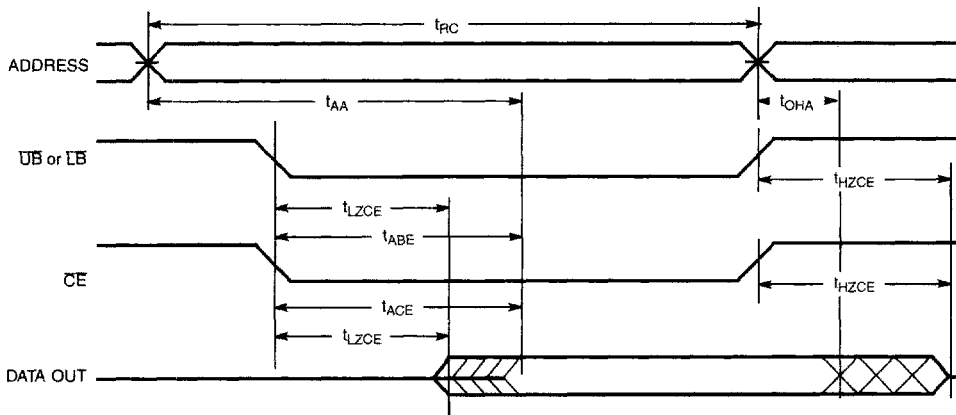

7C024-16

Notes:

18. R/W is HIGH for read cycles.
19. Device is continuously selected $\overline{CE} = V_{IL}$ and \overline{UB} or $\overline{LB} = V_{IL}$. This waveform cannot be used for semaphore reads.
20. $\overline{OE} = V_{IL}$.
21. Address valid prior to or coincident with \overline{CE} transition LOW.
22. To access RAM, $\overline{CE} = V_{IL}$, \overline{UB} or $\overline{LB} = V_{IL}$, $\overline{SEM} = V_{IH}$. To access semaphore, $\overline{CE} = V_{IH}$, $\overline{SEM} = V_{IL}$.

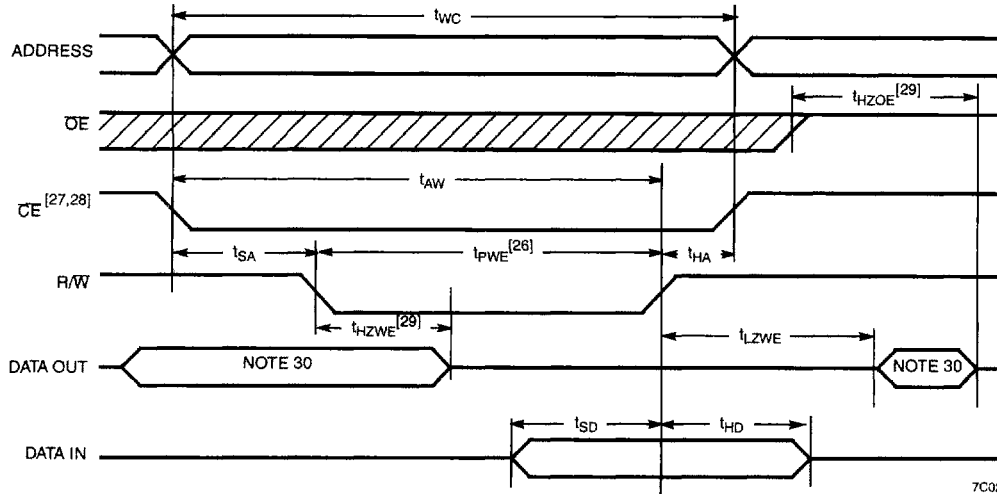
Switching Waveforms (continued)
Write Cycle No.1: R/W Controlled Timing^[23,24,25,26]

7C024-17

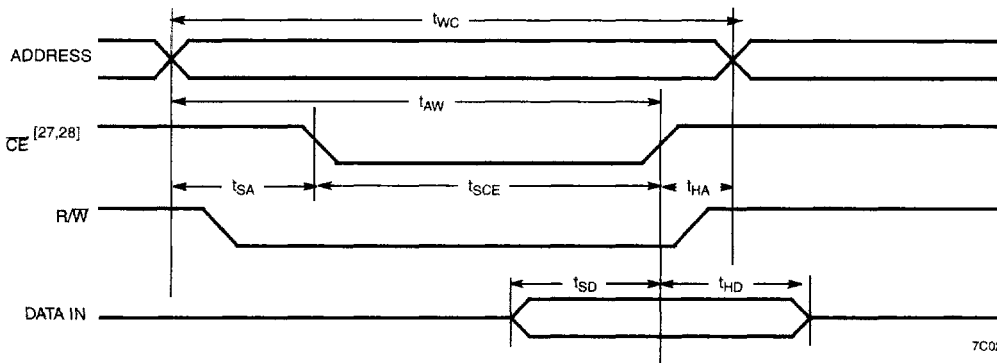
Write Cycle No. 2: CE Controlled Timing^[23,24,25,31]

7C024-18

Notes:

23. R/W must be HIGH during all address transitions.
24. A write occurs during the overlap (t_{SCE} or t_{PWE}) of a LOW CE or SEM and a LOW UB or LB.
25. t_{HA} is measured from the earlier of CE or R/W or (SEM or R/W) going HIGH at the end of write cycle.
26. If OE is LOW during a R/W controlled write cycle, the write pulse width must be the larger of t_{PWE} or ($t_{HZWE} + t_{SD}$) to allow the I/O drivers to turn off and data to be placed on the bus for the required t_{SD} . If OE is HIGH during an R/W controlled write cycle, this requirement does not apply and the write pulse can be as short as the specified t_{PWE} .
27. To access RAM, CE = V_{IL} , SEM = V_{IH} .
28. To access upper byte, CE = V_{IL} , UB = V_{IL} , SEM = V_{IH} .
To access lower byte, CE = V_{IL} , LB = V_{IL} , SEM = V_{IH} .
29. Transition is measured ± 500 mV from steady state with a 5-pF load (including scope and jig). This parameter is sampled and not 100% tested.
30. During this period, the I/O pins are in the output state, and input signals must not be applied.
31. If the CE or SEM LOW transition occurs simultaneously with or after the R/W LOW transition, the outputs remain in the high-impedance state.

3

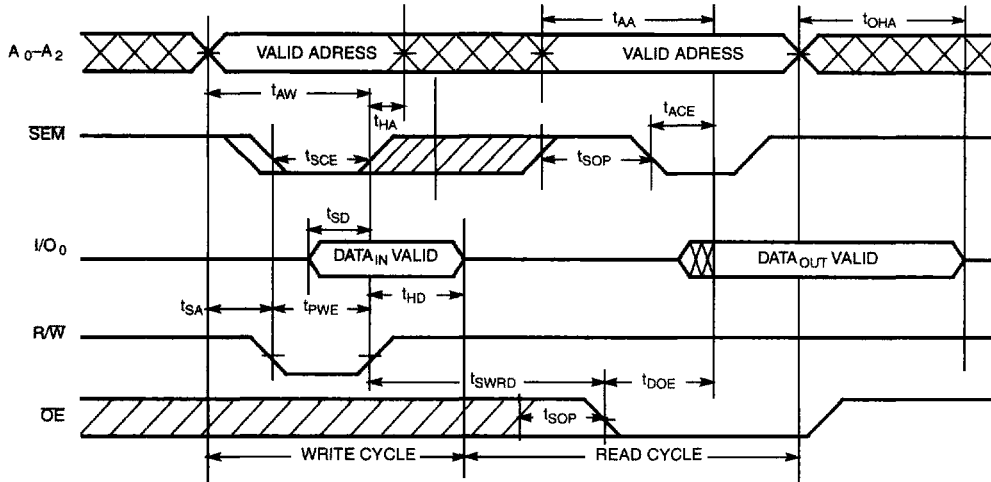
Switching Waveforms (continued)
Semaphore Read After Write Timing, Either Side^[32]

7C024-19

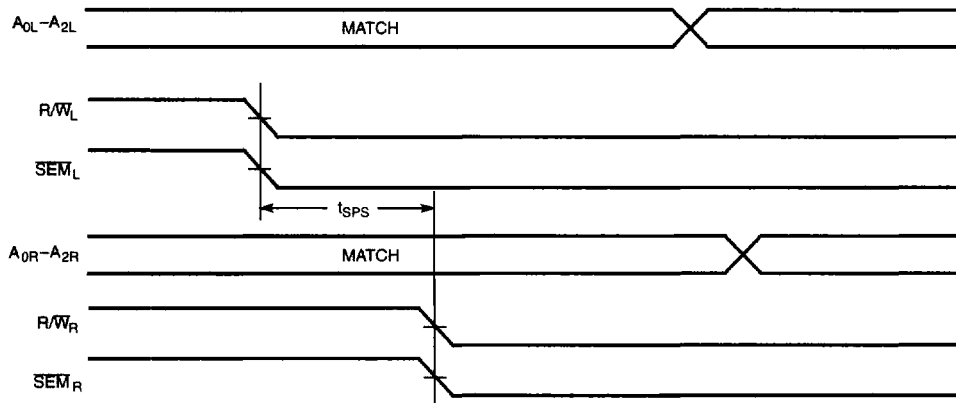
Timing Diagram of Semaphore Contention^[33,34,35]

7C024-20

Notes:

32. CE = HIGH for the duration of the above timing (both write and read cycle).
33. I/O_{0P} = I/O_{0L} = LOW (request semaphore); CE_R = CE_L = HIGH.
34. Semaphores are reset (available to both ports) at cycle start.
35. If t_{SPS} is violated, the semaphore will definitely be obtained by one side or the other, but which side will get the semaphore is unpredictable.

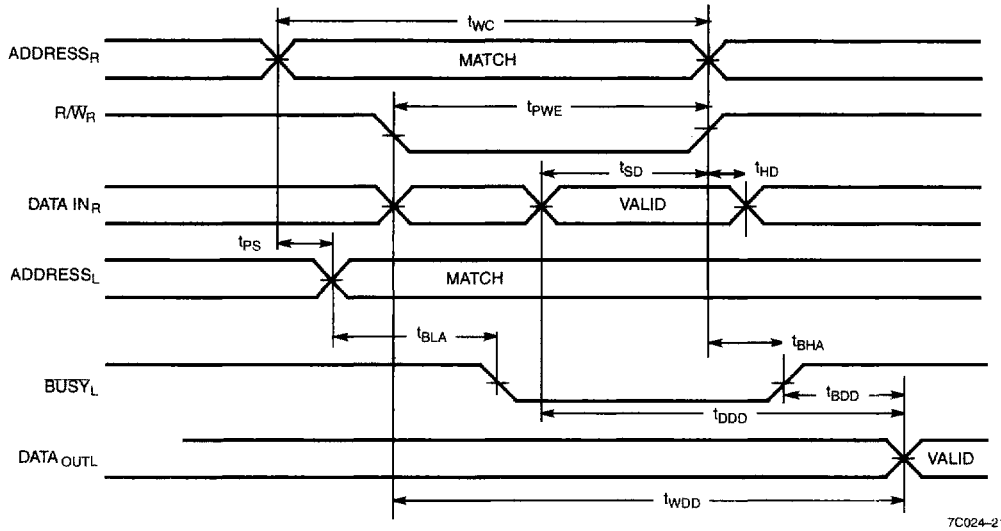
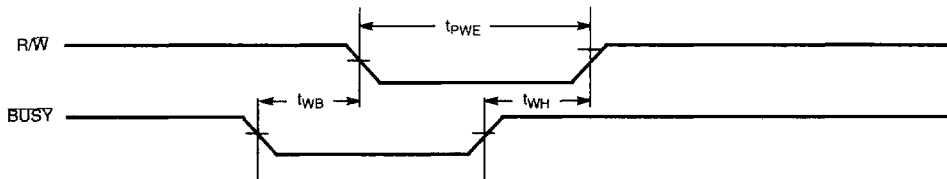
Switching Waveforms (continued)
Timing Diagram of Read with BUSY (M/S=HIGH)^[36]

Write Timing with Busy Input (M/S=LOW)

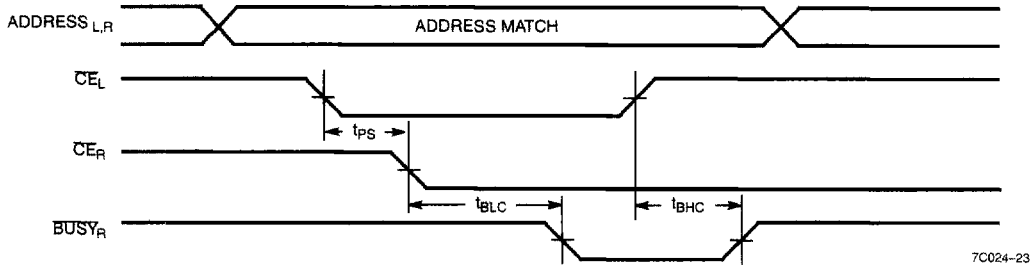
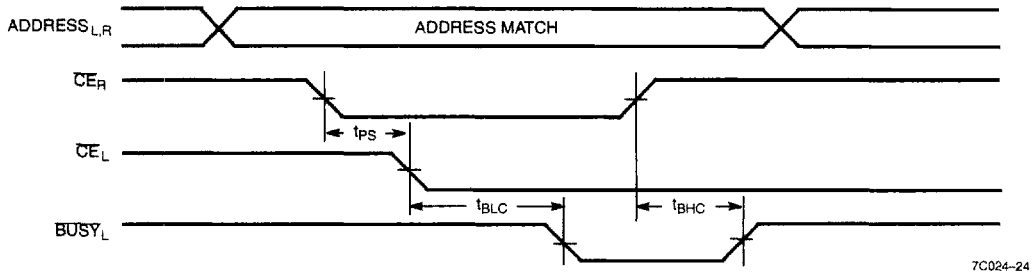
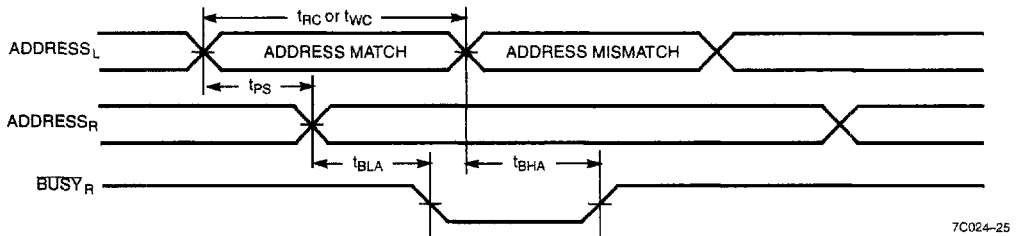
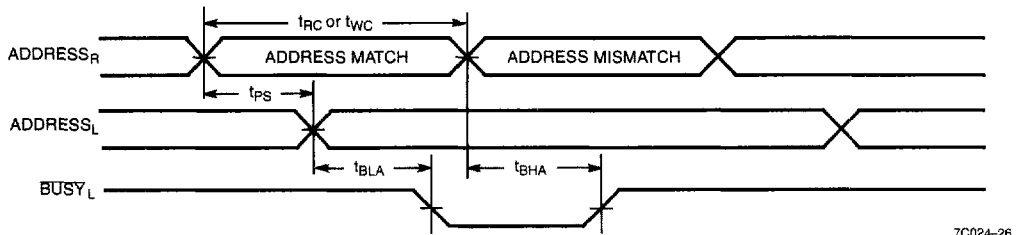
Note:
 36 $\overline{CE}_L = \overline{CE}_R = \text{LOW}$.

Switching Waveforms (continued)
Busy Timing Diagram No.1 (CE Arbitration)^[37]
CE_L Valid First:

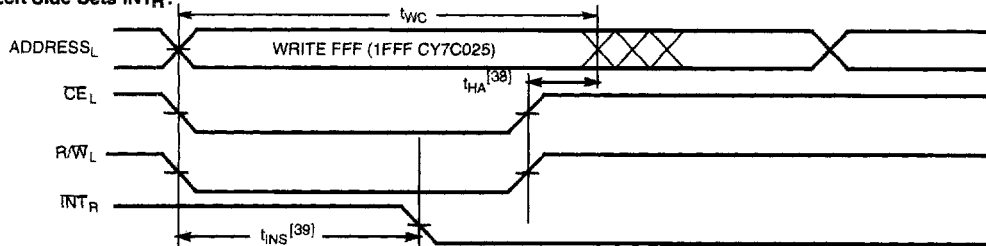
CE_R Valid First:

Busy Timing Diagram No.2 (Address Arbitration)^[37]
Left Address Valid First:

Right Address Valid First:

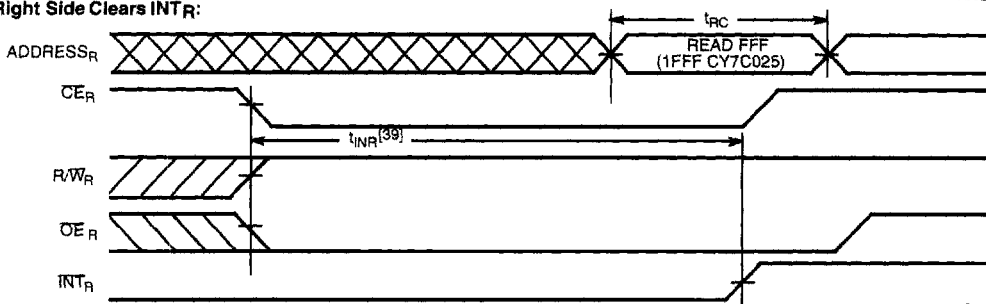
Note:

 37. If t_{PS} is violated, the busy signal will be asserted on one side or the other, but there is no guarantee to which side **BUSY** will be asserted.

Switching Waveforms (continued)
Interrupt Timing Diagrams
Left Side Sets INT_R:

7C024-27

Right Side Clears INT_R:

7C024-28

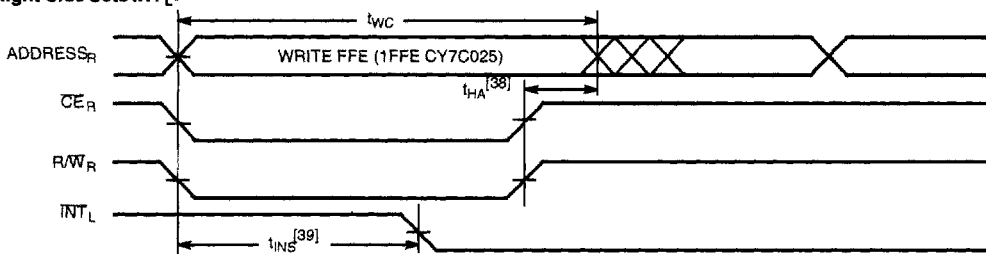
Right Side Sets INT_L:

7C024-29

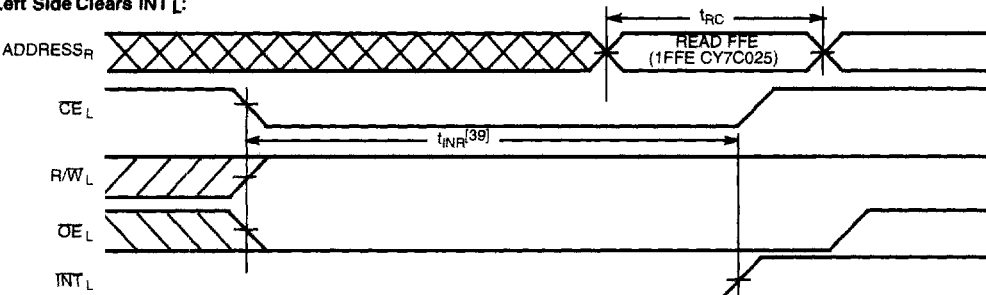
Left Side Clears INT_L:

7C024-30

Notes:

38. t_{HA} depends on which enable pin (CE_L or R/W_L) is deasserted first.
 39. t_{INS} or t_{INR} depends on which enable pin (CE_L or R/W_L) is asserted last.

3



Architecture

The CY7C024/0241 and CY7C025/0251 consist of an array of 4K words of 16/18 bits each and 8K words of 16/18 bits each of dual-port RAM cells, I/O and address lines, and control signals (CE, OE, R/W). These control pins permit independent access for reads or writes to any location in memory. To handle simultaneous writes/reads to the same location, a BUSY pin is provided on each port. Two interrupt (INT) pins can be utilized for port-to-port communication. Two semaphore (SEM) control pins are used for allocating shared resources. With the M/S pin, the CY7C024/0241 and CY7C025/0251 can function as a master (BUSY pins are outputs) or as a slave (BUSY pins are inputs). The CY7C024/0241 and CY7C025/0251 have an automatic power-down feature controlled by CE. Each port is provided with its own output enable control (OE), which allows data to be read from the device.

Functional Description

Write Operation

Data must be set up for a duration of t_{SD} before the rising edge of R/W in order to guarantee a valid write. A write operation is controlled by either the R/W pin (see Write Cycle No. 1 waveform) or the CE pin (see Write Cycle No. 2 waveform). Required inputs for non-contention operations are summarized in Table 1.

If a location is being written to by one port and the opposite port attempts to read that location, a port-to-port flowthrough delay must occur before the data is read on the output; otherwise the data read is not deterministic. Data will be valid on the port t_{DD} after the data is presented on the other port.

Read Operation

When reading the device, the user must assert both the OE and CE pins. Data will be available t_{ACE} after CE or t_{DOE} after OE is asserted. If the user of the CY7C024/0241 or CY7C025/0251 wishes to access a semaphore flag, then the SEM pin must be asserted instead of the CE pin, and OE must also be asserted.

Interrupts

The upper two memory locations may be used for message passing. The highest memory location (FFF for the CY7C024/0241, 1FFF for the CY7C025/0251) is the mailbox for the right port and the second-highest memory location (FFE for the CY7C024/0241, 1FFE for the CY7C025/0251) is the mailbox for the left port. When one port writes to the other port's mailbox, an interrupt is generated to the owner. The interrupt is reset when the owner reads the contents of the mailbox. The message is user defined.

Each port can read the other port's mailbox without resetting the interrupt. The active state of the BUSY signal (to a port) prevents the port from setting the interrupt to the winning port. Also, an active BUSY to a port prevents that port from reading its own mailbox and thus resetting the interrupt to it.

If your application does not require message passing, do not connect the interrupt pin to the processor's interrupt request input pin.

The operation of the interrupts and their interaction with Busy are summarized in Table 2.

Busy

The CY7C024/0241 and CY7C025/0251 provide on-chip arbitration to resolve simultaneous memory location access (con-

tenion). If both ports' CEs are asserted and an address match occurs within t_{PS} of each other, the busy logic will determine which port has access. If t_{PS} is violated, one port will definitely gain permission to the location, but which one is not predictable. BUSY will be asserted t_{BLA} after an address match or t_{BLC} after CE is taken LOW.

Master/Slave

A M/S pin is provided in order to expand the word width by configuring the device as either a master or a slave. The BUSY output of the master is connected to the BUSY input of the slave. This will allow the device to interface to a master device with no external components. Writing to slave devices must be delayed until after the BUSY input has settled (t_{BLC} or t_{BLA}). Otherwise, the slave chip may begin a write cycle during a contention situation. When tied HIGH, the M/S pin allows the device to be used as a master and, therefore, the BUSY line is an output. BUSY can then be used to send the arbitration outcome to a slave.

Semaphore Operation

The CY7C024/0241 and CY7C025/0251 provide eight semaphore latches, which are separate from the dual-port memory locations. Semaphores are used to reserve resources that are shared between the two ports. The state of the semaphore indicates that a resource is in use. For example, if the left port wants to request a given resource, it sets a latch by writing a zero to a semaphore location. The left port then verifies its success in setting the latch by reading it. After writing to the semaphore, SEM or OE must be deasserted for t_{SDP} before attempting to read the semaphore. The semaphore value will be available $t_{SWRD} + t_{DOE}$ after the rising edge of the semaphore write. If the left port was successful (reads a zero), it assumes control of the shared resource, otherwise (reads a one) it assumes the right port has control and continues to poll the semaphore. When the right side has relinquished control of the semaphore (by writing a one), the left side will succeed in gaining control of the semaphore. If the left side no longer requires the semaphore, a one is written to cancel its request.

Semaphores are accessed by asserting SEM LOW. The SEM pin functions as a chip select for the semaphore latches (CE must remain HIGH during SEM LOW). A_{0-2} represents the semaphore address. OE and R/W are used in the same manner as a normal memory access. When writing or reading a semaphore, the other address pins have no effect.

When writing to the semaphore, only I/O₀ is used. If a zero is written to the left port of an available semaphore, a one will appear at the same semaphore address on the right port. That semaphore can now only be modified by the side showing zero (the left port in this case). If the left port now relinquishes control by writing a one to the semaphore, the semaphore will be set to one for both sides. However, if the right port had requested the semaphore (written a zero) while the left port had control, the right port would immediately own the semaphore as soon as the left port released it. Table 3 shows sample semaphore operations.

When reading a semaphore, all sixteen/eighteen data lines output the semaphore value. The read value is latched in an output register to prevent the semaphore from changing state during a write from the other port. If both ports attempt to access the semaphore within t_{SPS} of each other, the semaphore will definitely be obtained by one side or the other, but there is no guarantee which side will control the semaphore.



Table 1. Non-Contending Read/Write

Inputs						Outputs		Operation
CE	R/W	OE	UB	LB	SEM	I/O ₀ -I/O ₇ ^[2]	I/O ₈ -I/O ₁₅ ^[3]	
H	X	X	X	X	H	High Z	High Z	Deselected: Power-Down
X	X	X	H	H	H	High Z	High Z	Deselected: Power-Down
L	L	X	L	H	H	High Z	Data In	Write to Upper Byte Only
L	L	X	H	L	H	Data In	High Z	Write to Lower Byte Only
L	L	X	L	L	H	Data In	Data In	Write to Both Bytes
L	H	L	L	H	H	High Z	Data Out	Read Upper Byte Only
L	H	L	H	L	H	Data Out	High Z	Read Lower Byte Only
L	H	L	L	L	H	Data Out	Data Out	Read Both Bytes
X	X	H	X	X	X	High Z	High Z	Outputs Disabled
H	H	L	X	X	L	Data Out	Data Out	Read Data in Semaphore Flag
X	H	L	H	H	L	Data Out	Data Out	Read Data in Semaphore Flag
H		X	X	X	L	Data In	Data In	Write D _{IN0} into Semaphore Flag
X		X	H	H	L	Data In	Data In	Write D _{IN0} into Semaphore Flag
L	X	X	L	X	L			Not Allowed
L	X	X	X	L	L			Not Allowed

3

Table 2. Interrupt Operation Example (assumes BUSY_L=BUSY_R=HIGH)^[40]

Function	Left Port					Right Port				
	R/W _L	CE _L	OE _L	A _{0L-11L}	INT _L	R/W _R	CE _R	OE _R	A _{0R-11R}	INT _R
Set Right INT _R Flag	L	L	X	(1)FFF	X	X	X	X	X	L ^[42]
Reset Right INT _R Flag	X	X	X	X	X	X	L	L	(1)FFF	H ^[41]
Set Left INT _L Flag	X	X	X	X	L ^[41]	L	L	X	(1)FFE	X
Reset Left INT _L Flag	X	L	L	(1)FFE	H ^[42]	X	X	X	X	X

Table 3. Semaphore Operation Example

Function	I/O ₀ -I/O _{15/17} Left	I/O ₀ -I/O _{15/17} Right	Status
No action	1	1	Semaphore free
Left port writes 0 to semaphore	0	1	Left Port has semaphore token
Right port writes 0 to semaphore	0	1	No change. Right side has no write access to semaphore.
Left port writes 1 to semaphore	1	0	Right port obtains semaphore token
Left port writes 0 to semaphore	1	0	No change. Left port has no write access to semaphore
Right port writes 1 to semaphore	0	1	Left port obtains semaphore token
Left port writes 1 to semaphore	1	1	Semaphore free
Right port writes 0 to semaphore	1	0	Right port has semaphore token
Right port writes 1 to semaphore	1	1	Semaphore free
Left port writes 0 to semaphore	0	1	Left port has semaphore token
Left port writes 1 to semaphore	1	1	Semaphore free

Notes:

- 40. A_{0L-12L} and A_{0R-12R}, 1FFF/1FFE for the CY7C025.
- 41. If BUSY_R=L, then no change.
- 42. If BUSY_L=L, then no change.



Ordering Information

4K x16 Dual-Port SRAM

Speed (ns)	Ordering Code	Package Name	Package Type	Operating Range
15	CY7C024-15AC	A100	100-Pin Thin Quad Flat Pack	Commercial
	CY7C024-15JC	J83	84-Lead Plastic Leaded Chip Carrier	
25	CY7C024-25AC	A100	100-Pin Thin Quad Flat Pack	Commercial
	CY7C024-25JC	J83	84-Lead Plastic Leaded Chip Carrier	Industrial
	CY7C024-25AI	A100	100-Pin Thin Quad Flat Pack	
	CY7C024-25JI	J83	84-Lead Plastic Leaded Chip Carrier	
35	CY7C024-35AC	A100	100-Pin Thin Quad Flat Pack	Commercial
	CY7C024-35JC	J83	84-Lead Plastic Leaded Chip Carrier	Industrial
	CY7C024-35AI	A100	100-Pin Thin Quad Flat Pack	
	CY7C024-35JI	J83	84-Lead Plastic Leaded Chip Carrier	
55	CY7C024-55AC	A100	100-Pin Thin Quad Flat Pack	Commercial
	CY7C024-55JC	J83	84-Lead Plastic Leaded Chip Carrier	Industrial
	CY7C024-55AI	A100	100-Pin Thin Quad Flat Pack	
	CY7C024-55JI	J83	84-Lead Plastic Leaded Chip Carrier	

8K x 16 Dual-Port SRAM

Speed (ns)	Ordering Code	Package Name	Package Type	Operating Range
15	CY7C025-15AC	A100	100-Pin Thin Quad Flat Pack	Commercial
	CY7C025-15JC	J83	84-Lead Plastic Leaded Chip Carrier	
25	CY7C025-25AC	A100	100-Pin Thin Quad Flat Pack	Commercial
	CY7C025-25JC	J83	84-Lead Plastic Leaded Chip Carrier	Industrial
	CY7C025-25AI	A100	100-Pin Thin Quad Flat Pack	
	CY7C025-25JI	J83	84-Lead Plastic Leaded Chip Carrier	
35	CY7C025-35AC	A100	100-Pin Thin Quad Flat Pack	Commercial
	CY7C025-35JC	J83	84-Lead Plastic Leaded Chip Carrier	Industrial
	CY7C025-35AI	A100	100-Pin Thin Quad Flat Pack	
	CY7C025-35JI	J83	84-Lead Plastic Leaded Chip Carrier	
55	CY7C025-55AC	A100	100-Pin Thin Quad Flat Pack	Commercial
	CY7C025-55JC	J83	84-Lead Plastic Leaded Chip Carrier	Industrial
	CY7C025-55AI	A100	100-Pin Thin Quad Flat Pack	
	CY7C025-55JI	J83	84-Lead Plastic Leaded Chip Carrier	

4K x 18 Dual-Port SRAM

Speed (ns)	Ordering Code	Package Name	Package Type	Operating Range
15	CY7C0241-15AC	A100	100-Pin Thin Quad Flat Pack	Commercial
25	CY7C0241-25AC	A100	100-Pin Thin Quad Flat Pack	Commercial
	CY7C0241-25AI	A100	100-Pin Thin Quad Flat Pack	Industrial
35	CY7C0241-35AC	A100	100-Pin Thin Quad Flat Pack	Commercial
	CY7C0241-35AI	A100	100-Pin Thin Quad Flat Pack	Industrial
55	CY7C0241-55AC	A100	100-Pin Thin Quad Flat Pack	Commercial
	CY7C0241-55AI	A100	100-Pin Thin Quad Flat Pack	Industrial



Ordering Information (continued)

8K x 18 Dual-Port SRAM

Speed (ns)	Ordering Code	Package Name	Package Type	Operating Range
15	CY7C0251-15AC	A100	100-Pin Thin Quad Flat Pack	Commercial
25	CY7C0251-25AC	A100	100-Pin Thin Quad Flat Pack	Commercial
	CY7C0251-25AI	A100	100-Pin Thin Quad Flat Pack	Industrial
35	CY7C0251-35AC	A100	100-Pin Thin Quad Flat Pack	Commercial
	CY7C0251-35AI	A100	100-Pin Thin Quad Flat Pack	Industrial
55	CY7C0251-55AC	A100	100-Pin Thin Quad Flat Pack	Commercial
	CY7C0251-55AI	A100	100-Pin Thin Quad Flat Pack	Industrial

Document #: 38-00255-B