

SML-01 Series

3020 (1208)
3.0 × 2.0mm (t=1.3mm)

Features

- Reflector type (3.0 × 2.0mm, t=1.3mm)
- Reflector improved the concentration of viewing angle and luminous intensity to the front direction



Specifications

Part No.	Chip Structure	Emitting Color	Absolute Maximum Ratings (Ta=25°C)					Electrical and Optical Characteristics (Ta=25°C)											
			Power Dissipation Pd (mW)	Forward Current If (mA)	Peak Forward Current Ifp (mA)	Reverse Voltage Vr (V)	Operating Temperature Topr (°C)	Storage Temperature Tstg (°C)	Forward Voltage V _F (V)	Reverse Current I _R (μA)	Dominant Wavelength λ _D (nm)			Luminous Intensity I _v (mcd)					
■ SML-012VT(A)	AlGaInP on GaAs	Red	75	30			-40 to +100			2.0			626	630	636	35.5	71		
■ SML-012V8T			54	20			-40 to +85			2.2			625	635		25	63		
■ SML-013UT			75	30			-30 to +85			2.0			619	624	629	90	220		
■ SML-012U8T			54	20			-40 to +85			2.2						40	100		
■ SML-012UT			75	30			-40 to +100			2.0			615	620	625	36	100		
■ SML-011UT																	22	63	
■ SML-012D8T					54	20			-40 to +85		2.2						63	160	
■ SML-012DT				Orange			100*1							602	605	608	36	100	
■ SML-011DT			75	30			-40 to +100		2.0	10					22	63			
■ SML-012WT(A)															140	280			
■ SML-012Y8T			54	20					2.2						40	100			
■ SML-013YT		Yellow				5	-40 to +85	-40 to +100	2.1	20	5	587	590	593	20	100	250	20	
■ SML-012YT			75	30					2.0						36	100			
■ SML-011YT															22	63			
■ SML-012M8T		Yellowish Green	54	20			-40 to +85		2.2			569	572	575	16	40			
■ SML-012P8T		Green										557	560	563	2.5	6.3			
■ SML-012PT(A)			62	25	60*1		-40 to +100		2.1			558	564		9	18			
■ SML012ECT		Bluish Green	84						3.3			520	525	535	140	360			
■ SML012EC4T									3.2						56	140			
■ SML013BDT	InGaN	Blue	78	20	100*1		-30 to +85			100					90	250			
■ SML012BCT									3.3			465	470	475	36	100			
■ SML012BC4T				84						3.2						22	36		
□ SML013WBDW		White										(x, y)	(0.30, 0.30)		360	900			

Dimensions

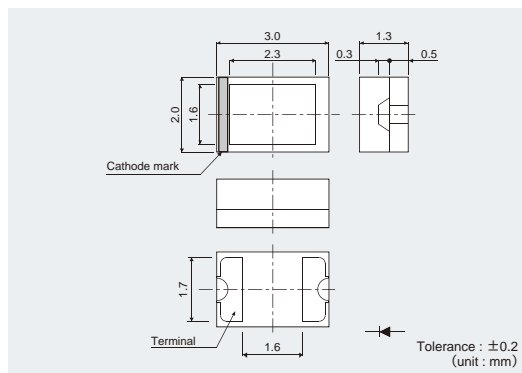

Recommended Solder Pattern Viewing Angle

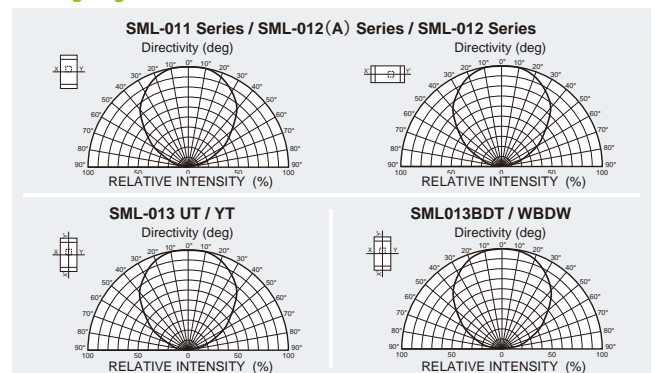
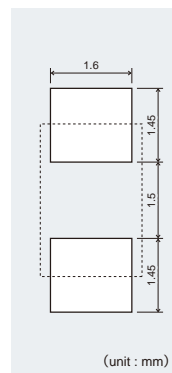

* 1: Duty 1/10, 1kHz / * 2: Reference

Electrical Characteristics Curves

Forward Current-Forward Voltage

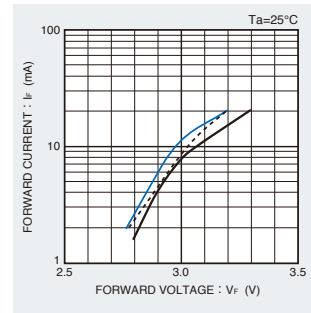
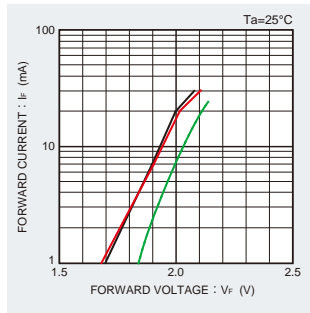
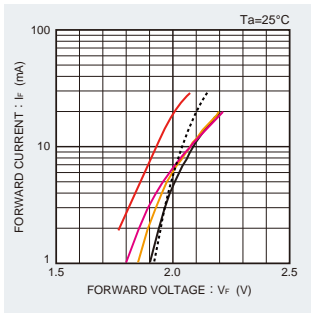

Luminous Intensity-Atmosphere Temperature

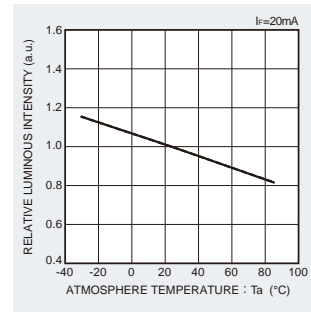
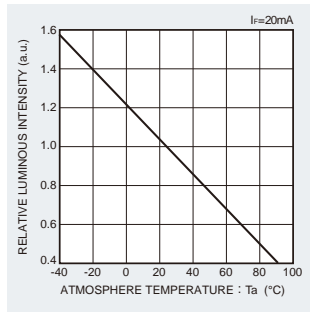
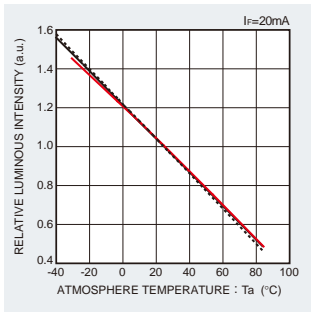

Luminous Intensity-Forward Current

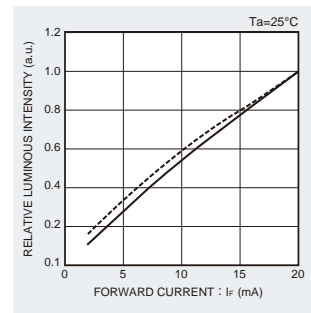
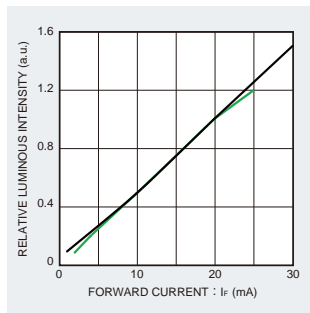
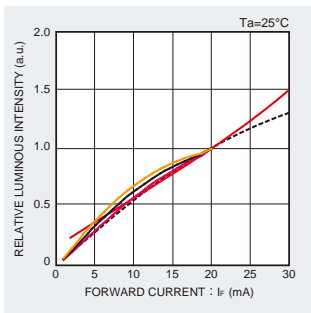

Derating

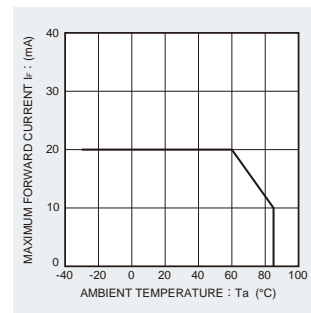
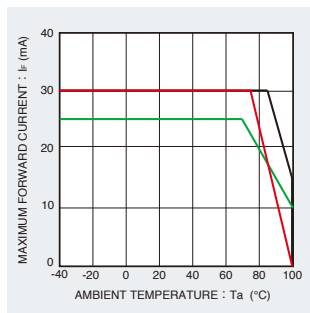
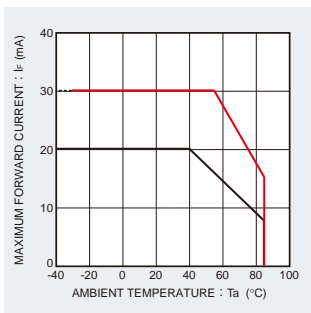

SML-01 series

Rank Reference of Brightness

Red (V, U)

(Ta=25°C, If=20mA)

Package size(mm)	Height(mm)	Luminous Intensity (mcd)	J	K	L	M	N	P	Q	R	S	T	U	V	W	X				
			2.5 to 4.0	4.0 to 6.3	6.3 to 10	10 to 16	16 to 25	25 to 40	40 to 63	63 to 100	100 to 160	160 to 250	250 to 400	400 to 630	630 to 1000	1000 to 1600				
Chip LEDs with reflector	3020	1.3	SML-012V8T																	
													SML-013UT							
													SML-012U8T							
													SML-012UT*							
										SML-011UT*										

※Brightness on specification sheet include tolerance of within ±10%.

Orange (D)

(Ta=25°C, If=20mA)

Package size(mm)	Height(mm)	Luminous Intensity (mcd)	J	K	L	M	N	P	Q	R	S	T	U	V	W	X			
			2.5 to 4.0	4.0 to 6.3	6.3 to 10	10 to 16	16 to 25	25 to 40	40 to 63	63 to 100	100 to 160	160 to 250	250 to 400	400 to 630	630 to 1000	1000 to 1600			
Chip LEDs with reflector	3020	1.3	SML-011DT*																
													SML-012D8T						
													SML-012DT*						

※Brightness on specification sheet include tolerance of within ±10%.

Yellow (Y)

(Ta=25°C, If=20mA)

Package size(mm)	Height(mm)	Luminous Intensity (mcd)	J	K	L	M	N	P	Q	R	S	T	U	V	W	X			
			2.5 to 4.0	4.0 to 6.3	6.3 to 10	10 to 16	16 to 25	25 to 40	40 to 63	63 to 100	100 to 160	160 to 250	250 to 400	400 to 630	630 to 1000	1000 to 1600			
Chip LEDs with reflector	3020	1.3	SML-011YT*																
													SML-012Y8T						
													SML-012YT*						
													SML-013YT						

※Brightness on specification sheet include tolerance of within ±10%.

Green (M, P, E)

(Ta=25°C, If=20mA)

Package size(mm)	Height(mm)	Luminous Intensity (mcd)	J	K	L	M	N	P	Q	R	S	T	U	V	W	X				
			2.5 to 4.0	4.0 to 6.3	6.3 to 10	10 to 16	16 to 25	25 to 40	40 to 63	63 to 100	100 to 160	160 to 250	250 to 400	400 to 630	630 to 1000	1000 to 1600				
Chip LEDs with reflector	3020	1.3	SML-012P8T																	
													SML-012M8T							
													SML012EC4T*							
										SML012ECT*										

※Brightness on specification sheet include tolerance of within ±10%.

Blue (B)

(Ta=25°C, If=20mA)

Package size(mm)	Height(mm)	Luminous Intensity (mcd)	G	H	J	K	L	M	N	P	Q	R	S	T	U	V	W		
			0.9 to 1.4	1.4 to 2.2	2.2 to 3.6	3.6 to 5.6	5.6 to 9.0	9 to 14	14 to 22	22 to 36	36 to 56	56 to 90	90 to 140	140 to 220	220 to 360	360 to 560	560 to 900		
Chip LEDs with Reflector	3020	1.3	SML012BC4T																
													SML012BCT						
													SML013BDT						

White (WB)

(Ta=25°C, If=5mA)

Package size(mm)	Height(mm)	Luminous Intensity (mcd)	P	Q	R	S	T	U	V	W	X1	X2	Y1	Y2	Z1
			25 to 36	36 to 56	56 to 90	90 to 140	140 to 220	220 to 360	360 to 560	560 to 900	900 to 1100	1100 to 1400	1400 to 1800	1800 to 2200	2200 to 2800
Chip LEDs with reflector	3020	1.3	SML013WBDW												

SML-012(A)

(Ta=25°C, If=20mA)

Package size(mm)	Height(mm)	Luminous Intensity (mcd)	AG	AH	AJ	AK	AL	AM	AN	AP	AQ	AR	AS	AT	AU	AV	AW	AX	AY	AZ		
			9.0 to 11.2	11.2 to 14	14 to 18	18 to 22.4	22.4 to 28	28 to 35.5	35.5 to 45	45 to 56	56 to 71	71 to 90	90 to 112	112 to 140	140 to 180	180 to 224	224 to 280	280 to 355	355 to 450	450 to 560		
Chip LEDs with Reflector	3020	1.3	SML-012PT(A)*										SML-012VT(A)					SML-012WT(A)*				

* Please note that the brightness of some products may fall between ranks (half rank).

Chromaticity Diagram (White)

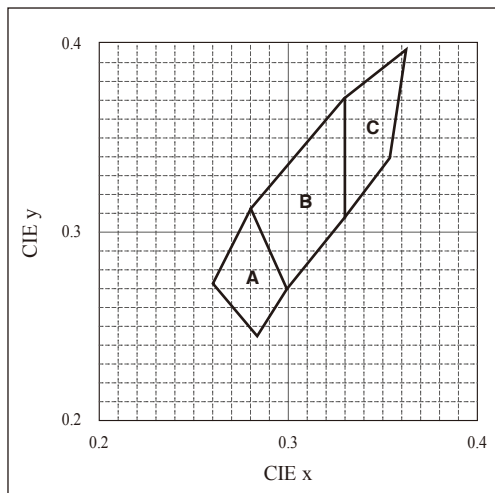

Part No. Construction

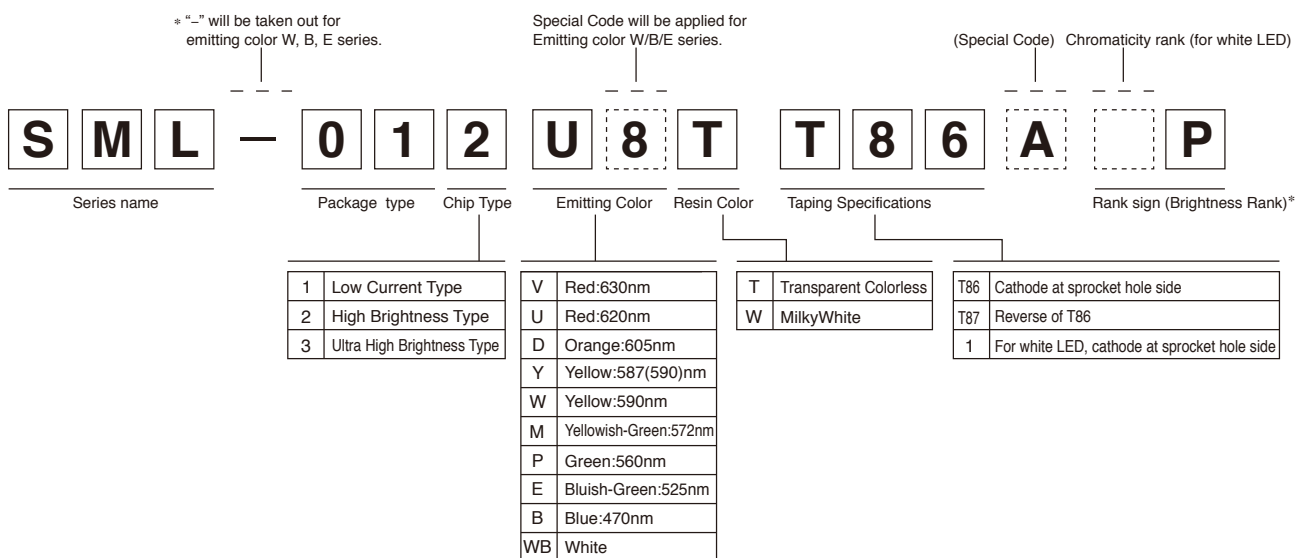

- * Concerning the Brightness rank
 - Please refer to the rank chart above for luminous intensity classification.
 - Part name is individual for each rank.
 - When shipped as sample, the part name will be a representative part name.
- General products are free of ranks. Please contact sales if rank appointment is needed.

Packing Specification

ROHM LED products are being shipped with desiccant (silica gel) concluded in moisture-proof bags. Pasting the moisture sensitive label on the outer surface of the moisture-proof bags or enclosing the humidity indication card inside the bag is available upon request. Please contact the nearest sales office or distributor if necessary.

Notes

No copying or reproduction of this document, in part or in whole, is permitted without the consent of ROHM Co.,Ltd.

The content specified herein is subject to change for improvement without notice.

The content specified herein is for the purpose of introducing ROHM's products (hereinafter "Products"). If you wish to use any such Product, please be sure to refer to the specifications, which can be obtained from ROHM upon request.

Examples of application circuits, circuit constants and any other information contained herein illustrate the standard usage and operations of the Products. The peripheral conditions must be taken into account when designing circuits for mass production.

Great care was taken in ensuring the accuracy of the information specified in this document. However, should you incur any damage arising from any inaccuracy or misprint of such information, ROHM shall bear no responsibility for such damage.

The technical information specified herein is intended only to show the typical functions of and examples of application circuits for the Products. ROHM does not grant you, explicitly or implicitly, any license to use or exercise intellectual property or other rights held by ROHM and other parties. ROHM shall bear no responsibility whatsoever for any dispute arising from the use of such technical information.

The Products specified in this document are intended to be used with general-use electronic equipment or devices (such as audio visual equipment, office-automation equipment, communication devices, electronic appliances and amusement devices).

The Products specified in this document are not designed to be radiation tolerant.

While ROHM always makes efforts to enhance the quality and reliability of its Products, a Product may fail or malfunction for a variety of reasons.

Please be sure to implement in your equipment using the Products safety measures to guard against the possibility of physical injury, fire or any other damage caused in the event of the failure of any Product, such as derating, redundancy, fire control and fail-safe designs. ROHM shall bear no responsibility whatsoever for your use of any Product outside of the prescribed scope or not in accordance with the instruction manual.

The Products are not designed or manufactured to be used with any equipment, device or system which requires an extremely high level of reliability the failure or malfunction of which may result in a direct threat to human life or create a risk of human injury (such as a medical instrument, transportation equipment, aerospace machinery, nuclear-reactor controller, fuel-controller or other safety device). ROHM shall bear no responsibility in any way for use of any of the Products for the above special purposes. If a Product is intended to be used for any such special purpose, please contact a ROHM sales representative before purchasing.

If you intend to export or ship overseas any Product or technology specified herein that may be controlled under the Foreign Exchange and the Foreign Trade Law, you will be required to obtain a license or permit under the Law.



Thank you for your accessing to ROHM product informations.
More detail product informations and catalogs are available, please contact us.

ROHM Customer Support System

<http://www.rohm.com/contact/>