

# 2 • ROW Strip Connectors Board to Cable

.050"

**MA-2**

4 thru 128 Contacts

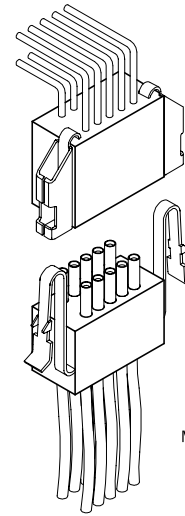

MA-241-010-261-A53WA

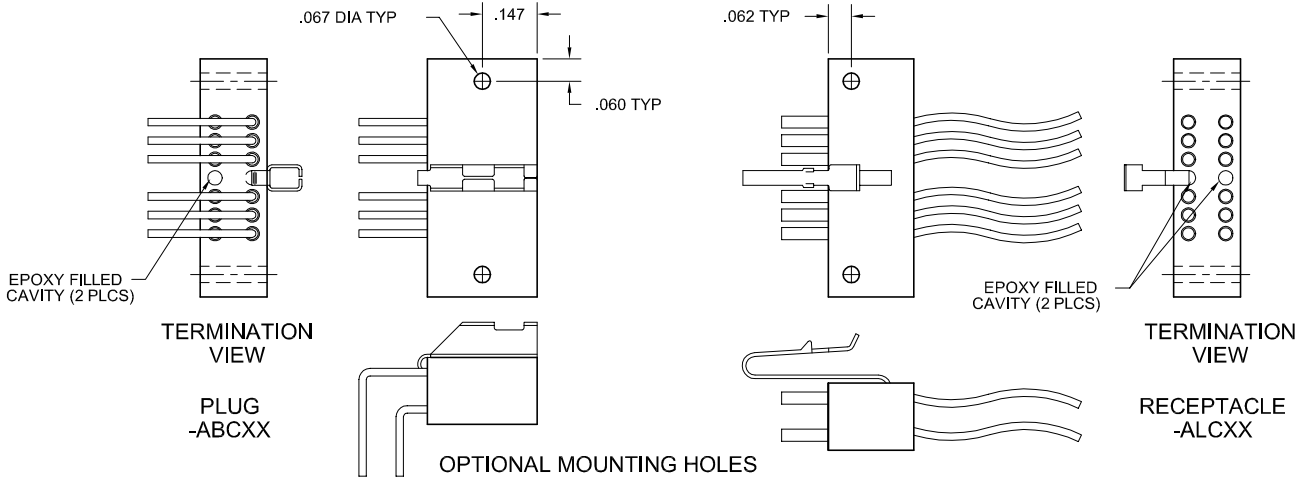
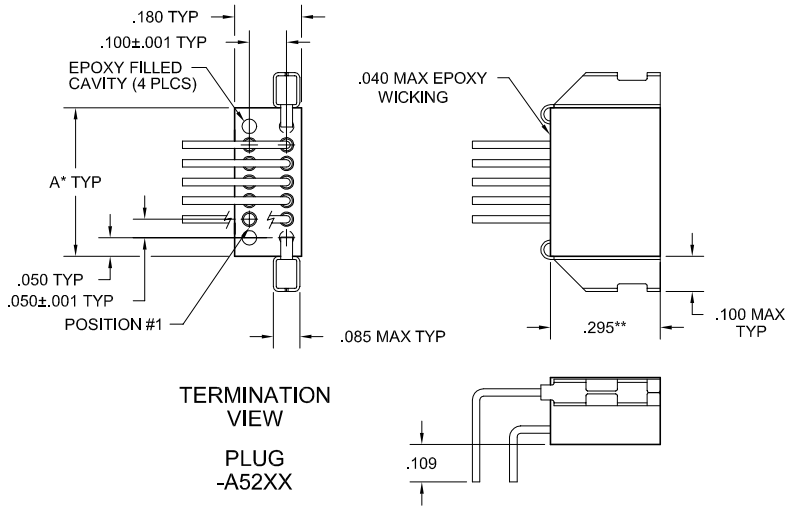

DIMENSIONS	
To determine connector length (Dim "A"):	
Multiply the number of cavities in one row by .050"	. "
Add fixed end lengths (constant, .025" x 2)	0.05"
Add .085" for each mounting hole	. "
Total Length:	. "
<b>Notes:</b>	
Length over 2" may require support to insure alignment	
* = Maximum length is 3.420". Maximum number of contacts must be reduced to accommodate hardware and mounting holes.	
** = For cable applications, .295" becomes .390"	
*** = For solder cup or board mount applications, .230" becomes .135"	

# 2 • ROW

## Strip Connectors with Latches

.050"

**MA-2**

4 thru 128 Contacts

### PLUG LATCH BOX

EXAMPLE: MA-231-012-161-A50WN

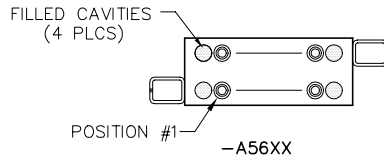
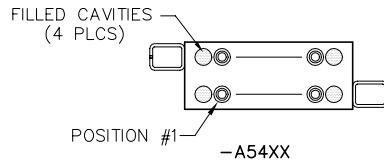
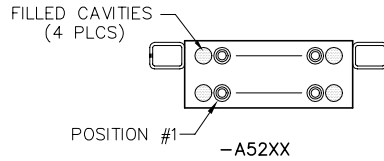
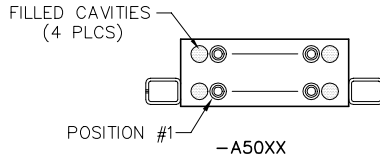

### RECEPTACLE LATCH SPRING

EXAMPLE: MA-241-012-261-A51WN

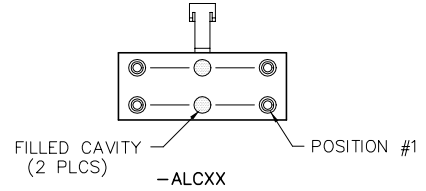
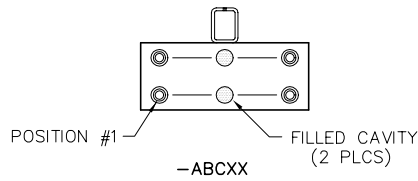
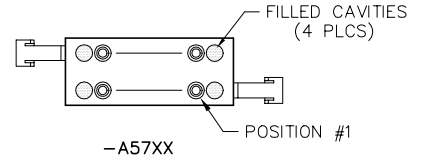
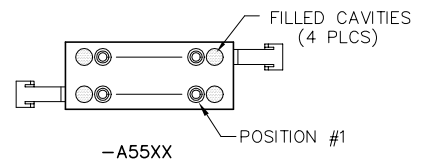
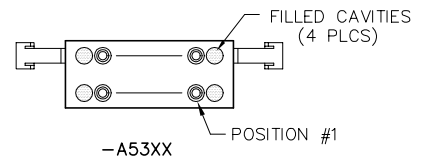
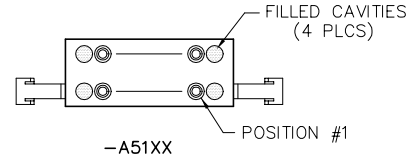

NOTE: ALL DRAWINGS VIEWED FROM MATING FACE

# MA Strip Guidelines

## For "A" designator in hardware portion of part number

1. Any cavity that has a contact is considered an electrical position (including dummy contact).
2. All hardware locations, holes and/or epoxy filled cavities are considered mechanical positions.
3. The cavity adjacent to a mechanical hole, in opposite row, will be an epoxy filled cavity (two row only).
4. Side mount latch will always be in row two of connector (two row only).
5. Connector must always have an even number of contacts for standard part number (two row only). Consult factory for non-standard requirements.
6. Omit holes on board layout for mechanical positions and renumber board layout accordingly, except connectors with mechanical position(s) in end cavity(ies). See board layout examples, pages M-29 thru M-34.
7. These guidelines apply for all hardware options, including guide holes (mechanical locations).
8. Do not skip wire colors on stranded wire assemblies.

### To determine hardware location number:

1. Divide the total number of cavities in one row by two (including hardware cavity).
2. Round to the next whole number if result is a fraction.

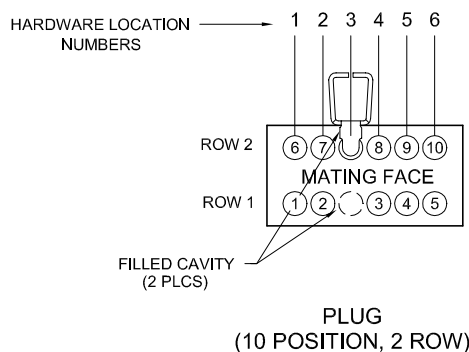

The connector above has 12 cavities with 10 live contacts.  
(10 electrical positions & 2 mechanical positions)

To determine the hardware location number:  
6 cavities (in one row) - 2 = 3  
Hardware would be placed in location #3.

**LEAD CONFIGURATION OPTIONS**

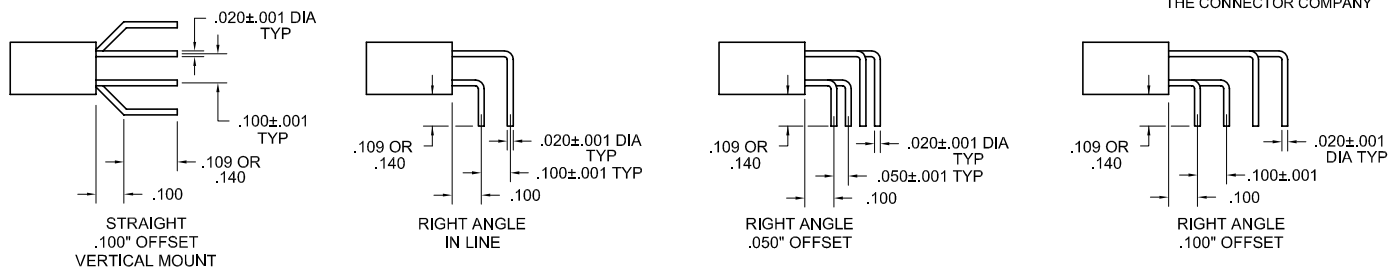

**PLUG:** MA-2F1-010-325-A5200  
**RECEPTACLE:** MA-241-010-261-A53WA  
 XX-XXX-XXX-XXX-XXXXX

**PLUG**

**RECEPTACLE**

SERIES	
MA .050" Microminiature Strip Connector	MA .050" Microminiature Strip Connector

BODY	
2 2-Row	2 2-Row

<b>BODY STYLE:</b> (Material: Polyphenylene sulfide)	<b>BODY STYLE:</b> (Material: Polyphenylene sulfide)
11 Plug, straight, with mounting holes	21 Receptacle, straight, with mounting holes
31 Plug, straight, without mounting holes	41 Receptacle, straight, without mounting holes
51 Plug, right angle, .050" offset, with mounting holes	61 Receptacle, right angle, .050" offset, with mounting holes
71 Plug, right angle, .100" offset, with mounting holes	81 Receptacle, right angle, .100" offset, with mounting holes
91 Plug, right angle, .050" offset, without mounting holes	A1 Receptacle, right angle, .050" offset, without mounting holes
B1 Plug, right angle, .100" offset, without mounting holes	C1 Receptacle, right angle, .100" offset, without mounting holes
D1 Plug, right angle, in line, with mounting holes	E1 Receptacle, right angle, in line, with mounting holes
F1 Plug, right angle, in line, without mounting holes	G1 Receptacle, right angle, in line, without mounting holes
H1 Plug, straight, .100" offset, without mounting holes	J1 Receptacle, straight, .100" offset, without mounting holes

SIZE	
XXX Number of contacts (004- 128)	XXX Number of contacts (004-128)

Note: Maximum number of contacts is reduced when using hardware or mounting holes. See dimension chart on M-25.

**CONTACTS**

<b>TYPE CONTACTS/TERMINATIONS:</b>	<b>TYPE CONTACTS/TERMINATIONS:</b>
11 Pin, straight, solder cup	21 Socket, straight, solder cup
12 Pin, straight, dip solder, .109"	22 Socket, straight, dip solder, .109"
13 Pin, straight, dip solder, .140"	23 Socket, straight, dip solder, .140"
14 Pin, straight, .500" pigtails (.018 dia)	24 Socket, straight, .500" pigtails (.018 dia)
15 Pin, straight, 1.000" pigtails (.018 dia)	25 Socket, straight, 1.000" pigtails (.018 dia)
16 Pin, straight, crimped wire	26 Socket, straight, crimped wire
32 Pin, right angle, dip solder, .109"	43 Socket, right angle, dip solder, .109"
33 Pin, right angle, dip solder, .140"	44 Socket, right angle, dip solder, .140"

<b>PLATING OPTIONS:</b>	<b>PLATING OPTIONS:</b>
1 50 μ" Au contacts (crimp wire)	1 50 μ" Au contacts (crimp wire)
3 50 μ" Au contacts; 10 μ" Au terminations (solder cup, pigtail)	3 50 μ" Au contacts; 10 μ" Au terminations (solder cup, pigtail)
5 50 μ" Au contacts; 100 μ" Sn alloy terminations (dip solder, pigtail)	5 50 μ" Au contacts; 100 μ" Sn alloy terminations (dip solder, pigtail)

**HARDWARE**

<b>STYLE OF HARDWARE:</b>	<b>STYLE OF HARDWARE:</b>
A00 None	A00 None
ABC Latch box, side mounted (centered)* See page M-27	ALC Latch spring, side mounted (centered)* See page M-27
A50 Latch boxes (two end cavities). See page M-27**	A51 Latch springs, (two end cavities). See page M-27**
A52 Latch boxes (two end cavities). See page M-27**	A53 Latch springs, (two end cavities). See page M-27**
A54 Latch boxes (two end cavities). See page M-27**	A55 Latch springs, (two end cavities). See page M-27**
A56 Latch boxes (two end cavities). See page M-27**	A57 Latch springs, (two end cavities). See page M-27**
A64 One guide hole (centered)*	A61 One guide pin (centered)*
A65 One guide hole (first cavity)	A62 One guide pin (first cavity)
A66 One guide hole (last cavity)	A63 One guide pin (last cavity)
A68 Two guide holes (first & last cavity)	A67 Two guide pins (first & last cavity)
AHX One guide hole (cavity #2 - #9)	APX One guide pin (cavity #2 - #9)

<b>POLARIZATION / WIRING:</b>	<b>POLARIZATION / WIRING:</b>
00 None	00 None
WX For wiring codes, see page MA-3 & MA-4	WX For wiring codes, see page MA-3 & MA-4

\* = To determine location, divide the total number of cavities (in one row) by two and round to the next whole number, if result is a fraction. See page M-28.  
 \*\* = Not available with mounting holes.  
 See MA strip guidelines, page M-28, for location examples & visual clarification.  
 Connector part number must have even number of contacts.  
 Consult factory for non-standard requirements.

## MIL-PRF-83513 Wire Codes

Wire Code	Mil-Spec Description
V1	M22759/11-26-( )= 18" long, color per MIL-PRF-83513
V2	M22759/11-26-( )= 36" long, color per MIL-PRF-83513
W1	M22759/11-26-9 = 18" long
W2	M22759/11-26-9 = 36" long
W3	M22759/11-26-( ) = 18" long
W4	M22759/11-26-( ) = 36" long
Y1	M22759/33-26-9 = 18" long
Y2	M22759/33-26-9 = 36" long
Y3	M22759/33-26-( ) = 18" long, color per MIL-PRF-83513
Y4	M22759/33-26-( ) = 36" long, color per MIL-PRF-83513
Y5	M22759/11-26-9 = 72" long
Y6	M22759/11-26-( )= 72" long, color per MIL-PRF-83513
Y7	M22759/33-26-9 = 72" long
Y8	M22759/33-26-( ) = 72" long, color per MIL-PRF-83513
X1	M22759/11-26-9 = 6" long
X2	M22759/11-26-9 =12" long
X3	M22759/11-26-( ) = 6" long
X4	M22759/11-26-( ) =12" long

## AirBorn Standard Wire Codes (in accordance with MIL-W-16878)

Wire Code	Wire Size	Wire Type	Wire Color	Wire Length (+1.0"/-0.0")
WA	24 awg	TFE 7-strand E	Per MIL-STD-681	6"
WB	24 awg	TFE 7-strand E	Per MIL-STD-681	12"
WC	24 awg	TFE 7-strand E	Per MIL-STD-681	18"
WD	24 awg	TFE 7-strand E	Per MIL-STD-681	36"
WE	24 awg	TFE 7-strand E	White	6"
WF	24 awg	TFE 7-strand E	White	12"
WG	24 awg	TFE 7-strand E	White	18"
WH	24 awg	TFE 7-strand E	White	36"
WJ	24 awg	TFE 7-strand E	Yellow	6"
WK	24 awg	TFE 7-strand E	Yellow	12"
WL	24 awg	TFE 7-strand E	Yellow	18"
WM	24 awg	TFE 7-strand E	Yellow	36"
WN	26 awg	TFE 7-strand E	Per MIL-STD-681	6"
WP	26 awg	TFE 7-strand E	Per MIL-STD-681	12"
WQ	26 awg	TFE 7-strand E	Per MIL-STD-681	18"
WR	26 awg	TFE 7-strand E	Per MIL-STD-681	36"
WS	26 awg	TFE 7-strand E	White	6"
WT	26 awg	TFE 7-strand E	White	12"
WU	26 awg	TFE 7-strand E	White	18"
WV	26 awg	TFE 7-strand E	White	36"
WW	26 awg	TFE 7-strand E	Yellow	6"
WX	26 awg	TFE 7-strand E	Yellow	12"
WY	26 awg	TFE 7-strand E	Yellow	18"
WZ	26 awg	TFE 7-strand E	Yellow	36"
XA	28 awg	TFE 7-strand E	Per MIL-STD-681	6"
XB	28 awg	TFE 7-strand E	Per MIL-STD-681	12"
XC	28 awg	TFE 7-strand E	Per MIL-STD-681	18"
XD	28 awg	TFE 7-strand E	Per MIL-STD-681	36"
XE	28 awg	TFE 7-strand E	White	6"
XF	28 awg	TFE 7-strand E	White	12"
XG	28 awg	TFE 7-strand E	White	18"
XH	28 awg	TFE 7-strand E	White	36"
XJ	28 awg	TFE 7-strand E	Yellow	6"
XK	28 awg	TFE 7-strand E	Yellow	12"
XL	28 awg	TFE 7-strand E	Yellow	18"
XM	28 awg	TFE 7-strand E	Yellow	36"