

MCX Miniature Coaxial Connectors

MCX Miniaturkoaxialkontakte

Technical Data

Technische Daten

Mechanical Data

Mechanische Daten

Mechanical Data <i>Mechanische Daten</i>	
Mating force <i>Steckkraft</i>	max. 24.9 N (5.6 lbs.)
Unmating force <i>Ziehkraft</i>	min. 8 N (1.8 lbs.)
Recommended temperature range <i>Empfohlener Temperaturbereich</i>	$-65\text{ °C} \leq \vartheta \leq 165\text{ °C}$ ($-85\text{ °F} \leq \vartheta \leq 329\text{ °F}$)
Mating cycles <i>Steckzyklen</i>	≥ 500

Electrical Data

Elektrische Daten

Electrical Data <i>Elektrische Daten</i>	
Characteristic impedance <i>Wellenwiderstand</i>	50 Ω / 75 Ω
Frequency range <i>Frequenzbereich</i>	0 - 6 GHz
Insulation resistance <i>Isolationswiderstand</i>	$\geq 5000\text{ M}\Omega$
Contact resistance inner conductor <i>Durchgangswiderstand Innenleiter</i>	$\leq 5\text{ m}\Omega$
Contact resistance outer conductor <i>Durchgangswiderstand Außenleiter</i>	$\leq 1\text{ m}\Omega$
Dielectric Withstanding Voltage (DWV) at sea level <i>Prüfspannung (DWV) auf Meereshöhe</i>	$\geq 1000\text{ VRSM}$

Materials and Platings

Materialien und Oberflächen

Materials and Platings <i>Materialien und Oberflächen</i>	
Body material <i>Kontaktmaterial</i>	Brass <i>Messing</i>
Material center conductor <i>Material Innenleiter</i>	CuBe / Brass <i>CuBe / Messing</i>
Insulator <i>Isolator</i>	Teflon <i>Teflon</i>
Crimp ferrule <i>Crimphülse</i>	Cu alloy <i>Cu Legierung</i>
Center contact plating <i>Oberfläche Innenleiter</i>	Au over Ni <i>Au über Ni</i>



MCX Coaxial Connectors, Mating Area Dimensions

MCX Koaxialkontakte, Abmessungen Steckbereich

Plug
Stift

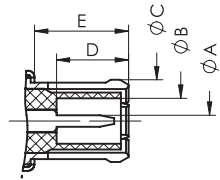

Jack
Buchse

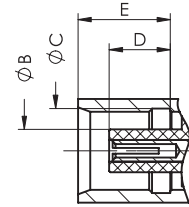

	Plug / <i>Stift</i>		Jack / <i>Buchse</i>	
	min.	max.	min.	max.
A	0,48 (0.019)	0,53 (0.021)	—	—
B	2,00 (0.079)	—	1,85 (0.073)	1,98 (0.078)
C	—	3,81 (0.150)	3,73 (0.147) ^{nom.}	
D	2,79 (0.110)	3,20 (0.126)	2,60 (0.102)	2,80 (0.110)
E	4,14 (0.163)	—	3,99 (0.157)	4,12 (0.162)

Dimensions Straight Cable Termination, Semi-rigid (MCX)

Abmessungen gerader Kabelanschluss, semi-rigid (MCX)

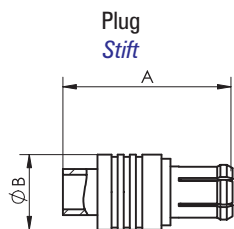

FCT Part Number <i>FCT Teilenummer</i>	A	B	Characteristic Impedance <i>Wellenwiderstand</i>	Suitable Cable <i>Verwendbares Kabel</i>
A25P1NA-103-10	11,2 (0.441)	5,0 (0.196)	50 Ohm	0.086 Semi-rigid
A25P1NA-104-10	13,8 (0.545)	5,0 (0.196)		0.141 Semi-rigid
A25P1NA-111-10	11,2 (0.441)	5,0 (0.196)		0.047 Semi-rigid
A25J1NA-103-10	11,9 (0.467)	5,0 (0.196)		.086 Semi-Rigid
A25J1NA-104-10	11,9 (0.467)	5,0 (0.196)		.141 Semi-rigid
A25J1NA-111-10	11,9 (0.467)	5,0 (0.196)		.047 Semi Rigid
A38P1NA-103-10	11,2 (0.441)	5,0 (0.196)	75 Ohm	RG405, .086 Semi-rigid
A38P1NA-104-10	13,8 (0.545)	5,0 (0.196)		0.141 Semi-rigid
A38J1NA-103-10	11,9 (0.467)	5,0 (0.196)		.086 Semi-Rigid
A38J1NA-104-10	11,9 (0.467)	5,0 (0.196)		.141 Semi-rigid

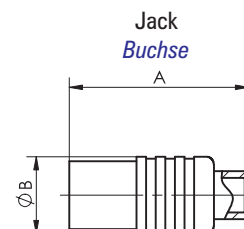

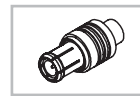

Dimensions Straight Cable Termination (MCX)

Abmessungen gerader Kabelanschluss (MCX)

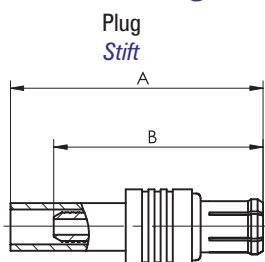

FCT Part Number <i>FCT Teilenummer</i>	A	B	Characteristic Impedance <i>Wellenwiderstand</i>	Suitable Cable <i>Verwendbares Kabel</i>
A25P1NA-201-10	15,7 (0.618)	13,7 (0.540)	50 Ohm	RG316, 188, 174
A25P1NA-205-10	15,7 (0.618)	13,7 (0.540)		RG316, 188, 174 D.S.
A25P1NA-206-10	15,7 (0.618)	13,7 (0.540)		RG178, 196
A25J1NA-201-10	12,6 (0.495)	10,6 (0.417)		RG316, 188, 174
A25J1NA-205-10	12,6 (0.495)	10,6 (0.417)		RG316, 188, 174 D.S.
A25J1NA-206-10	12,6 (0.495)	10,6 (0.417)		RG178, 196
A38P1NA-201-10	15,7 (0.618)	13,7 (0.540)	75 Ohm	RG179, 187
A38P1NA-205-10	15,7 (0.618)	13,7 (0.540)		RG179 D.S., 187
A38J1NA-201-10	12,6 (0.495)	10,6 (0.417)		RG179
A38J1NA-205-10	12,6 (0.495)	10,6 (0.417)		RG179 D.S., 187

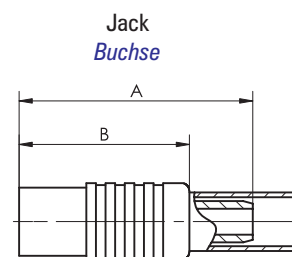

Dimensions Straight Cable Termination, Semi-rigid, Bulkhead (MCX)

Abmessungen gerader Kabelanschluss, semi-rigid, Gehäusedurchführung (MCX)

FCT Part Number <i>FCT Teilenummer</i>	A	B	C	Characteristic Impedance <i>Wellenwiderstand</i>	Suitable Cable <i>Verwendbares Kabel</i>
A25J1BK-103-10	14,3 (0.561)	9,6 (0.378)	6,5 (0.255)	50 Ohm	.086 Semi-Rigid
A25J1BK-104-10	14,3 (0.561)	9,6 (0.378)	6,5 (0.255)		.141 Semi-rigid
A25J1BK-111-10	14,3 (0.561)	9,6 (0.378)	6,5 (0.255)		.047 Semi Rigid
A38J1BK-103-10	14,3 (0.561)	9,6 (0.378)	6,5 (0.255)	75 Ohm	.086 Semi-Rigid
A38J1BK-104-10	14,3 (0.561)	9,6 (0.378)	6,5 (0.255)		.141 Semi-rigid

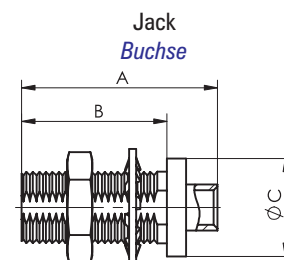

Dimensions Straight Cable Termination, Bulkhead (MCX)

Abmessungen gerader Kabelanschluss, Gehäusedurchführung (MCX)

FCT Part Number <i>FCT Teilenummer</i>	A	B	C	Characteristic Impedance <i>Wellenwiderstand</i>	Suitable Cable <i>Verwendbares Kabel</i>
A25J1BK-201-10	19,2 (0.755)	15,4 (0.606)	8,0 (0.315)	50 Ohm	RG316, 188, 174
A25J1BK-205-10	19,2 (0.755)	15,4 (0.606)	8,0 (0.315)		RG316, 188, 174 D.S.
A25J1BK-206-10	19,2 (0.755)	15,4 (0.606)	8,0 (0.315)		RG178, 196
A38J1BK-201-10	19,2 (0.755)	15,4 (0.606)	8,0 (0.315)	75 Ohm	RG179, 187
A38J1BK-205-10	19,2 (0.755)	15,4 (0.606)	8,0 (0.315)		RG179 D.S., 187

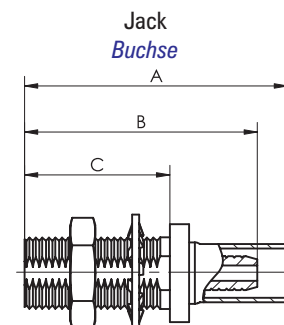

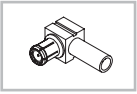

Dimensions Right Angled Cable Termination, Semi-rigid (MCX)

Abmessungen abgewinkelter Kabelanschluss, semi-rigid (MCX)

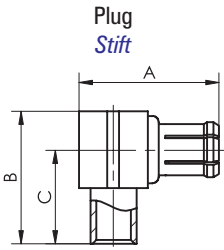

FCT Part Number FCT Teilenummer	A	B	C	Characteristic Impedance Wellenwiderstand	Suitable Cable Verwendbares Kabel
A25P2NA-103-10	8,9 (0.349)	8,8 (0.345)	6,0 (0.236)	50 Ohm	.086 Semi-Rigid
A25P2NA-104-10	8,9 (0.349)	8,8 (0.345)	6,0 (0.236)		.141 Semi-Rigid
A25P2NA-111-10	8,9 (0.349)	8,8 (0.345)	6,0 (0.236)		.047 Semi-Rigid
A38P2NA-103-10	8,9 (0.349)	8,8 (0.345)	6,0 (0.236)	75 Ohm	.086 Semi-Rigid
A38P2NA-104-10	8,9 (0.349)	8,8 (0.345)	6,0 (0.236)		.141 Semi-Rigid

Dimensions Right Angled Cable Termination (MCX)

Abmessungen abgewinkelter Kabelanschluss (MCX)

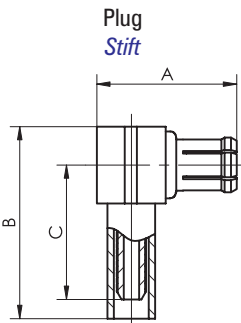

FCT Part Number FCT Teilenummer	A	B	C	Characteristic Impedance Wellenwiderstand	Suitable Cable Verwendbares Kabel
A25P2NA-201-10	8,9 (0.349)	13,2 (0.518)	9,1 (0.359)	50 Ohm	RG316, 188, 174
A25P2NA-205-10	8,9 (0.349)	13,2 (0.518)	9,1 (0.359)		RG316, 188, 174 D.S.
A25P2NA-206-10	8,9 (0.349)	13,2 (0.518)	9,1 (0.359)		RG178, 196
A38P2NA-201-10	8,9 (0.349)	13,2 (0.518)	9,1 (0.359)	75 Ohm	RG179, 187
A38P2NA-205-10	8,9 (0.349)	13,2 (0.518)	9,1 (0.359)		RG179 D.S., 187

Dimensions Straight PCB Termination (MCX)

Abmessungen gerader Leiterplattenanschluss (MCX)

FCT Part Number FCT Teilenummer	A	B	Characteristic impedance Wellenwiderstand	Material Material
A25J1PC-000-10	6,0 (0.236)	3,9 (0.155)	50 Ohm	Brass Messing
A25J1PC-000-11	6,0 (0.236)	1,7 (0.068)		
A38J1PC-000-10	6,0 (0.236)	3,9 (0.155)	75 Ohm	
A38J1PC-000-11	6,0 (0.236)	1,7 (0.068)		

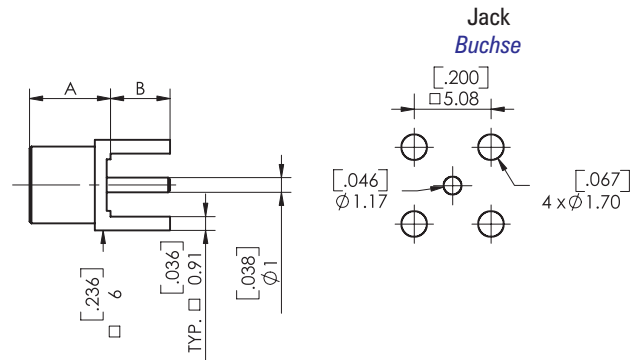

Dimensions Straight PCB Termination, Surface Mounted/SMT (MCX)

Abmessungen gerader Leiterplattenanschluss, Oberflächenmontage/SMT (MCX)

FCT Part Number FCT Teilenummer	Characteristic Impedance Wellenwiderstand	Material Material
A25J1SF-000-10G	50 Ohm	Brass Messing
A38J1SF-000-10G	75 Ohm	

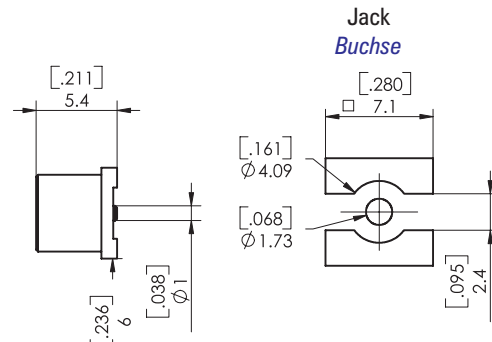

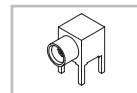

Dimensions Right Angled PCB Termination (MCX)

Abmessungen abgewinkelter Leiterplattenanschluss (MCX)

FCT Part Number <i>FCT Teilenummer</i>	A	B	C	Characteristic Impedance <i>Wellenwiderstand</i>	Material <i>Material</i>
A25J2PC-000-10	9,5 (0.375)	10,0 (0.394)	7,0 (0.276)	50 Ohm	Brass <i>Messing</i>
A38J2PC-000-10	9,5 (0.375)	10,0 (0.394)	7,0 (0.276)	75 Ohm	Brass <i>Messing</i>

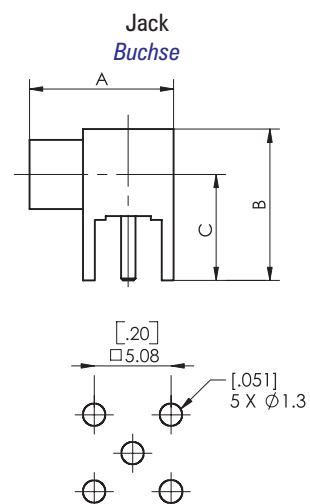

Dimensions Straight Edge Mounted (MCX)

Abmessungen Leiterplatten Kantenmontage, gerade (MCX)

FCT Part Number <i>FCT Teilenummer</i>	A	B	C	Characteristic Impedance <i>Wellenwiderstand</i>	Material <i>Material</i>
A25J1EG-000-10	9,6 (0.376)	6,3 (0.246)	5,0 (0.197)	50 Ohm	Brass <i>Messing</i>
A38J1EG-000-10	9,6 (0.376)	6,3 (0.246)	5,0 (0.197)	75 Ohm	Brass <i>Messing</i>

Jack
Buchse

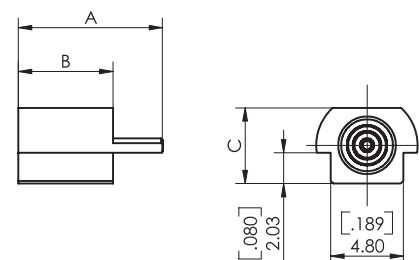

Product Line (MCX)

Lieferübersicht (MCX)

FCT Part Number <i>FCT Teilenummer</i>	Characteristic Impedance <i>Wellenwiderstand</i>	Material <i>Material</i>	Inner Conductor <i>Innenleiter</i>	Suitable Cable <i>Verwendbares Kabel</i>	Mounting <i>Befestigung</i>					
Straight Cable Termination / Gerader Kabelanschluss										
A25P1NA-103-10	50 Ohm	Brass <i>Messing</i>	Plug <i>Stift</i>	0.086 Semi-rigid						
A25P1NA-104-10				0.141 Semi-rigid						
A25P1NA-111-10				0.047 Semi-rigid						
A25P1NA-201-10				RG316, 188, 174	N/A					
A25P1NA-205-10				RG316, 188, 174 D.S.						
A25P1NA-206-10				RG178, 196						
A25J1BK-103-10			75 Ohm	Brass <i>Messing</i>	Jack <i>Buchse</i>	.086 Semi-Rigid	Bulkhead / <i>Gehäusedurchführung</i>			
A25J1BK-104-10						.141 Semi-rigid	Bulkhead / <i>Gehäusedurchführung</i>			
A25J1BK-111-10						.047 Semi Rigid	Bulkhead / <i>Gehäusedurchführung</i>			
A25J1BK-201-10						RG316, 188, 174	Bulkhead / <i>Gehäusedurchführung</i>			
A25J1BK-205-10						RG316, 188, 174 D.S.	Bulkhead / <i>Gehäusedurchführung</i>			
A25J1BK-206-10						RG178, 196	Bulkhead / <i>Gehäusedurchführung</i>			
A25J1NA-103-10					75 Ohm	Brass <i>Messing</i>	Plug <i>Stift</i>	.086 Semi-Rigid		
A25J1NA-104-10								.141 Semi-rigid		
A25J1NA-111-10	.047 Semi Rigid									
A25J1NA-201-10	RG316, 188, 174									
A25J1NA-205-10	RG316, 188, 174 D.S.									
A25J1NA-206-10	RG178, 196									
A38P1NA-103-10	75 Ohm	Brass <i>Messing</i>					Plug <i>Stift</i>	.086 Semi-rigid		
A38P1NA-104-10								0.141 Semi-rigid		
A38P1NA-201-10			RG179, 187							
A38P1NA-205-10			RG179 D.S., 187							
A38J1BK-103-10			.086 Semi-Rigid	Bulkhead / <i>Gehäusedurchführung</i>						
A38J1BK-104-10			.141 Semi-rigid	Bulkhead / <i>Gehäusedurchführung</i>						
A38J1BK-201-10			RG316, 188, 174	Bulkhead / <i>Gehäusedurchführung</i>						
A38J1BK-205-10			RG179 D.S., 187	Bulkhead / <i>Gehäusedurchführung</i>						
A38J1NA-103-10			75 Ohm	Brass <i>Messing</i>	Jack <i>Buchse</i>	.086 Semi-Rigid				
A38J1NA-104-10						.141 Semi-rigid				
A38J1NA-201-10						RG179, 187				
A38J1NA-205-10						RG179 D.S., 187				
Right Angled Cable Termination / Abgewinkelter Kabelanschluss										
A25P2NA-103-10						50 Ohm	Brass <i>Messing</i>	Plug <i>Stift</i>	.086 Semi-Rigid	
A25P2NA-104-10	.141 Semi-Rigid									
A25P2NA-111-10	.047 Semi-Rigid									
A25P2NA-201-10	RG316, 188, 174									
A25P2NA-205-10	RG316, 188, 174 D.S.									
A25P2NA-206-10	RG178, 196									
A38P2NA-103-10	75 Ohm	Brass <i>Messing</i>	Plug <i>Stift</i>	.086 Semi-Rigid						
A38P2NA-104-10				.141 Semi-Rigid						
A38P2NA-201-10				RG179						
A38P2NA-205-10				RG179 D.S.						
Straight PCB Termination / Gerader Leiterplattenanschluss										
A25J1PC-000-10	50 Ohm	Brass <i>Messing</i>	Jack <i>Buchse</i>		PCB Mount / <i>Leiterplatte</i>					
A25J1PC-000-11					PCB Mount / <i>Leiterplatte</i>					
A25J1SF-000-10					Surface Mount / <i>Oberflächenmontage</i>					
A38J1PC-000-10				75 Ohm		PCB Mount / <i>Leiterplatte</i>				
A38J1PC-000-11		PCB Mount / <i>Leiterplatte</i>								
A38J1SF-000-10		Surface Mount / <i>Oberflächenmontage</i>								
Right Angled PCB Termination / Abgewinkelter Leiterplattenanschluss										
A25J2PC-000-10	50 Ohm	Brass <i>Messing</i>	Jack <i>Buchse</i>		PCB Mount / <i>Leiterplatte</i>					
A38J2PC-000-10	75 Ohm	Brass <i>Messing</i>	Jack <i>Buchse</i>		PCB Mount / <i>Leiterplatte</i>					
Straight Edge Mounted / Leiterplatten Kantenmontage, gerade										
A25J1EG-000-10	50 Ohm	Brass <i>Messing</i>	Jack <i>Buchse</i>		Edge mount / <i>Kantenmontage</i>					
A38J1EG-000-10	75 Ohm	Brass <i>Messing</i>	Jack <i>Buchse</i>		Edge mount / <i>Kantenmontage</i>					