

# 1.25MHz, Over-The-Top Micropower, Rail-to-Rail Input and Output Op Amp in SOT-23

## FEATURES

- Operates with Inputs Above  $V^+$
- Rail-to-Rail Input and Output
- Micropower: 300 $\mu$ A Supply Current Max
- Operating Temperature Range:  $-40^{\circ}\text{C}$  to  $125^{\circ}\text{C}$
- Gain Bandwidth Product: 1.25MHz
- Slew Rate: 0.42V/ $\mu$ s
- Low Input Offset Voltage: 800 $\mu$ V Max
- Single Supply Input Range: 0V to 18V
- High Output Current: 18mA Min
- Specified on 3V, 5V and  $\pm 5$ V Supplies
- Output Shutdown on 6-Lead Version
- Reverse-Battery Protection to 18V
- High Voltage Gain: 1500V/mV
- Low Profile (1mm) ThinSOT™ Package

## APPLICATIONS

- Portable Instrumentation
- Battery- or Solar-Powered Systems
- Sensor Conditioning
- Supply Current Sensing
- Battery Monitoring
- MUX Amplifiers
- 4mA to 20mA Transmitters

## DESCRIPTION

The LT<sup>®</sup>1783 is a 1.25MHz op amp available in the small SOT-23 package that operates on all single and split supplies with a total voltage of 2.5V to 18V. The amplifier draws less than 300 $\mu$ A of quiescent current and has reverse-battery protection, drawing negligible current for reverse supply voltages up to 18V.

The input range of the LT1783 includes ground, and a unique feature of this device is its Over-The-Top<sup>®</sup> operation capability with either or both of its inputs above the positive rail. The inputs handle 18V both differential and common mode, independent of supply voltage. The input stage incorporates phase reversal protection to prevent false outputs from occurring even when the inputs are 9V below the negative supply.

The LT1783 can drive loads up to 18mA and still maintain rail-to-rail capability. A shutdown feature on the 6-lead version can disable the part, making the output high impedance and reducing quiescent current to 5 $\mu$ A. The LT1783 op amp is available in the 5- and 6-lead SOT-23 packages. For applications requiring lower power, refer to the LT1782.

LT, LT, LTC, LTM and Over-The-Top are registered trademarks of Linear Technology Corporation. ThinSOT is a trademark of Linear Technology Corporation. All other trademarks are the property of their respective owners.

## TYPICAL APPLICATION

Positive Supply Rail Current Sense

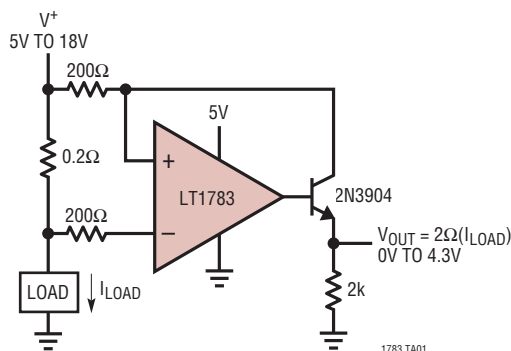

1783 TA01

Distribution of Input Offset Voltage

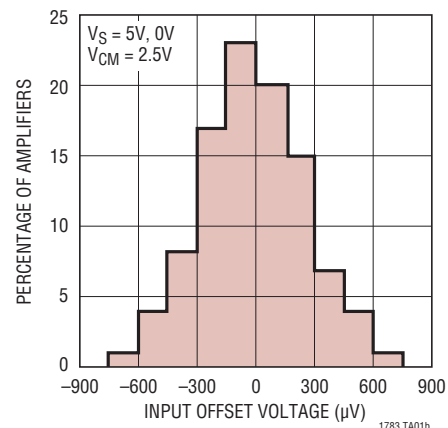

1783 TA01b

1783fb

# LT1783

## ABSOLUTE MAXIMUM RATINGS (Note 1)

Total Supply Voltage ( $V^+$ to $V^-$ ) .....	18V	Specified Temperature Range (Note 4)	
Input Differential Voltage.....	18V	LT1783C .....	-40°C to 85°C
Input Pin Voltage to $V^-$ .....	+24V/-10V	LT1783I .....	-40°C to 85°C
Shutdown Pin Voltage Above $V^-$ .....	18V	LT1783H .....	-40°C to 125°C
Shutdown Pin Current .....	$\pm 10\text{mA}$	Junction Temperature .....	150°C
Output Short-Circuit Duration (Note 2) .....	Indefinite	Storage Temperature Range.....	-65°C to 150°C
Operating Temperature Range (Note 3)		Lead Temperature (Soldering, 10 sec) .....	300°C
LT1783C .....	-40°C to 85°C		
LT1783I .....	-40°C to 85°C		
LT1783H .....	-40°C to 125°C		

## PIN CONFIGURATION

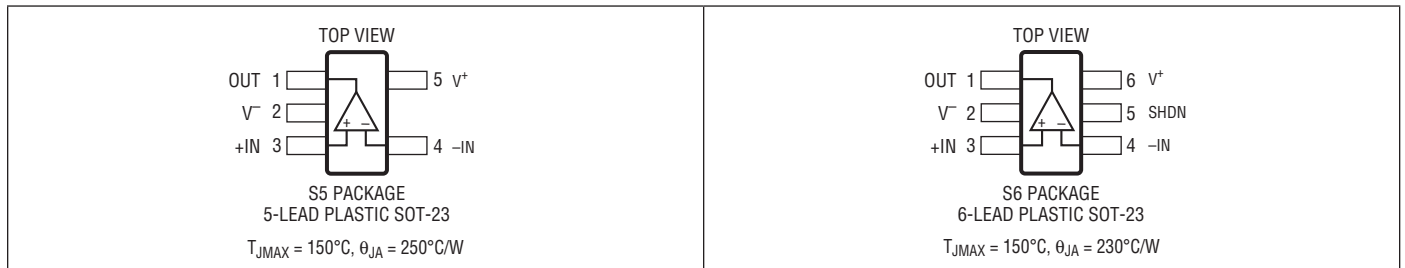

## ORDER INFORMATION

LEAD FREE FINISH	TAPE AND REEL	PART MARKING	PACKAGE DESCRIPTION	TEMPERATURE RANGE
LTC1783CS5#PBF	LTC1783CS5#TRPBF	LTLF	5-Lead Plastic SOT-23	-40°C to 85°C
LTC1783IS5#PBF	LTC1783IS5#TRPBF	LTLG	5-Lead Plastic SOT-23	-40°C to 85°C
LTC1783HS5#PBF	LTC1783HS5#TRPBF	LTXR	5-Lead Plastic SOT-23	-40°C to 125°C
LTC1783CS6#PBF	LTC1783CS6#TRPBF	LTIU	6-Lead Plastic SOT-23	-40°C to 85°C
LTC1783IS6#PBF	LTC1783IS6#TRPBF	LTIV	6-Lead Plastic SOT-23	-40°C to 85°C
LTC1783HS6#PBF	LTC1783HS6#TRPBF	LTXS	6-Lead Plastic SOT-23	-40°C to 125°C
LEAD BASED FINISH	TAPE AND REEL	PART MARKING	PACKAGE DESCRIPTION	TEMPERATURE RANGE
LTC1783CS5	LTC1783CS5#TR	LTLF	5-Lead Plastic SOT-23	-40°C to 85°C
LTC1783IS5	LTC1783IS5#TR	LTLG	5-Lead Plastic SOT-23	-40°C to 85°C
LTC1783HS5	LTC1783HS5#TR	LTXR	5-Lead Plastic SOT-23	-40°C to 125°C
LTC1783CS6	LTC1783CS6#TR	LTIU	6-Lead Plastic SOT-23	-40°C to 85°C
LTC1783IS6	LTC1783IS6#TR	LTIV	6-Lead Plastic SOT-23	-40°C to 85°C
LTC1783HS6	LTC1783HS6#TR	LTXS	6-Lead Plastic SOT-23	-40°C to 125°C

Consult LTC Marketing for parts specified with wider operating temperature ranges.

For more information on lead free part marking, go to: <http://www.linear.com/leadfree/>

For more information on tape and reel specifications, go to: <http://www.linear.com/tapeandreeel/>

**ELECTRICAL CHARACTERISTICS** The ● denotes the specifications which apply over the specified temperature range, otherwise specifications are at  $T_A = 25^\circ\text{C}$ .  $V_S = 3\text{V}, 0\text{V}$ ;  $V_S = 5\text{V}, 0\text{V}$ ;  $V_{CM} = V_{OUT} = \text{half supply}$ , for the 6-lead part  $V_{PIN5} = 0\text{V}$ , pulse power tested unless otherwise specified. (Note 4)

SYMBOL	PARAMETER	CONDITIONS	LT1783C/LT1783I			UNITS
			MIN	TYP	MAX	
V <sub>OS</sub>	Input Offset Voltage	$T_A = 25^\circ\text{C}$ $0^\circ\text{C} \leq T_A \leq 70^\circ\text{C}$ $-40^\circ\text{C} \leq T_A \leq 85^\circ\text{C}$	●	400	800	$\mu\text{V}$
	Input Offset Voltage Drift (Note 9)		●	2	5	$\mu\text{V}/^\circ\text{C}$
I <sub>OS</sub>	Input Offset Current	$V_{CM} = 18\text{V}$ (Note 5)	●	4	8	nA
			●		7	$\mu\text{A}$
I <sub>B</sub>	Input Bias Current	$V_{CM} = 18\text{V}$ (Note 5) SHDN or $V_S = 0\text{V}$ , $V_{CM} = 0\text{V}$ to $18\text{V}$	●	45	80	nA
			●	35	60	$\mu\text{A}$
				0.1		nA
	Input Bias Current Drift		●	0.06		nA/ $^\circ\text{C}$
	Input Noise Voltage	0.1Hz to 10Hz		0.6		$\mu\text{V}_{P-P}$
e <sub>n</sub>	Input Noise Voltage Density	f = 1kHz		20		nV/ $\sqrt{\text{Hz}}$
i <sub>n</sub>	Input Noise Current Density	f = 1kHz		0.14		pA/ $\sqrt{\text{Hz}}$
R <sub>IN</sub>	Input Resistance	Differential	●	0.65	1.3	M $\Omega$
		Common Mode, $V_{CM} = 0\text{V}$ to $(V_{CC} - 1\text{V})$ Common Mode, $V_{CM} = 0\text{V}$ to $18\text{V}$	●	0.3	0.5	G $\Omega$ M $\Omega$
C <sub>IN</sub>	Input Capacitance			5		pF
	Input Voltage Range		●	0	18	V
CMRR	Common Mode Rejection Ratio (Note 5)	$V_{CM} = 0\text{V}$ to $V_{CC} - 1\text{V}$	●	90	100	dB
		$V_{CM} = 0\text{V}$ to $18\text{V}$ (Note 8)	●	68	80	dB
PSRR	Power Supply Rejection Ratio	$V_S = 3\text{V}$ to $12.5\text{V}$ , $V_{CM} = V_O = 1\text{V}$	●	90	100	dB
A <sub>VOL</sub>	Large-Signal Voltage Gain	$V_S = 3\text{V}$ , $V_O = 500\text{mV}$ to $2.5\text{V}$ , $R_L = 10\text{k}$ $V_S = 3\text{V}$ , $0^\circ\text{C} \leq T_A \leq 70^\circ\text{C}$ $V_S = 3\text{V}$ , $-40^\circ\text{C} \leq T_A \leq 85^\circ\text{C}$	●	200	1500	V/mV
			●	133		V/mV
			●	100		V/mV
V <sub>OL</sub>	Output Voltage Swing LOW	$V_S = 5\text{V}$ , $V_O = 500\text{mV}$ to $4.5\text{V}$ , $R_L = 10\text{k}$ $V_S = 5\text{V}$ , $0^\circ\text{C} \leq T_A \leq 70^\circ\text{C}$ $V_S = 5\text{V}$ , $-40^\circ\text{C} \leq T_A \leq 85^\circ\text{C}$	●	400	1500	V/mV
			●	250		V/mV
			●	200		V/mV
V <sub>OH</sub>	Output Voltage Swing HIGH	No Load $I_{SINK} = 5\text{mA}$ $V_S = 5\text{V}$ , $I_{SINK} = 10\text{mA}$	●	3	8	mV
			●	200	400	mV
			●	330	600	mV
I <sub>SC</sub>	Short-Circuit Current (Note 2)	$V_S = 3\text{V}$ , No Load $V_S = 3\text{V}$ , $I_{SOURCE} = 5\text{mA}$	●	2.91	2.94	V
			●	2.6	2.8	V
		$V_S = 5\text{V}$ , No Load $V_S = 5\text{V}$ , $I_{SOURCE} = 10\text{mA}$	●	4.91	4.94	V
			●	4.5	4.74	V
	Minimum Supply Voltage	$V_S = 3\text{V}$ , Short to GND $V_S = 3\text{V}$ , Short to $V_{CC}$		5	10	mA
				15	30	mA
		$V_S = 5\text{V}$ , Short to GND $V_S = 5\text{V}$ , Short to $V_{CC}$		15	30	mA
				20	40	mA
	Reverse Supply Voltage	$I_S = -100\mu\text{A}$	●	2.5	2.7	V
I <sub>S</sub>	Supply Current (Note 6)		●	210	300	$\mu\text{A}$
		$0^\circ\text{C} \leq T_A \leq 70^\circ\text{C}$	●		350	$\mu\text{A}$
		$-40^\circ\text{C} \leq T_A \leq 85^\circ\text{C}$	●		375	$\mu\text{A}$
	Supply Current, SHDN	$V_{PIN5} = 2\text{V}$ , No Load (Note 10)	●	5	18	$\mu\text{A}$
I <sub>SHDN</sub>	Shutdown Pin Current	$V_{PIN5} = 0.3\text{V}$ , No Load (Note 10)	●	0.5		nA
		$V_{PIN5} = 2\text{V}$ , No Load (Note 10)	●	2	8	$\mu\text{A}$
		$V_{PIN5} = 5\text{V}$ , No Load (Note 10)		5		$\mu\text{A}$
	Shutdown Output Leakage Current	$V_{PIN5} = 2\text{V}$ , No Load (Note 10)	●	0.05	1	$\mu\text{A}$
	Maximum Shutdown Pin Current	$V_{PIN5} = 18\text{V}$ , No Load (Note 10)	●	10	30	$\mu\text{A}$

## ELECTRICAL CHARACTERISTICS

The ● denotes the specifications which apply over the specified temperature range, otherwise specifications are at  $T_A = 25^\circ\text{C}$ .  $V_S = 3\text{V}, 0\text{V}$ ;  $V_S = 5\text{V}, 0\text{V}$ ;  $V_{\text{CM}} = V_{\text{OUT}} = \text{half supply}$ , for the 6-lead part  $V_{\text{PIN5}} = 0\text{V}$ , pulse power tested unless otherwise specified. (Note 4)

SYMBOL	PARAMETER	CONDITIONS	LT1783C/LT1783I			UNITS
			MIN	TYP	MAX	
$V_L$	Shutdown Pin Input Low Voltage	(Note 10)	●		0.3	V
$V_H$	Shutdown Pin Input High Voltage	(Note 10)	●	2		V
$t_{\text{ON}}$	Turn-On Time	$V_{\text{PIN5}} = 5\text{V to } 0\text{V}, R_L = 10\text{k}$ (Note 10)		25		$\mu\text{s}$
$t_{\text{OFF}}$	Turn-Off Time	$V_{\text{PIN5}} = 0\text{V to } 5\text{V}, R_L = 10\text{k}$ (Note 10)		3		$\mu\text{s}$
GBW	Gain Bandwidth Product (Note 5)	$f = 5\text{kHz}$ $0^\circ\text{C} \leq T_A \leq 70^\circ\text{C}$ $-40^\circ\text{C} \leq T_A \leq 85^\circ\text{C}$	● ●	750 600 550	1250	kHz kHz kHz
SR	Slew Rate (Note 7)	$A_V = -1, R_L = \infty$ $0^\circ\text{C} \leq T_A \leq 70^\circ\text{C}$ $-40^\circ\text{C} \leq T_A \leq 85^\circ\text{C}$	● ●	0.24 0.21 0.19	0.42	V/ $\mu\text{s}$ V/ $\mu\text{s}$ V/ $\mu\text{s}$
FPBW	Full-Power Bandwidth (Note 11)	$V_{\text{OUT}} = 2V_{\text{P-P}}$		66		kHz
$t_S$	Settling Time	$V_S = 5\text{V}, \Delta V_{\text{OUT}} = 2\text{V to } 0.1\%, A_V = -1$		12		$\mu\text{s}$
THD	Distortion	$V_S = 3\text{V}, V_0 = 2V_{\text{P-P}}, A_V = 1, R_L = 10\text{k}, f = 1\text{kHz}$		0.001		%

The ● denotes the specifications which apply over the specified temperature range, otherwise specifications are at  $T_A = 25^\circ\text{C}$ .  $V_S = \pm 5\text{V}, V_{\text{CM}} = 0\text{V}, V_{\text{OUT}} = 0\text{V}$ , for the 6-lead part  $V_{\text{PIN5}} = V^-$ , pulse power tested unless otherwise specified. (Note 4)

SYMBOL	PARAMETER	CONDITIONS	LT1783C/LT1783I			UNITS
			MIN	TYP	MAX	
$V_{\text{OS}}$	Input Offset Voltage	$T_A = 25^\circ\text{C}$ $0^\circ\text{C} \leq T_A \leq 70^\circ\text{C}$ $-40^\circ\text{C} \leq T_A \leq 85^\circ\text{C}$	● ●	500	900 1050 1200	$\mu\text{V}$ $\mu\text{V}$ $\mu\text{V}$
	Input Offset Voltage Drift (Note 9)		●	2	5	$\mu\text{V}/^\circ\text{C}$
$I_{\text{OS}}$	Input Offset Current		●	4	8	nA
$I_B$	Input Bias Current		●	40	80	nA
	Input Bias Current Drift		●	0.06		nA/ $^\circ\text{C}$
	Input Noise Voltage	0.1Hz to 10Hz		1		$\mu\text{V}_{\text{P-P}}$
$e_n$	Input Noise Voltage Density	$f = 1\text{kHz}$		20		nV/ $\sqrt{\text{Hz}}$
$i_n$	Input Noise Current Density	$f = 1\text{kHz}$		0.14		pA/ $\sqrt{\text{Hz}}$
$R_{\text{IN}}$	Input Resistance	Differential Common Mode, $V_{\text{CM}} = -5\text{V to } 13\text{V}$	● ●	0.65 0.3	1.3 0.5	M $\Omega$ M $\Omega$
$C_{\text{IN}}$	Input Capacitance			5		pF
	Input Voltage Range		●	-5	13	V
CMRR	Common Mode Rejection Ratio	$V_{\text{CM}} = -5\text{V to } 13\text{V}$	●	68	80	dB
$A_{\text{VOL}}$	Large-Signal Voltage Gain	$V_0 = \pm 4\text{V}, R_L = 10\text{k}$ $0^\circ\text{C} \leq T_A \leq 70^\circ\text{C}$ $-40^\circ\text{C} \leq T_A \leq 85^\circ\text{C}$	● ●	70 50 40	160	V/mV V/mV V/mV
$V_{\text{OL}}$	Output Voltage Swing LOW	No Load $I_{\text{SINK}} = 5\text{mA}$ $I_{\text{SINK}} = 10\text{mA}$	● ● ●	-4.997 -4.8 -4.67	-4.992 -4.6 -4.4	V V V
$V_{\text{OH}}$	Output Voltage Swing HIGH	No Load $I_{\text{SOURCE}} = 5\text{mA}$ $I_{\text{SOURCE}} = 10\text{mA}$	● ● ●	4.91 4.6 4.5	4.94 4.8 4.74	V V V
$I_{\text{SC}}$	Short-Circuit Current (Note 2)	Short to GND $0^\circ\text{C} \leq T_A \leq 70^\circ\text{C}$	●	18 15	30	mA mA
PSRR	Power Supply Rejection Ratio	$V_S = \pm 1.5\text{V to } \pm 9\text{V}$	●	90	100	dB

**ELECTRICAL CHARACTERISTICS** The ● denotes the specifications which apply over the specified temperature range, otherwise specifications are at  $T_A = 25^\circ\text{C}$ .  $V_S = \pm 5\text{V}$ ,  $V_{CM} = 0\text{V}$ ,  $V_{OUT} = 0\text{V}$ , for the 6-lead part  $V_{PIN5} = V^-$ , pulse power tested unless otherwise specified. (Note 4)

SYMBOL	PARAMETER	CONDITIONS	LT1783C/LT1783I			UNITS
			MIN	TYP	MAX	
$I_S$	Supply Current	$0^\circ\text{C} \leq T_A \leq 70^\circ\text{C}$	●	230	325	$\mu\text{A}$
		$-40^\circ\text{C} \leq T_A \leq 85^\circ\text{C}$	●		375 400	$\mu\text{A}$ $\mu\text{A}$
	Supply Current, SHDN	$V_{PIN5} = -3\text{V}$ , $V_S = \pm 5\text{V}$ , No Load (Note 10)	●	6	20	$\mu\text{A}$
$I_{SHDN}$	Shutdown Pin Current	$V_{PIN5} = -4.7\text{V}$ , $V_S = \pm 5\text{V}$ , No Load (Note 10)	●	0.5		nA
		$V_{PIN5} = -3\text{V}$ , $V_S = \pm 5\text{V}$ , No Load (Note 10)		2	8	$\mu\text{A}$
	Maximum Shutdown Pin Current	$V_{PIN5} = 9\text{V}$ , $V_S = \pm 9\text{V}$ (Note 10)	●	10	30	$\mu\text{A}$
	Shutdown Output Leakage Current	$V_{PIN5} = -7\text{V}$ , $V_S = \pm 9\text{V}$ , No Load (Note 10)	●	0.05	1	$\mu\text{A}$
$V_L$	Shutdown Pin Input Low Voltage	$V_S = \pm 5\text{V}$ (Note 10)	●		-4.7	V
$V_H$	Shutdown Pin Input High Voltage	$V_S = \pm 5\text{V}$ (Note 10)	●	-2.8		V
$t_{ON}$	Turn-On Time	$V_{PIN5} = 0\text{V}$ to $-5\text{V}$ , $R_L = 10\text{k}$ (Note 10)	●	25		$\mu\text{s}$
$t_{OFF}$	Turn-Off Time	$V_{PIN5} = -5\text{V}$ to $0\text{V}$ , $R_L = 10\text{k}$ (Note 10)	●	3		$\mu\text{s}$
GBW	Gain Bandwidth Product	$f = 5\text{kHz}$	●	800	1300	kHz
		$0^\circ\text{C} \leq T_A \leq 70^\circ\text{C}$	●	700		kHz
		$-40^\circ\text{C} \leq T_A \leq 85^\circ\text{C}$	●	625		kHz
SR	Slew Rate	$A_V = -1$ , $R_L = \infty$ , $V_O = \pm 4\text{V}$ , Measured at $V_O = \pm 2\text{V}$	●	0.26	0.45	V/ $\mu\text{s}$
		$0^\circ\text{C} \leq T_A \leq 70^\circ\text{C}$	●	0.23		V/ $\mu\text{s}$
		$-40^\circ\text{C} \leq T_A \leq 85^\circ\text{C}$	●	0.21		V/ $\mu\text{s}$
FPBW	Full-Power Bandwidth (Note 11)	$V_{OUT} = 8V_{P-P}$		18		kHz
$t_S$	Settling Time	$\Delta V_{OUT} = 4\text{V}$ to 0.1%, $A_V = 1$		10		$\mu\text{s}$

The ● denotes the specifications which apply over the full operating temperature range of  $-40^\circ\text{C} \leq T_A \leq 125^\circ\text{C}$ .  $V_S = 3\text{V}$ ,  $0\text{V}$ ;  $V_S = 5\text{V}$ ,  $0\text{V}$ ;  $V_{CM} = V_{OUT} = \text{half supply}$ , for the 6-lead part  $V_{PIN5} = 0\text{V}$ , pulse power tested unless otherwise specified. (Note 4)

SYMBOL	PARAMETER	CONDITIONS	LT1783H			UNITS
			MIN	TYP	MAX	
$V_{OS}$	Input Offset Voltage		●	400	850	$\mu\text{V}$
			●		3	mV
	Input Offset Voltage Drift (Note 9)		●		15	$\mu\text{V}/^\circ\text{C}$
$I_{OS}$	Input Offset Current	$V_{CM} = 18\text{V}$ (Note 5)	●		15	nA
			●		10	$\mu\text{A}$
$I_B$	Input Bias Current	$V_{CM} = 18\text{V}$ (Note 5)	●		150	nA
			●		150	$\mu\text{A}$
	Input Voltage Range		●	0.3	18	V
CMRR	Common Mode Rejection Ratio	$V_{CM} = 0.3\text{V}$ to $V_{CC} - 1\text{V}$	●	76		dB
		$V_{CM} = 0.3\text{V}$ to $18\text{V}$	●	60		dB
$A_{VOL}$	Large-Signal Voltage Gain	$V_S = 3\text{V}$ , $V_O = 500\text{mV}$ to $2.5\text{V}$ , $R_L = 10\text{k}$	●	200	1500	V/mV
				50		V/mV
		$V_S = 5\text{V}$ , $V_O = 500\text{mV}$ to $4.5\text{V}$ , $R_L = 10\text{k}$	●	400	1500	V/mV
			●	100		V/mV
$V_{OL}$	Output Voltage Swing LOW	No Load	●		15	mV
		$I_{SINK} = 5\text{mA}$	●		800	mV
		$V_S = 5\text{V}$ , $I_{SINK} = 10\text{mA}$	●		1200	mV
$V_{OH}$	Output Voltage Swing HIGH	$V_S = 3\text{V}$ , No Load	●	2.85		V
		$V_S = 3\text{V}$ , $I_{SOURCE} = 5\text{mA}$	●	2.30		V
		$V_S = 5\text{V}$ , No Load	●	4.85		V
		$V_S = 5\text{V}$ , $I_{SOURCE} = 10\text{mA}$	●	4		V
PSRR	Power Supply Rejection Ratio	$V_S = 3\text{V}$ to $12.5\text{V}$ , $V_{CM} = V_O = 1\text{V}$	●	80		dB

## ELECTRICAL CHARACTERISTICS

The ● denotes the specifications which apply over the full operating temperature range of  $-40^{\circ}\text{C} \leq T_A \leq 125^{\circ}\text{C}$ .  $V_S = 3\text{V}, 0\text{V}$ ;  $V_S = 5\text{V}, 0\text{V}$ ;  $V_{\text{CM}} = V_{\text{OUT}} = \text{half supply}$ , for the 6-lead part  $V_{\text{PIN5}} = 0\text{V}$ , pulse power tested unless otherwise specified. (Note 4)

SYMBOL	PARAMETER	CONDITIONS	LT1783H			UNITS
			MIN	TYP	MAX	
	Minimum Supply Voltage		● 2.7			V
	Reverse Supply Voltage		● 18			V
$I_S$	Supply Current		●	210	300 600	$\mu\text{A}$ $\mu\text{A}$
	Supply Current, SHDN	$V_{\text{PIN5}} = 2\text{V}$ , No Load (Note 10)	●		25	$\mu\text{A}$
$I_{\text{SHDN}}$	Shutdown Pin Current	$V_{\text{PIN5}} = 0.3\text{V}$ , No Load (Note 10) $V_{\text{PIN5}} = 2\text{V}$ , No Load (Note 10)	● ●	0.5	12	nA $\mu\text{A}$
	Output Leakage Current	$V_{\text{PIN5}} = 2\text{V}$ , No Load (Note 10)	●		2.5	$\mu\text{A}$
	Maximum Shutdown Pin Current	$V_{\text{PIN5}} = 18\text{V}$ , No Load (Note 10)	●		40	$\mu\text{A}$
GBW	Gain Bandwidth Product	$f = 5\text{kHz}$ (Note 5)	●	750 400	1250	kHz kHz
	Slew Rate	$A_V = -1$ , $R_L = \infty$ (Note 7)	●	0.24 0.12	0.42	V/ $\mu\text{s}$ V/ $\mu\text{s}$

The ● denotes the specifications which apply over the full operating temperature range of  $-40^{\circ}\text{C} \leq T_A \leq 125^{\circ}\text{C}$ .  $V_S = \pm 5\text{V}$ ,  $V_{\text{CM}} = 0\text{V}$ ,  $V_{\text{OUT}} = 0\text{V}$ ,  $V_{\text{SHDN}} = V^-$ ,  $T_A = -40^{\circ}\text{C}$  to  $125^{\circ}\text{C}$ , for the 6-lead part  $V_{\text{PIN5}} = V^-$ , pulse power tested unless otherwise specified. (Note 4)

SYMBOL	PARAMETER	CONDITIONS	LT1783H			UNITS
			MIN	TYP	MAX	
$V_{\text{OS}}$	Input Offset Voltage		●	500	950 3.1	$\mu\text{V}$ mV
	Input Offset Voltage Drift (Note 9)		●		15	$\mu\text{V}/^{\circ}\text{C}$
$I_{\text{OS}}$	Input Offset Current		●		15	nA
$I_B$	Input Bias Current		●		150	nA
CMRR	Common Mode Rejection Ratio	$V_{\text{CM}} = -4.7\text{V}$ to $13\text{V}$	●	60		dB
$A_{\text{VOL}}$	Large-Signal Voltage Gain	$V_O = \pm 4\text{V}$ , $R_L = 10\text{k}$	●	70 10	160	V/mV V/mV
	Output Voltage Swing	No Load $I_{\text{OUT}} = \pm 5\text{mA}$ $I_{\text{OUT}} = \pm 10\text{mA}$	● ● ●	$\pm 4.85$ $\pm 4.20$ $\pm 3.80$		V V V
PSRR	Power Supply Rejection Ratio	$V_S = \pm 1.5\text{V}$ to $\pm 9\text{V}$	●	80		dB
	Minimum Supply Voltage		●	$\pm 1.35$		V
$I_S$	Supply Current		●	230	325 650	$\mu\text{A}$ $\mu\text{A}$
	Supply Current, SHDN	$V_{\text{PIN5}} = -3\text{V}$ , $V_S = \pm 5\text{V}$ , No Load (Note 10)	●		25	$\mu\text{A}$
$I_{\text{SHDN}}$	Shutdown Pin Current	$V_{\text{PIN5}} = -4.7\text{V}$ , $V_S = \pm 5\text{V}$ , No Load (Note 10) $V_{\text{PIN5}} = -3\text{V}$ , $V_S = \pm 5\text{V}$ , No Load (Note 10)	● ●	0.5	12	nA $\mu\text{A}$
	Maximum Shutdown Pin Current	$V_{\text{PIN5}} = 9\text{V}$ , $V_S = \pm 9\text{V}$ (Note 10)	●		45	$\mu\text{A}$
	Output Leakage Current	$V_{\text{PIN5}} = -7\text{V}$ , $V_S = \pm 9\text{V}$ , No Load	●		3	$\mu\text{A}$
$V_L$	Shutdown Pin Input Low Voltage	$V_S = \pm 5\text{V}$	●		-4.7	V
$V_H$	Shutdown Pin Input High Voltage	$V_S = \pm 5\text{V}$	●	-2.8		V
GBW	Gain Bandwidth Product	$f = 5\text{kHz}$	●	800 425	1300	kHz kHz
	Slew Rate	$A_V = -1$ , $R_L = \infty$ , $V_O = 4\text{V}$ Measured at $V_O = \pm 2\text{V}$	●	0.26 0.14	0.45	V/ $\mu\text{s}$ V/ $\mu\text{s}$

## ELECTRICAL CHARACTERISTICS

**Note 1:** Stresses beyond those listed under Absolute Maximum Ratings may cause permanent damage to the device. Exposure to any Absolute Maximum Rating condition for extended periods may affect device reliability and lifetime.

**Note 2:** A heat sink may be required to keep the junction temperature below absolute maximum.

**Note 3:** The LT1783C and LT1873I are guaranteed functional over the operating temperature range of  $-40^{\circ}\text{C}$  to  $85^{\circ}\text{C}$ . The LT1783H is guaranteed functional over the operating temperature range of  $-40^{\circ}\text{C}$  to  $125^{\circ}\text{C}$ .

**Note 4:** The LT1783C is guaranteed to meet specified performance from  $0^{\circ}\text{C}$  to  $70^{\circ}\text{C}$ . The LT1783C is designed, characterized and expected to meet specified performance from  $-40^{\circ}\text{C}$  to  $85^{\circ}\text{C}$  but is not tested or QA sampled at these temperatures. The LT1783I is guaranteed to meet specified performance from  $-40^{\circ}\text{C}$  to  $85^{\circ}\text{C}$ . The LT1783H is guaranteed to meet specified performance from  $-40^{\circ}\text{C}$  to  $125^{\circ}\text{C}$ .

**Note 5:**  $V_S = 5\text{V}$  limits are guaranteed by correlation to  $V_S = 3\text{V}$  and  $V_S = \pm 5\text{V}$  or  $V_S = \pm 9\text{V}$  tests.

**Note 6:**  $V_S = 3\text{V}$  limits are guaranteed by correlation to  $V_S = 5\text{V}$  and  $V_S = \pm 5\text{V}$  or  $V_S = \pm 9\text{V}$  tests.

**Note 7:** Guaranteed by correlation to slew rate at  $V_S = \pm 5\text{V}$ , and GBW at  $V_S = 3\text{V}$  and  $V_S = \pm 5\text{V}$  tests.

**Note 8:** This specification implies a typical input offset voltage of  $1.8\text{mV}$  at  $V_{CM} = 18\text{V}$  and a maximum input offset voltage of  $7.2\text{mV}$  at  $V_{CM} = 18\text{V}$ .

**Note 9:** This parameter is not 100% tested.

**Note 10:** Specifications apply to 6-lead SOT-23 with shutdown.

**Note 11:** Full-power bandwidth is calculated from the slew rate:

$$\text{FPBW} = \text{SR}/2\pi V_P.$$

## TYPICAL PERFORMANCE CHARACTERISTICS

Supply Current vs Supply Voltage

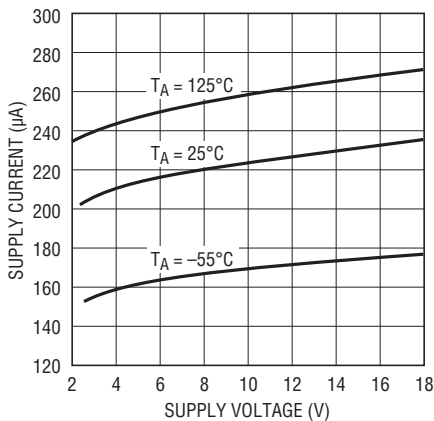

1783 G01

Minimum Supply Voltage

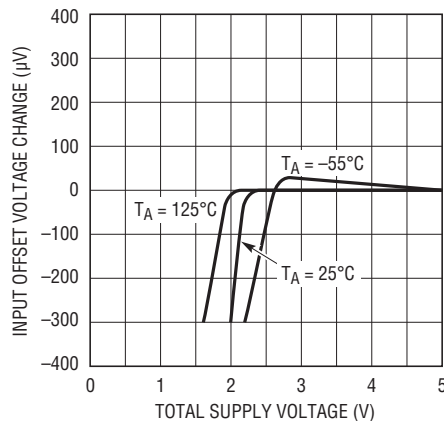

1783 G02

Output Voltage vs Large Input Voltage

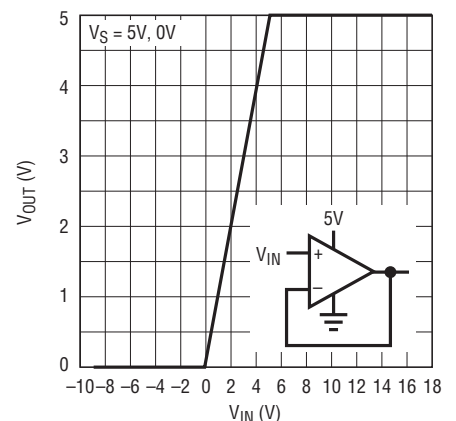

1783 G02a

Input Bias Current vs Common Mode Voltage

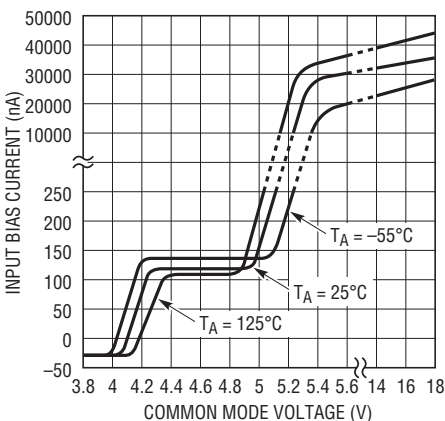

1783 G03

Output Saturation Voltage vs Load Current (Output High)

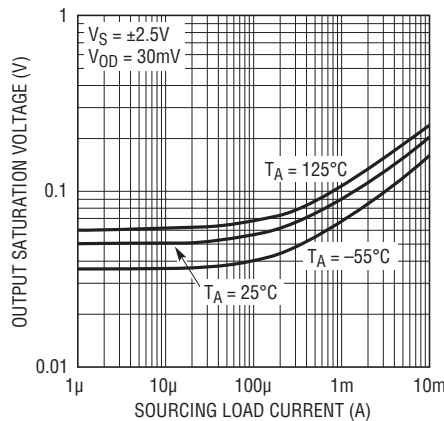

1783 G04

Output Saturation Voltage vs Load Current (Output Low)

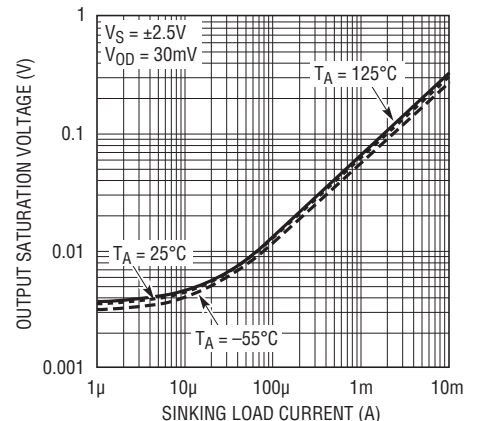

1783 G05

1783fb

TYPICAL PERFORMANCE CHARACTERISTICS

Output Saturation Voltage vs Input Overdrive

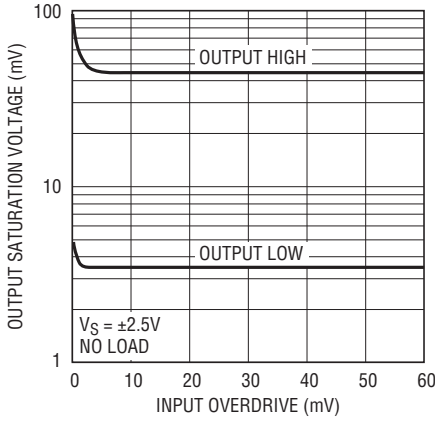

1783 G06

Output Short-Circuit Current vs Temperature

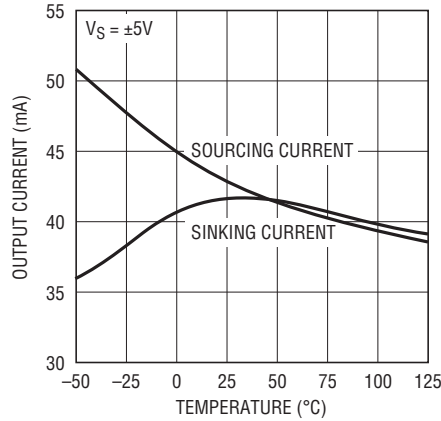

1783 G06a

0.1Hz to 10Hz Noise Voltage

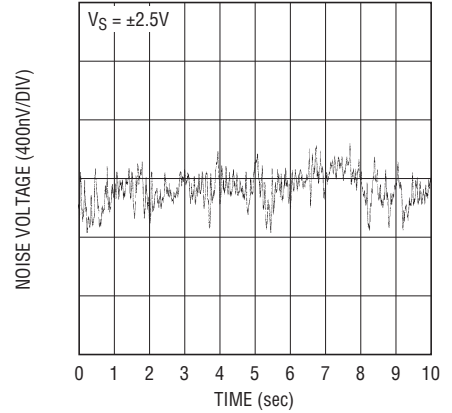

1783 G07

Noise Voltage Density vs Frequency

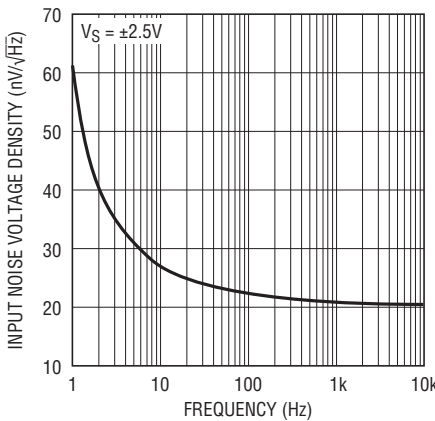

1783 G08

Input Noise Current vs Frequency

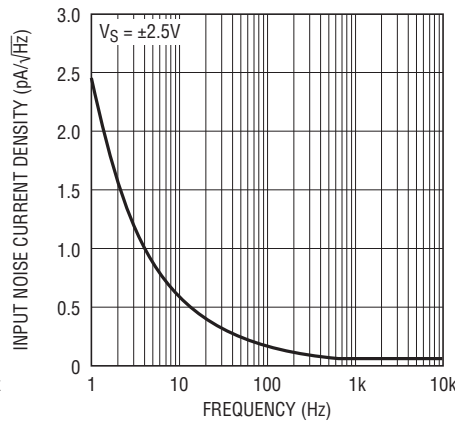

1783 G09

Gain and Phase Shift vs Frequency

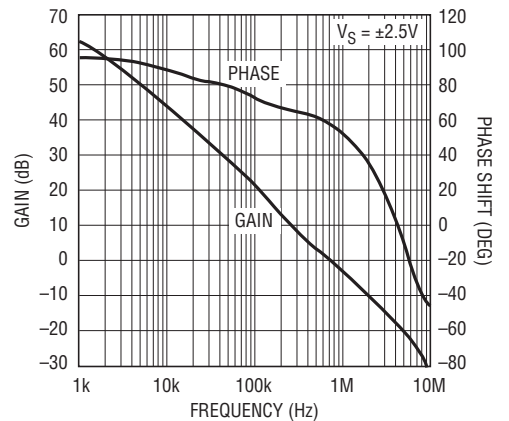

1783 G10

Gain Bandwidth Product vs Temperature

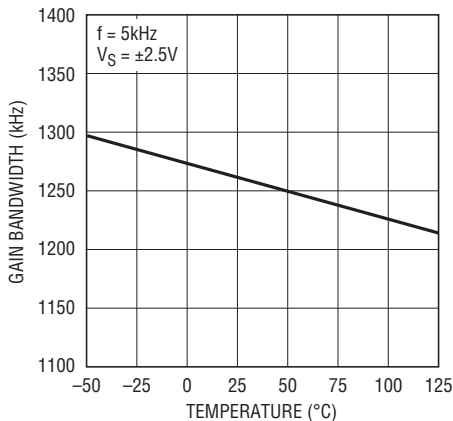

1783 G11

Slew Rate vs Temperature

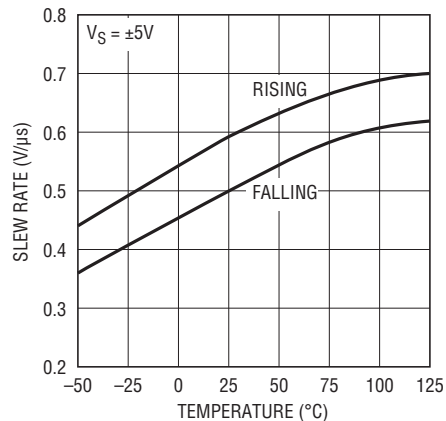

1783 G12



# TYPICAL PERFORMANCE CHARACTERISTICS

**Gain Bandwidth Product and Phase Margin vs Supply Voltage**

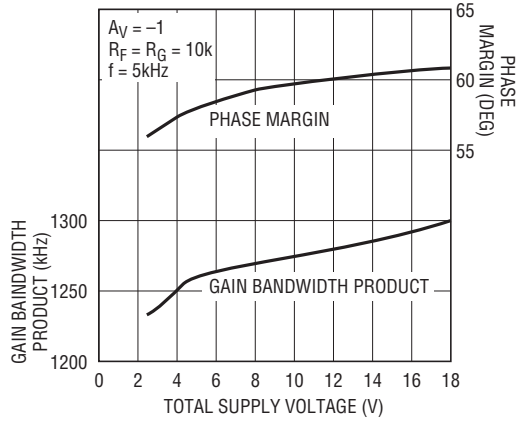

**Gain Bandwidth and Phase Margin vs Load Resistance**

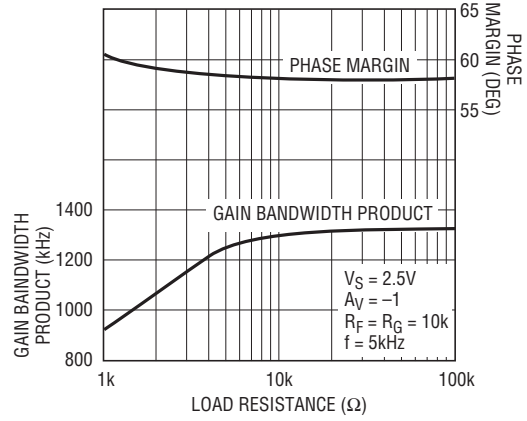

**PSRR vs Frequency**

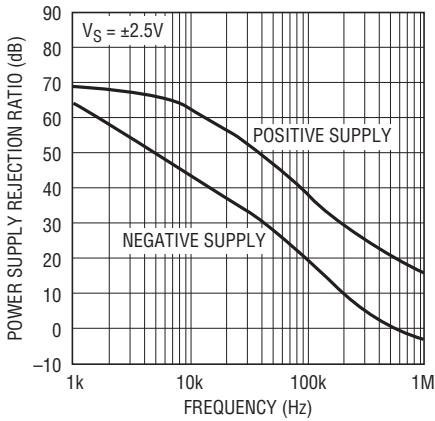

**CMRR vs Frequency**

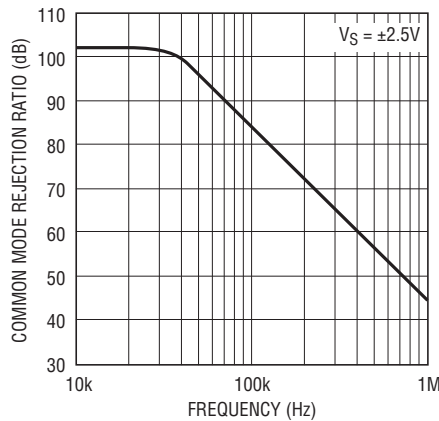

**Output Impedance vs Frequency**

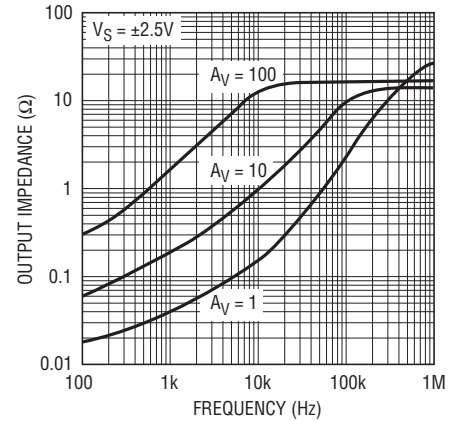

**Disabled Output Impedance vs Frequency (Note 8)**

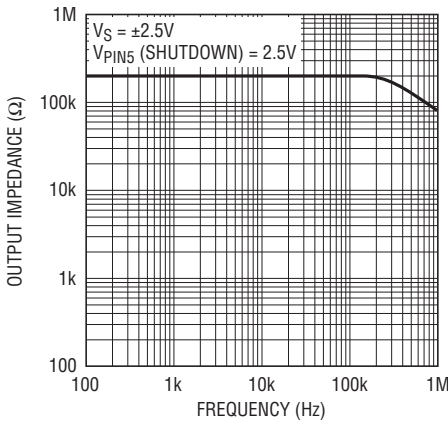

**Settling Time to 0.1% vs Output Step**

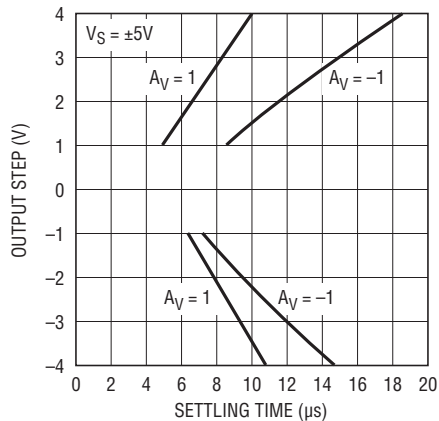

**Capacitive Load Handling Overshoot vs Capacitive Load**

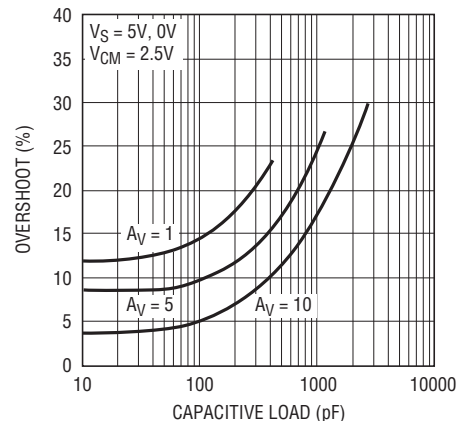

TYPICAL PERFORMANCE CHARACTERISTICS

Undistorted Output Swing vs Frequency

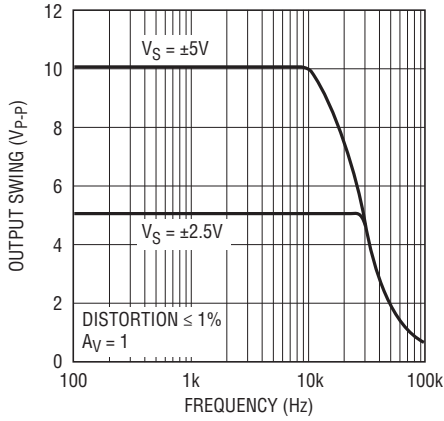

1783 G20

Total Harmonic Distortion + Noise vs Frequency

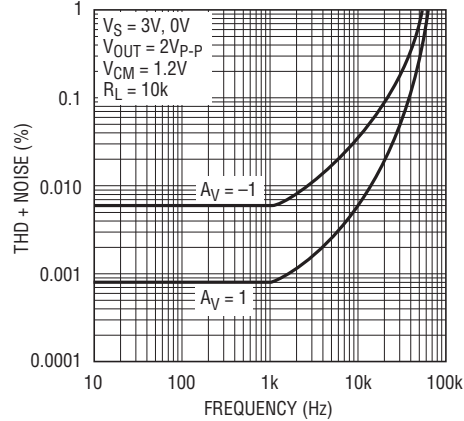

1783 G21

Total Harmonic Distortion + Noise vs Load Resistance

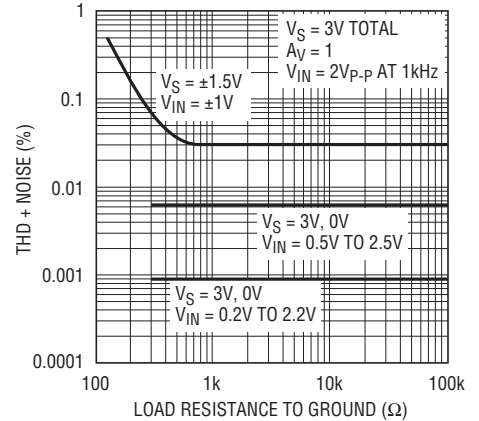

1783 G22

Total Harmonic Distortion + Noise vs Output Voltage Amplitude

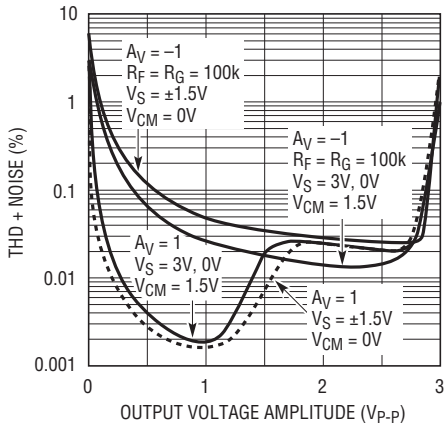

1783 G23

Open-Loop Gain

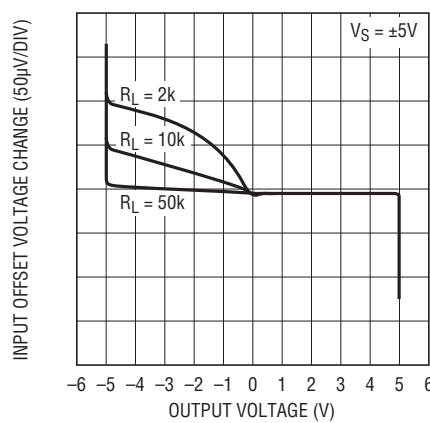

1783 G24

Supply Current vs SHDN Pin Voltage

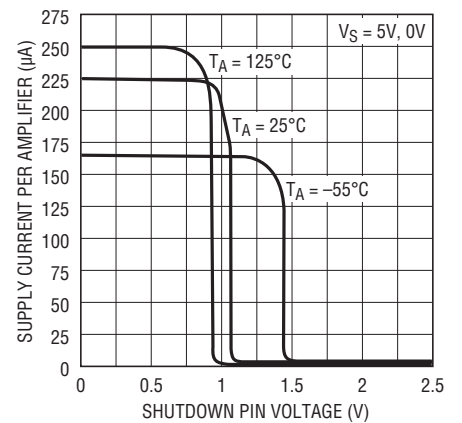

1783 G25

Large-Signal Response

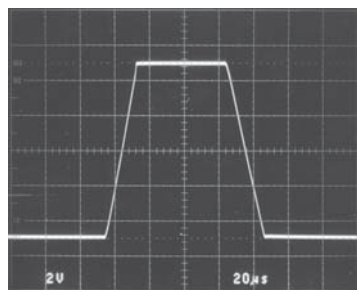

1783 G26

VS = ±5V  
AV = 1  
CL = 15pF

Small-Signal Response

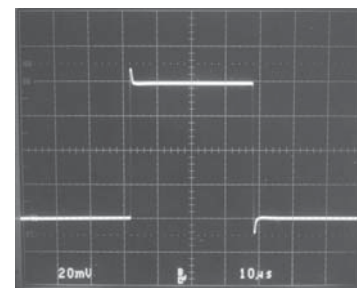

1783 G27

VS = ±5V  
AV = 1  
CL = 15pF

## APPLICATIONS INFORMATION

### Supply Voltage

The positive supply pin of the LT1783 should be bypassed with a small capacitor (typically 0.1 $\mu$ F) within an inch of the pin. When driving heavy loads, an additional 4.7 $\mu$ F electrolytic capacitor should be used. When using split supplies, the same is true for the negative supply pin.

The LT1783 is protected against reverse-battery voltages up to 18V. In the event a reverse-battery condition occurs, the supply current is less than 1nA.

### Inputs

The LT1783 has two input stages, NPN and PNP (see the Simplified Schematic), resulting in three distinct operating regions as shown in the Input Bias Current vs Common Mode typical performance curve.

For input voltages about 0.8V or more below  $V^+$ , the PNP input stage is active and the input bias current is typically  $-40$ nA. When the input common mode voltage is within 0.5V of the positive rail, the NPN stage is operating and the input bias current is typically 80nA. Increases in temperature will cause the voltage at which operation switches from the PNP input stage to the NPN input stage to move towards  $V^+$ . The input offset voltage of the NPN stage is untrimmed and is typically 1.8mV.

A Schottky diode in the collector of the input transistors, along with special geometries for these NPN transistors, allow the LT1783 to operate with either or both of its inputs above  $V^+$ . At about 0.3V above  $V^+$ , the NPN input transistor is fully saturated and the input bias current is typically 30 $\mu$ A at room temperature. The input offset voltage is typically 1.8mV when operating above  $V^+$ . The LT1783 will operate with its inputs 18V above  $V^-$  regardless of  $V^+$ .

The inputs are protected against excursions as much as 10V below  $V^-$  by an internal 1k resistor in series with each input and a diode from the input to the negative supply. The input stage of the LT1783 incorporates phase reversal protection to prevent the output from phase reversing for inputs up to 9V below  $V^-$ . There are no clamping diodes between the inputs and the maximum differential input voltage is 18V.

### Output

The output of the LT1783 can swing to within 60mV of the positive rail with no load and within 3mV of the negative rail with no load. When monitoring input voltages within 60mV of the positive rail or within 3mV of the negative rail, gain should be taken to keep the output from clipping. The LT1783 can sink and source over 30mA at  $\pm 5$ V supplies, sourcing current is reduced to 10mA at 3V total supplies as noted in the Electrical Characteristics.

The LT1783 is internally compensated to drive at least 400pF of capacitance under any output loading conditions. A 0.22 $\mu$ F capacitor in series with a 150 $\Omega$  resistor between the output and ground will compensate these amplifiers for larger capacitive loads, up to 10,000pF, at all output currents.

### Distortion

There are two main contributors to distortion in op amps: output crossover distortion as the output transitions from sourcing to sinking current, and distortion caused by non-linear common mode rejection. If the op amp is operating inverting, there is no common mode induced distortion. If the op amp is operating in the PNP input stage (input is not within 0.8V of  $V^+$ ), the CMRR is very good, typically

100dB. When the LT1783 switches between input stages, there is significant nonlinearity in the CMRR. Lower load resistance increases the output crossover distortion but has no effect on the input stage transition distortion. For lowest distortion, the LT1783 should be operated single supply, with the output always sourcing current and with the input voltage swing between ground and ( $V^+ - 0.8V$ ). See the Typical Performance Characteristics curves, "Total Harmonic Distortion + Noise vs Output Voltage Amplitude."

## Gain

The open-loop gain is almost independent of load when the output is sourcing current. This optimizes performance

in single supply applications where the load is returned to ground. The typical performance curve of open-loop gain for various loads shows the details.

## Shutdown

The 6-lead part includes a shutdown feature that disables the part, reducing quiescent current and making the output high impedance. The part can be shut down by bringing the SHDN pin 1.2V or more above  $V^-$ . When shut down, the supply current is about  $5\mu A$  and the output leakage current is less than  $1\mu A$  ( $V^- \leq V_{OUT} \leq V^+$ ). In normal operation, the SHDN pin can be tied to  $V^-$  or left floating. See the Typical Performance Characteristics curves, "Supply Current vs Shutdown Voltage."

## SIMPLIFIED SCHEMATIC

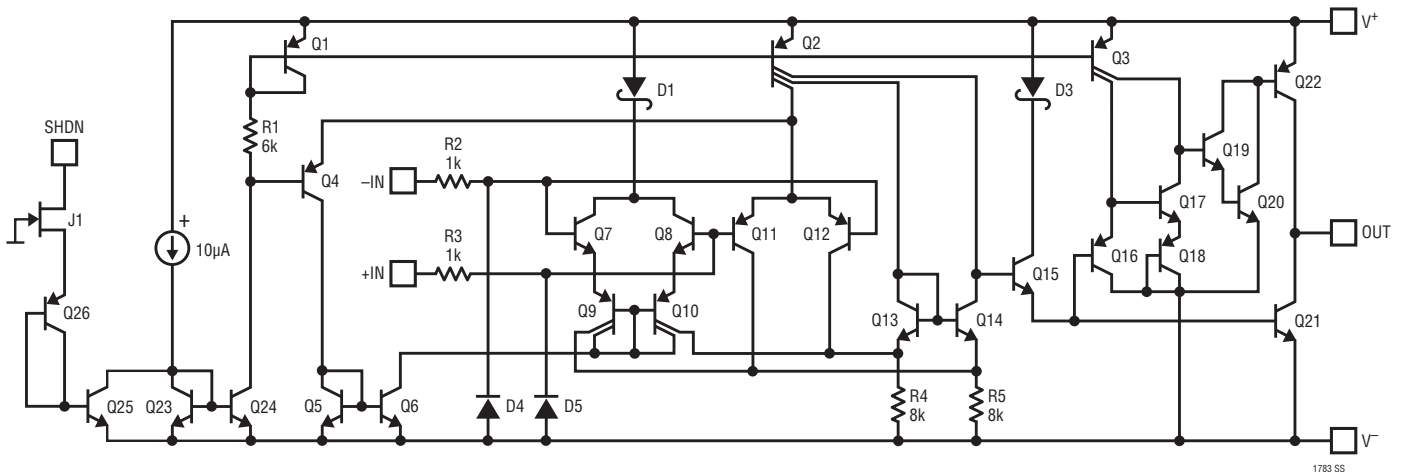

# TYPICAL APPLICATION

## Protected Fault Conditions

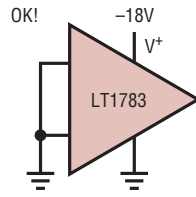

REVERSE BATTERY

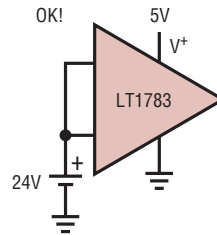

INPUT OVERVOLTAGE

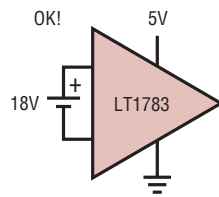

INPUT DIFFERENTIAL VOLTAGE

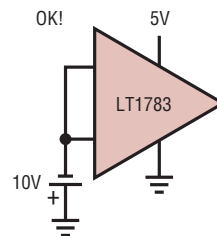

INPUTS BELOW GROUND

1783 TA03

**PACKAGE DESCRIPTION**

**S5 Package**  
**5-Lead Plastic TSOT-23**  
 (Reference LTC DWG # 05-08-1635)

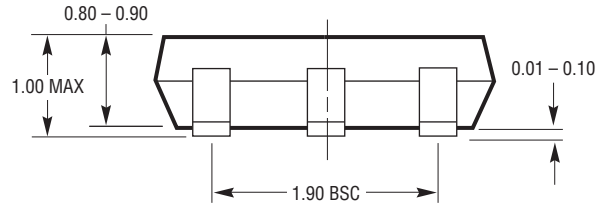
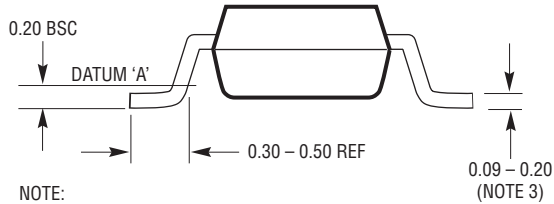
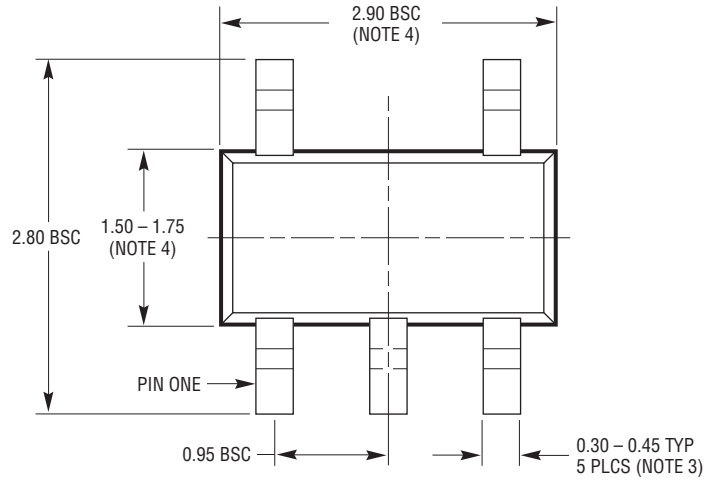
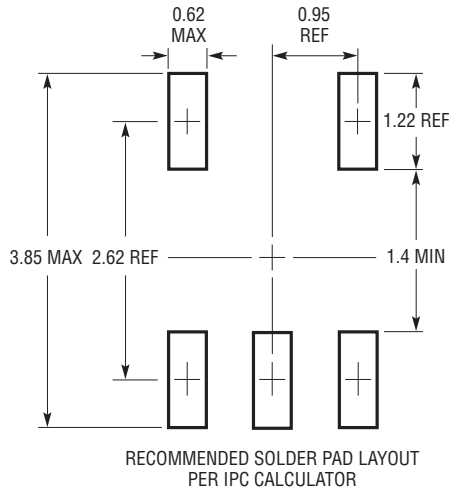

- NOTE:
1. DIMENSIONS ARE IN MILLIMETERS
  2. DRAWING NOT TO SCALE
  3. DIMENSIONS ARE INCLUSIVE OF PLATING
  4. DIMENSIONS ARE EXCLUSIVE OF MOLD FLASH AND METAL BURR
  5. MOLD FLASH SHALL NOT EXCEED 0.254mm
  6. JEDEC PACKAGE REFERENCE IS MO-193

S5 TSOT-23 0302 REV B

# PACKAGE DESCRIPTION

## S6 Package 6-Lead Plastic TSOT-23 (Reference LTC DWG # 05-08-1636)

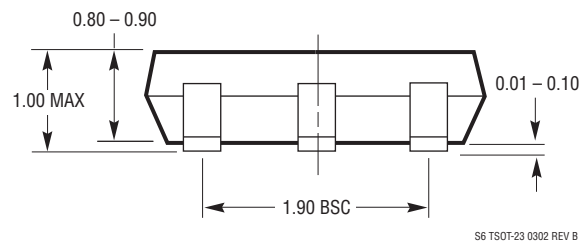
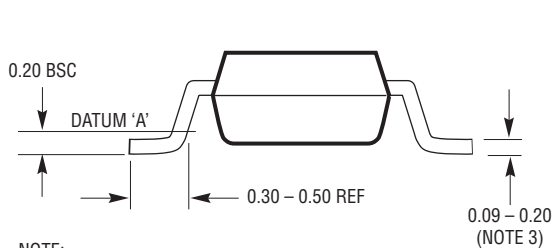
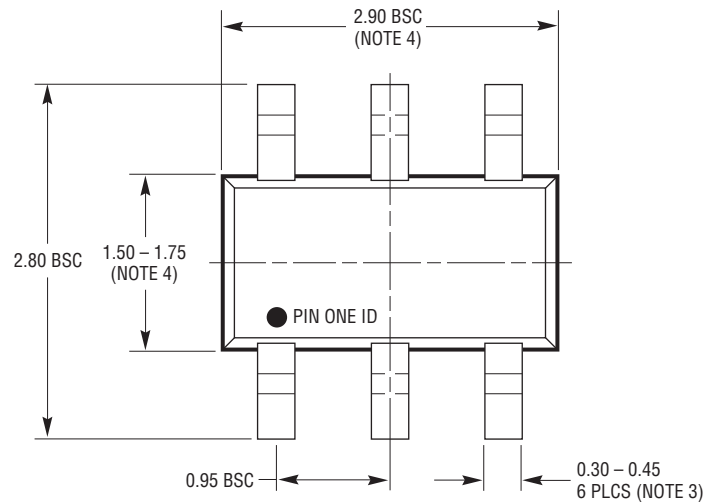
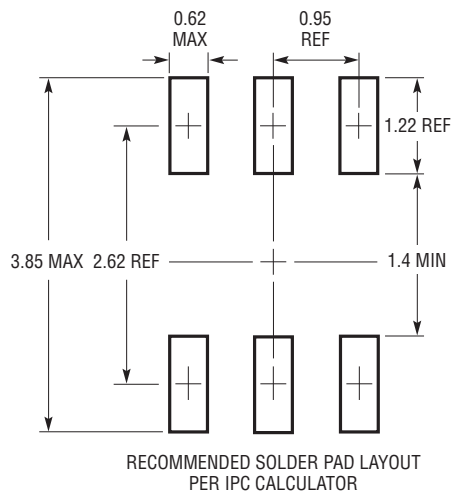

S6 TSOT-23 0302 REV B

- NOTE:
1. DIMENSIONS ARE IN MILLIMETERS
  2. DRAWING NOT TO SCALE
  3. DIMENSIONS ARE INCLUSIVE OF PLATING
  4. DIMENSIONS ARE EXCLUSIVE OF MOLD FLASH AND METAL BURR
  5. MOLD FLASH SHALL NOT EXCEED 0.254mm
  6. JEDEC PACKAGE REFERENCE IS MO-193

## TYPICAL APPLICATION

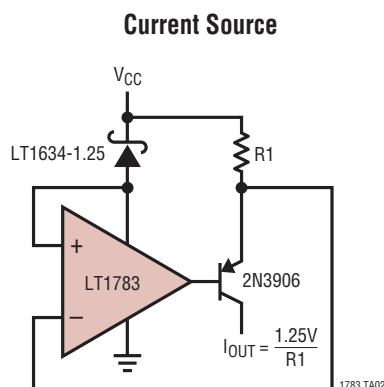

## RELATED PARTS

PART NUMBER	DESCRIPTION	COMMENTS
LT1782	Micropower, Over-The-Top SOT-23 Rail-to-Rail Input and Output Op Amp	SOT-23 Package, Micropower 40µA per Amplifier, Rail-to-Rail Input and Output , 200kHz GBW
LT1490/LT1491	Dual/Quad Over-The-Top Micropower Rail-to-Rail Input and Output Op Amps	Single Supply Input Range: -0.4V to 44V, Micropower 50µA per Amplifier, Rail-to-Rail Input and Output , 200kHz GBW
LT1636	Single Over-The-Top Micropower Rail-to-Rail Input and Output Op Amp	55µA Supply Current, $V_{CM}$ Extends 44V Above $V_{EE}$ , Independent of $V_{CC}$ , MSOP Package, Shutdown Function
LT1638/LT1639	Dual/Quad, 1.2MHz, 0.4V/µs, Over-The-Top Micropower Rail-to-Rail Input and Output Op Amps	170µA Supply Current, Single Supply Input Range: -0.4V to 44V, Rail-to-Rail Input and Output