

N-Channel Enhancement Mode Power MOSFET

MTN6680Q8

Description

The MTN6680Q8 is a N-channel enhancement-mode MOSFET, providing the designer with the best combination of fast switching, ruggedized device design, low on-resistance and cost effectiveness. The SOP-8 package is universally preferred for all commercial-industrial surface mount applications and suited for low voltage applications such as DC/DC converters.

Features

- Single Drive Requirement
- Low On-resistance
- Fast Switching Characteristic
- Dynamic dv/dt rating
- Repetitive Avalanche Rated
- Pb-free package

Symbol

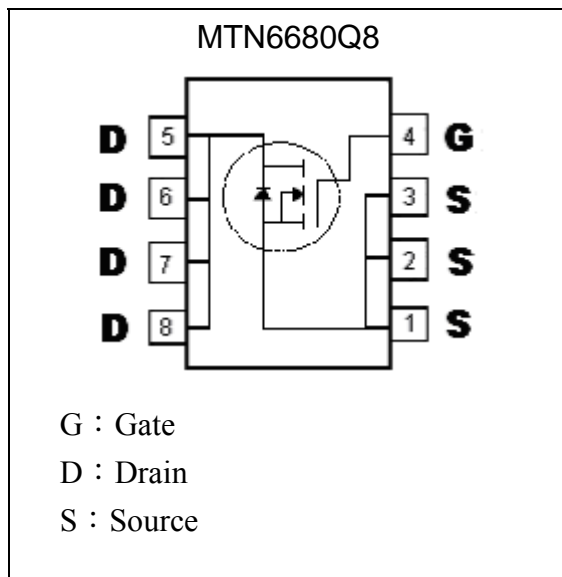

Outline

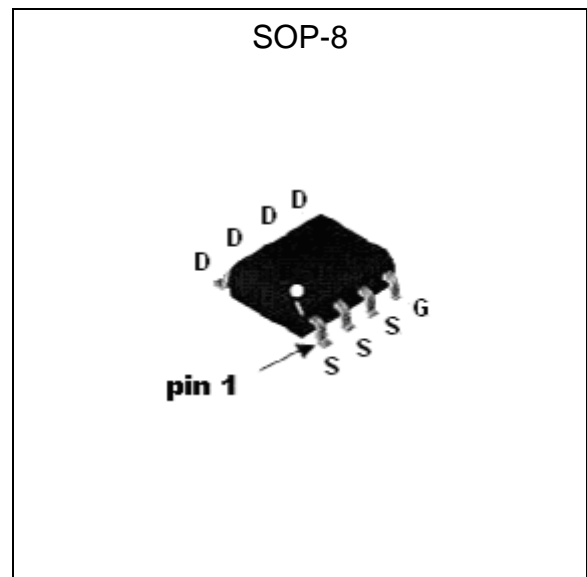



Absolute Maximum Ratings (Ta=25°C)

Parameter	Symbol	Limits	Unit
Drain-Source Voltage	V _{DS}	30	V
Gate-Source Voltage	V _{GS}	±20	V
Continuous Drain Current @V _{GS} =10V, T _A =25°C	I _D	11.5 *1	A
Continuous Drain Current @V _{GS} =10V, T _A =70°C	I _D	9.5 *1	A
Pulsed Drain Current	I _{DM}	50 *2	A
Total Power Dissipation	P _D	2.5	W
Linear Derating Factor		0.02	W/°C
Thermal Resistance, Junction-to-ambient, max	R _{th,j-a}	50 *1	°C/W
Operating Junction and Storage Temperature	T _j , T _{stg}	-55~+150	°C

Note : 1. Surface mounted on 1 in² copper pad of FR-4 board, 125°C/W when mounted on minimum copper pad.
 2. Pulse width limited by maximum junction temperature

Characteristics (T_j=25°C, unless otherwise specified)

Symbol	Min.	Typ.	Max.	Unit	Test Conditions
Static					
BV _{DSS}	30	-	-	V	V _{GS} =0, I _D =250µA
ΔBV _{DSS} /ΔT _j	-	0.02	-	V/°C	Reference to 25°C, I _D =1mA
V _{GS(th)}	1.0	-	3.0	V	V _{DS} = V _{GS} , I _D =250µA
G _{FS}	-	30	-	S	V _{DS} =15V, I _D =11.5A
I _{GSS}	-	-	±100	nA	V _{GS} =±20
I _{DSS}	-	-	1	µA	V _{DS} =30V, V _{GS} =0
I _{DSS}	-	-	25	µA	V _{DS} =24V, V _{GS} =0, T _j =70°C
*R _{DS(ON)}	-	-	11	mΩ	V _{GS} =10V, I _D =11.5A
*R _{DS(ON)}	-	-	18	mΩ	V _{GS} =4.5V, I _D =9.5A
Dynamic					
*Q _g	-	16.8	-	nC	I _D =11.5A, V _{DS} =15V, V _{GS} =5V
*Q _{gs}	-	4.2	-		
*Q _{gd}	-	8	-		
*t _{d(ON)}	-	8.9	-	ns	V _{DS} =15V, I _D =1A, V _{GS} =10V, R _G =5.5Ω, R _D =10Ω
*t _r	-	7.3	-		
*t _{d(OFF)}	-	25.6	-		
*t _f	-	18.6	-		
C _{iss}	-	1450	-	pF	V _{GS} =0V, V _{DS} =25V, f=1MHz
C _{oss}	-	285	-		
C _{rss}	-	180	-		
Source-Drain Diode					
*V _{SD}	-	-	1.3	V	I _S =3.5A, V _{GS} =0V
*I _S	-	-	1.92	A	V _D =V _G =0, V _S =1.3V

*Pulse Test : Pulse Width ≤300µs, Duty Cycles≤2%

Characteristic Curves

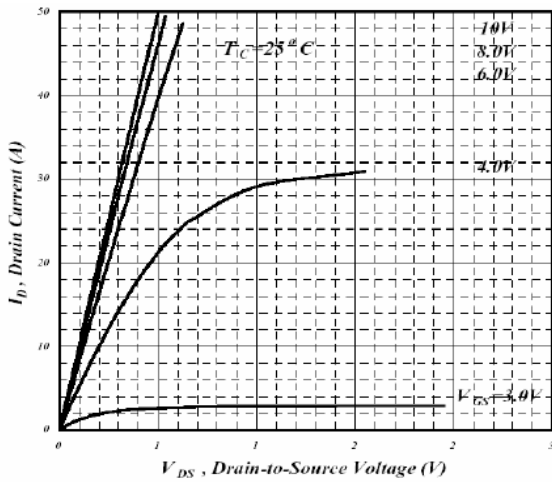

Fig 1. Typical Output Characteristics

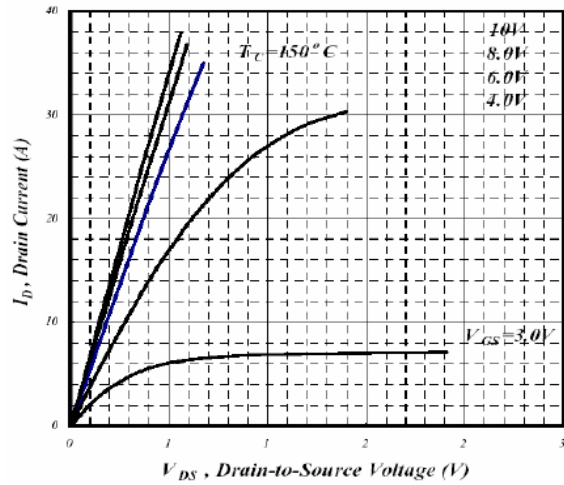

Fig 2. Typical Output Characteristics

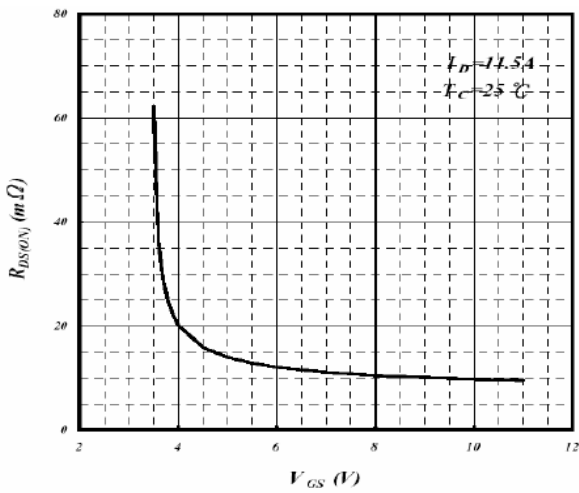

Fig 3. On-Resistance v.s. Gate Voltage

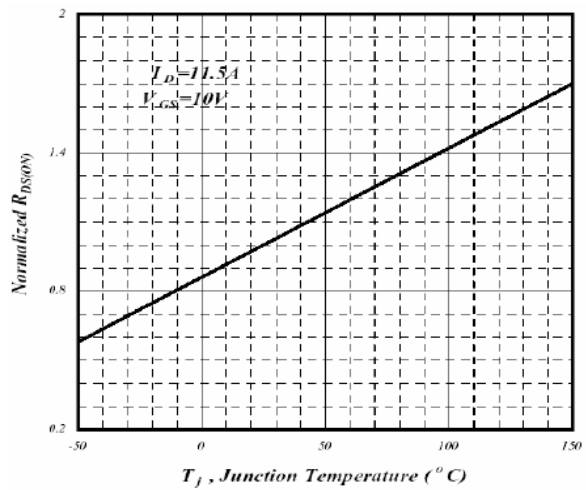

Fig 4. Normalized On-Resistance v.s. Junction Temperature

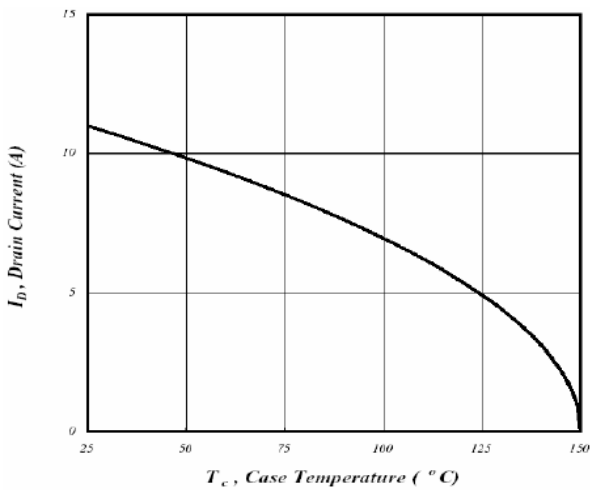

Fig 5. Maximum Drain Current v.s. Case Temperature

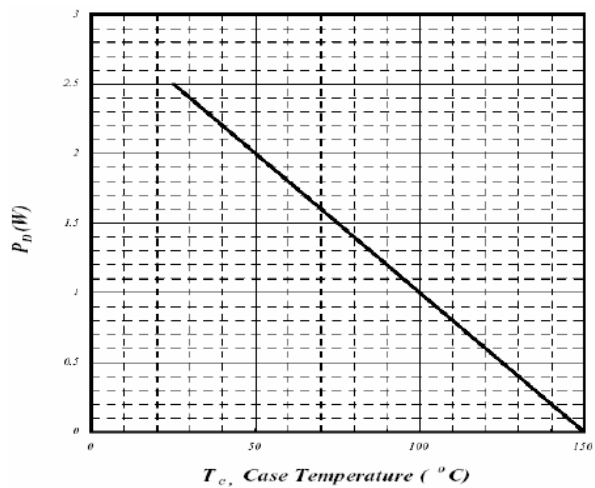

Fig 6. Type Power Dissipation

Characteristic Curves(Cont.)

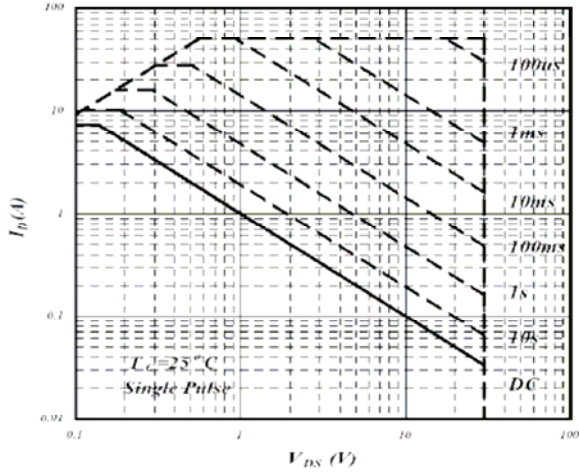

Fig 7. Maximum Safe Operating Area

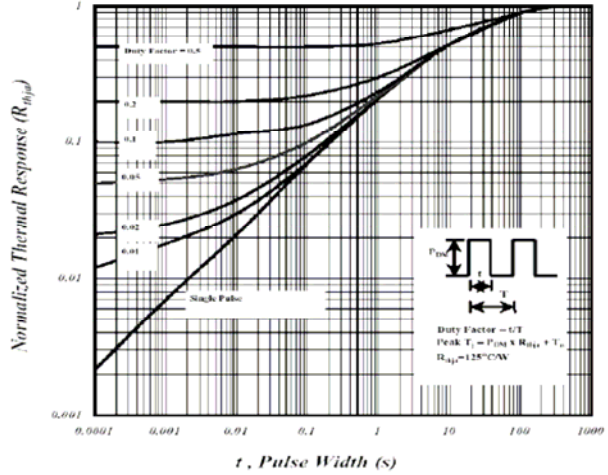

Fig 8. Effective Transient Thermal Impedance

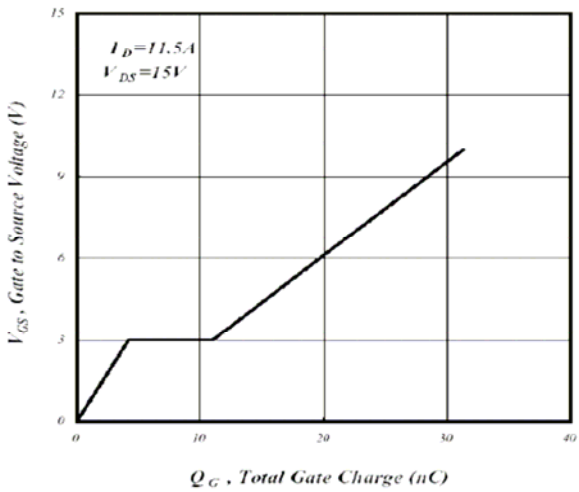

Fig 9. Gate Charge Characteristics

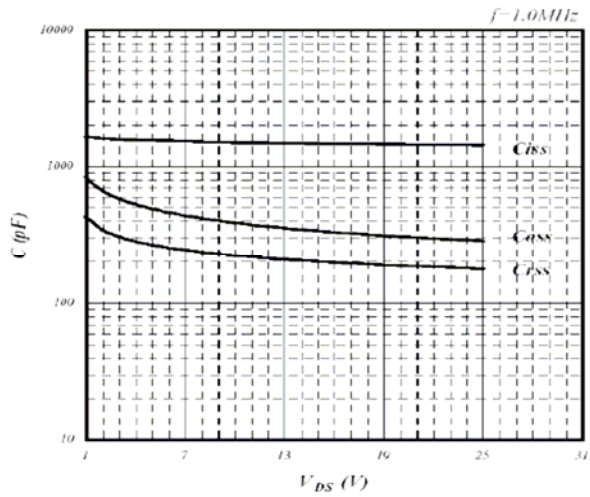

Fig 10. Typical Capacitance Characteristics

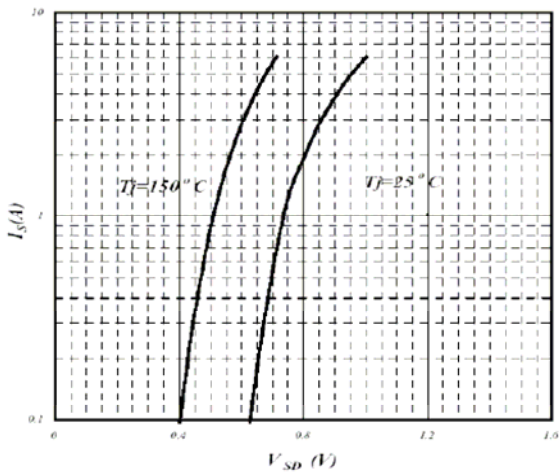

Fig 11. Forward Characteristics of Reverse Diode

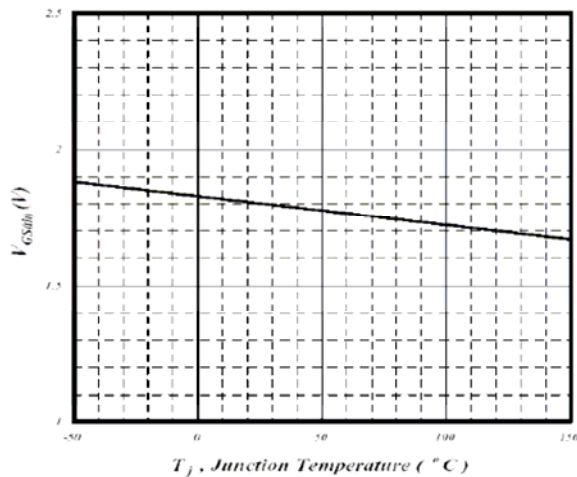

Fig 12. Gate Threshold Voltage v.s. Junction Temperature

Characteristic Curves(Cont.)

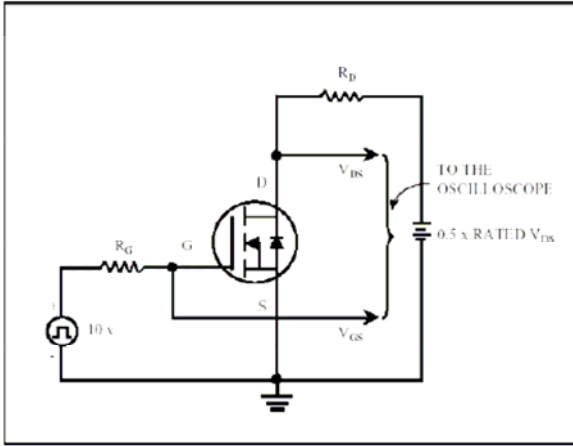

Fig 13. Switching Time Circuit

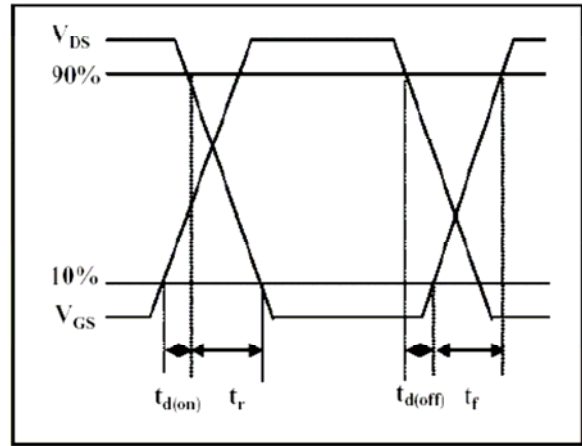

Fig 14. Switching Time Waveform

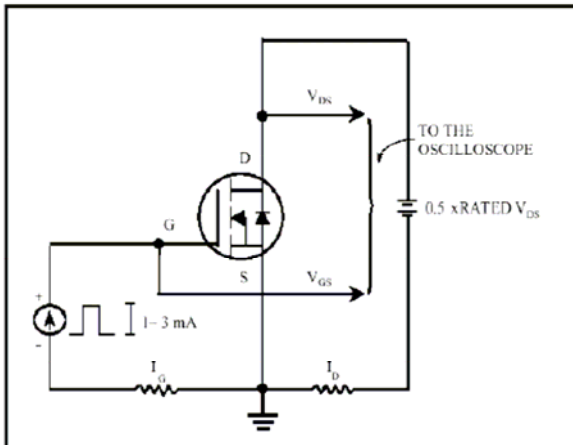

Fig 15. Gate Charge Circuit

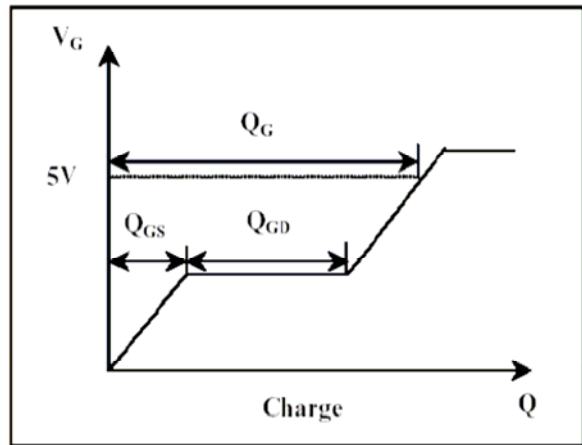
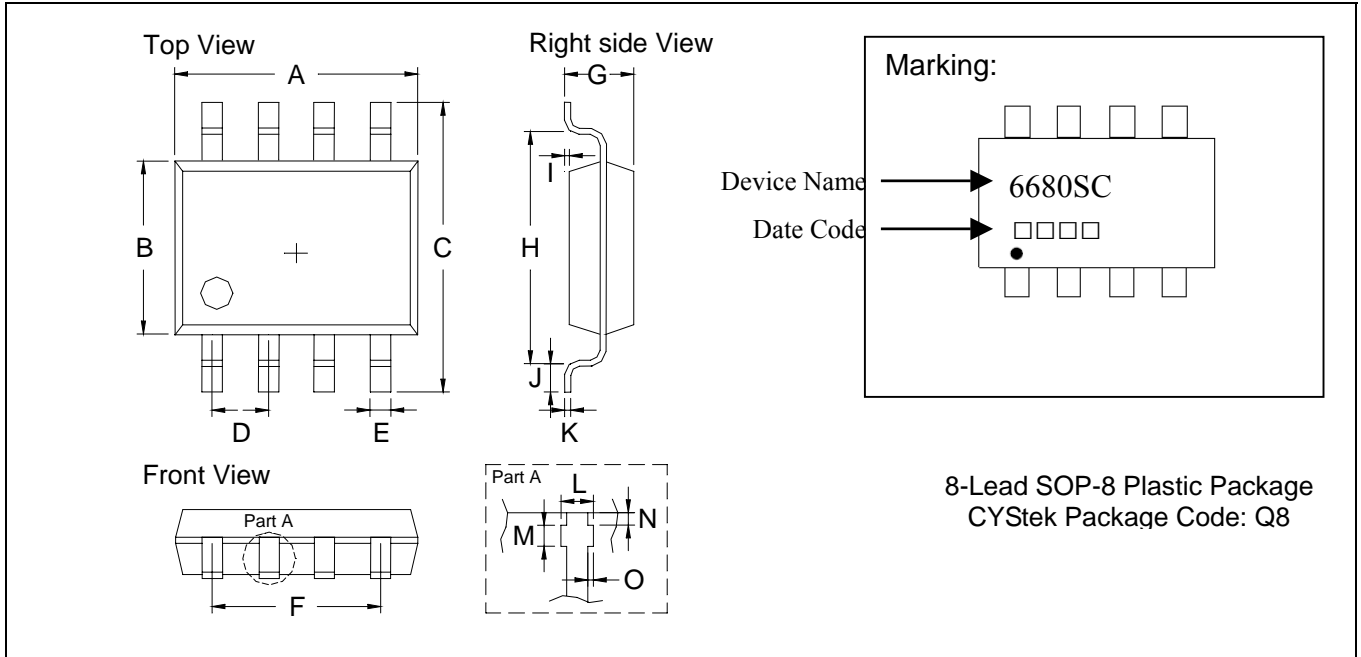

Fig 16. Gate Charge Waveform

SOP-8 Dimension



*: Typical

DIM	Inches		Millimeters		DIM	Inches		Millimeters	
	Min.	Max.	Min.	Max.		Min.	Max.	Min.	Max.
A	0.1909	0.2007	4.85	5.10	I	0.0019	0.0078	0.05	0.20
B	0.1515	0.1555	3.85	3.95	J	0.0118	0.0275	0.30	0.70
C	0.2283	0.2441	5.80	6.20	K	0.0074	0.0098	0.19	0.25
D	0.0480	0.0519	1.22	1.32	L	0.0145	0.0204	0.37	0.52
E	0.0145	0.0185	0.37	0.47	M	0.0118	0.0197	0.30	0.50
F	0.1472	0.1527	3.74	3.88	N	0.0031	0.0051	0.08	0.13
G	0.0570	0.0649	1.45	1.65	O	0.0000	0.0059	0.00	0.15
H	0.1889	0.2007	4.80	5.10					

Notes: 1.Controlling dimension: millimeters.
 2.Maximum lead thickness includes lead finish thickness, and minimum lead thickness is the minimum thickness of base material.
 3.If there is any question with packing specification or packing method, please contact your local CYStek sales office.

Material:

- Lead: 42 Alloy; solder plating
- Mold Compound: Epoxy resin family, flammability solid burning class: UL94V-0

Important Notice:

- All rights are reserved. Reproduction in whole or in part is prohibited without the prior written approval of CYStek.
- CYStek reserves the right to make changes to its products without notice.
- CYStek **semiconductor products are not warranted to be suitable for use in Life-Support Applications, or systems.**
- CYStek assumes no liability for any consequence of customer product design, infringement of patents, or application assistance.