

Features

- 225W Peak Pulse Power Dissipation (10 μ s x 1000 μ s waveform)
- 5.0V - 51V Standoff Voltages
- Excellent Clamping Capability
- **Lead Free Finish, RoHS Compliant (Note 6)**
- **"Green" Molding Compound (No Br, Sb)**
- **Qualified to AEC-Q101 Standards for High Reliability**

Mechanical Data

- Case: PowerDI®123
- Case Material: Molded Plastic, "Green" Molding Compound. UL Flammability Classification Rating 94V-0
- Moisture Sensitivity: Level 1 per J-STD-020D
- Terminal Connections: Cathode Band
- Terminals: Finish — Matte Tin annealed over Copper leadframe. Solderable per MIL-STD-202, Method 208 ③
- Marking Information: See Page 3
- Ordering Information: See Page 3
- Weight: 0.01 grams (approximate)



Top View

Maximum Ratings @T_A = 25°C unless otherwise specified

Characteristic	Symbol	Value	Unit
Peak Pulse Power Dissipation (Note 1) 10/1000 μ s (Note 2) 8/20 μ s	P _{PK}	225 1125	W
Peak Forward Surge Current, 8.3ms Single Half Sine Wave	I _{FSM}	50	A
Instantaneous Forward Voltage @ I _{PP} = 12A (Note 5)	V _F	3.5	V

Thermal Characteristics

Characteristic	Symbol	Value	Unit
DC Steady-State Power Dissipation (Note 3)	P _D	1.0	W
Thermal Resistance, Junction to Ambient (Note 3)	R _{θJA}	125	°C/W
Thermal Resistance, Junction to Soldering Point (Note 4)	R _{θJS}	6	°C/W
Operating and Storage Temperature Range	T _J , T _{STG}	-65 to +150	°C

- Notes:
1. Non-Repetitive current pulse as shown in figure 2 and derated above T_A = 25°C as per figure 1.
 2. Non-Repetitive current pulse as shown in figure 3 and derated above T_A = 25°C as per figure 1.
 3. Device mounted on 1"x1", FR-4 PCB; 2 oz. Cu pad layout as shown on Diodes Inc. suggested pad layout document AP02001.pdf.
 4. Theoretical R_{θJS} calculated from the top center of the die straight down to the PCB/cathode tab solder junction.
 5. 1/2 sine wave (or equivalent square wave), pulse width = 8.3ms, duty cycle = 4 pulses/minute maximum.
 6. EU Directive 2002/95/EC (RoHS). All applicable RoHS exemptions applied. Please visit our website at http://www.diodes.com/products/lead_free.html.

Electrical Characteristics @T_A = 25°C unless otherwise specified

Part Number	Reverse Standoff Voltage	Breakdown Voltage V _{BR} @ I _T (Note 7)		Test Current	Max. Reverse Leakage @ V _{RWM}	Max. Clamping Voltage @ I _{pp}	Max. Peak Pulse Current I _{pp}	Marking Code
	V _{RWM} (V)	Min (V)	Max (V)	I _T (mA)	I _R (μA)	V _C (V)	(A)	
DFLT5V0A	5.0	6.40	7.0	10	400	9.2	24.5	FAE
DFLT6V0A	6.0	6.67	7.37	10	400	10.3	21.8	FAG
DFLT6V5A	6.5	7.22	7.98	10	250	11.2	20.1	FAK
DFLT7V0A	7.0	7.78	8.60	10	100	12.0	18.8	FAM
DFLT7V5A	7.5	8.33	9.21	1.0	50	12.9	17.4	FAP
DFLT8V0A	8.0	8.89	9.83	1.0	25	13.6	16.5	FAR
DFLT8V5A	8.5	9.44	10.4	1.0	10	14.4	15.6	FAT
DFLT9V0A	9.0	10.0	11.1	1.0	5.0	15.4	14.6	FAV
DFLT10A	10	11.1	12.3	1.0	2.5	17.0	13.2	FAX
DFLT11A	11	12.2	13.5	1.0	2.5	18.2	12.4	FAZ
DFLT12A	12	13.3	14.7	1.0	2.5	19.9	11.3	FBE
DFLT13A	13	14.4	15.9	1.0	1.0	21.5	10.5	FBG
DFLT14A	14	15.6	17.2	1.0	1.0	23.2	9.7	FBK
DFLT15A	15	16.7	18.5	1.0	1.0	24.4	9.22	FBM
DFLT16A	16	17.8	19.7	1.0	1.0	26.0	8.65	FBP
DFLT17A	17	18.9	20.9	1.0	1.0	27.6	8.15	FBR
DFLT18A	18	20.0	22.1	1.0	1.0	29.2	7.71	FBT
DFLT20A	20	22.2	24.5	1.0	1.0	32.4	6.94	FBV
DFLT22A	22	24.4	26.9	1.0	1.0	35.5	6.34	FBX
DFLT24A	24	26.7	29.5	1.0	1.0	38.9	5.78	FBZ
DFLT26A	26	28.9	31.9	1.0	1.0	42.1	5.35	FCE
DFLT27A	27	30	33.15	1.0	1.0	43.7	5.15	FCF
DFLT28A	28	31.1	34.4	1.0	1.0	45.4	4.96	FCG
DFLT30A	30	33.3	36.8	1.0	1.0	48.4	4.65	FKC
DFLT33A	33	36.7	40.6	1.0	1.0	53.3	4.22	FCM
DFLT36A	36	40.0	44.2	1.0	1.0	58.1	3.87	FCP
DFLT40A	40	44.4	49.1	1.0	1.0	64.5	3.49	FCR
DFLT43A	43	47.8	52.8	1.0	1.0	69.4	3.24	FCT
DFLT45A	45	50.0	55.3	1.0	1.0	72.7	3.10	FCV
DFLT48A	48	53.3	58.9	1.0	1.0	77.4	2.91	FCX
DFLT51A	51	56.7	62.7	1.0	1.0	82.4	2.73	FCZ

Notes: 7. V_{BR} measured at pulse test current I_T with t_p ≤ 5.0ms at T_A = 25°C.

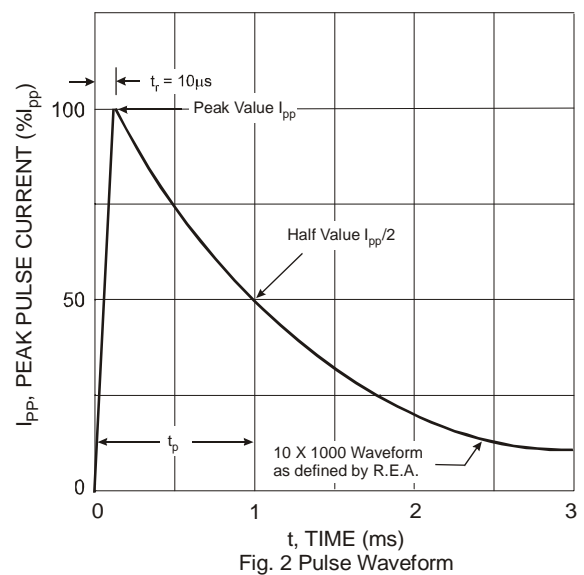
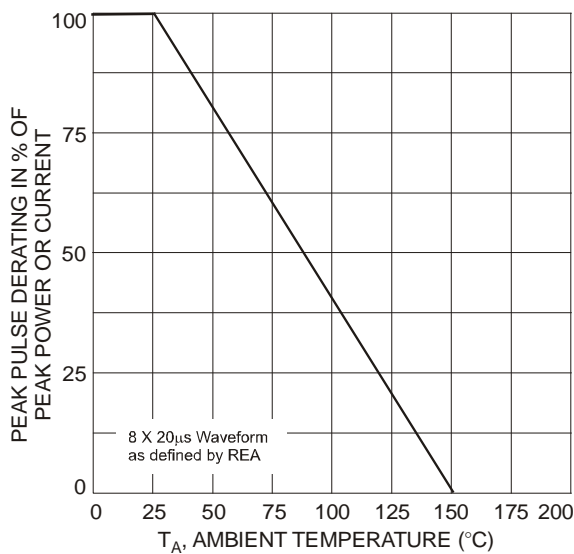

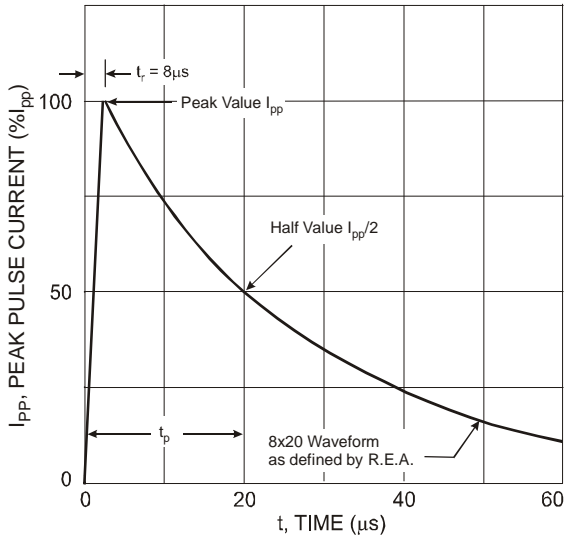

Fig. 3 Pulse Waveform

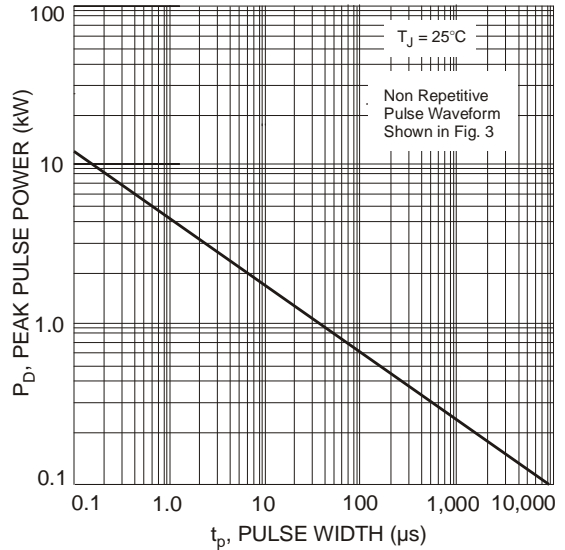

Fig. 4 Pulse Rating Curve

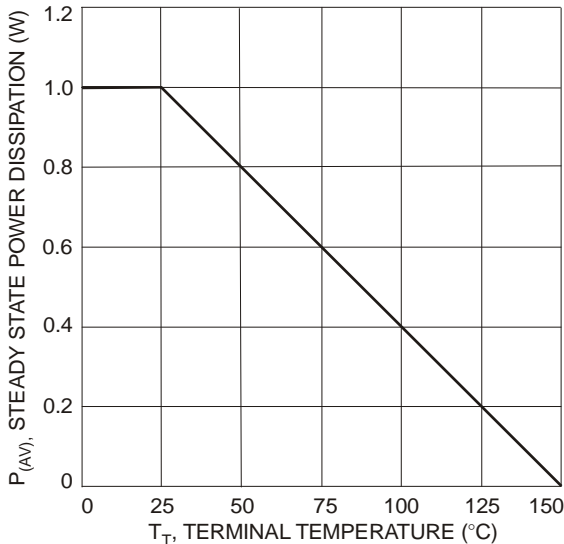

Fig. 5 Steady State Power Derating Curve

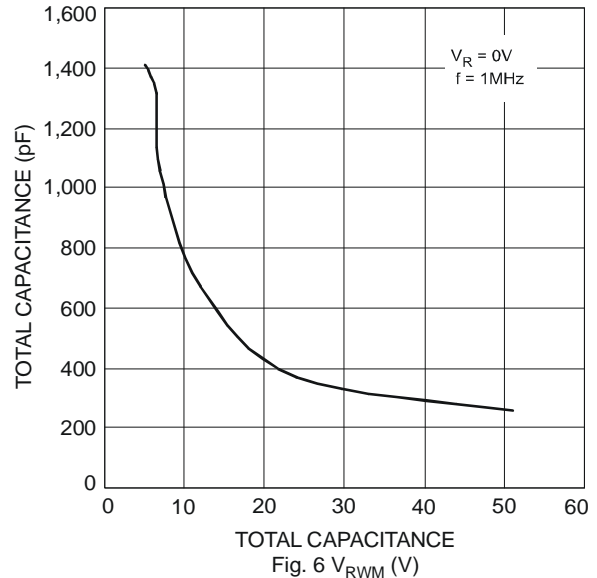

Fig. 6 V_{RWM} (V)

Ordering Information (Note 8)

Part Number	Case	Packaging
DFLTxxxA-7*	PowerDI®123	3000/Tape & Reel

* Add "-7" to the appropriate type number in Electrical Characteristics Table on page 2. Example: 10V reverse standoff device = DFLT10A-7.

Notes: 8. For packaging details, go to our website at <http://www.diodes.com/datasheets/ap02007.pdf>.

Marking Information

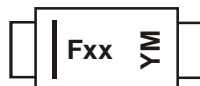

Fxx = Product Type Marking Code,
See Electrical Characteristics Table on Page 2
YM = Date Code Marking
Y = Year (ex: R = 2004)
M = Month (ex: 9 = September)

Date Code Key

Year	2004	2005	2006	2007	2008	2009	2010	2011	2012	2013	2014	2015
Code	R	S	T	U	V	W	X	Y	Z	A	B	C

Month	Jan	Feb	Mar	Apr	May	Jun	Jul	Aug	Sep	Oct	Nov	Dec
Code	1	2	3	4	5	6	7	8	9	O	N	D

PowerDI is a registered trademark of Diodes Incorporated.

Package Outline Dimensions

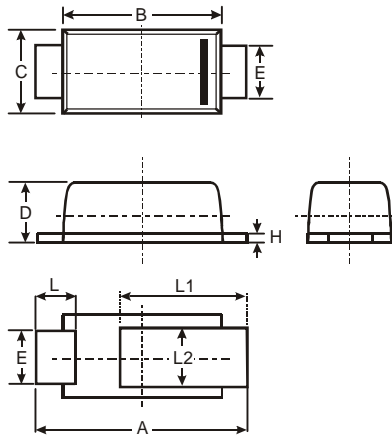

PowerDI [®] 123			
Dim	Min	Max	Typ
A	3.50	3.90	3.70
B	2.60	3.00	2.80
C	1.63	1.93	1.78
D	0.93	1.00	0.98
E	0.85	1.25	1.00
H	0.15	0.25	0.20
L	0.55	0.75	0.65
L1	1.80	2.20	2.00
L2	0.95	1.25	1.10
All Dimensions in mm			

Suggested Pad Layout

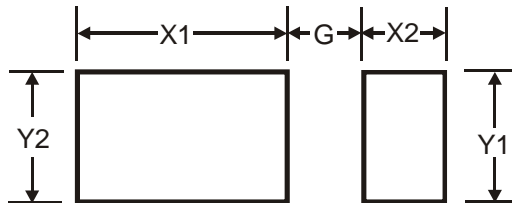

Dimensions	Value (in mm)
G	1.0
X1	2.2
X2	0.9
Y1	1.4
Y2	1.4

IMPORTANT NOTICE

DIODES INCORPORATED MAKES NO WARRANTY OF ANY KIND, EXPRESS OR IMPLIED, WITH REGARDS TO THIS DOCUMENT, INCLUDING, BUT NOT LIMITED TO, THE IMPLIED WARRANTIES OF MERCHANTABILITY AND FITNESS FOR A PARTICULAR PURPOSE (AND THEIR EQUIVALENTS UNDER THE LAWS OF ANY JURISDICTION).

Diodes Incorporated and its subsidiaries reserve the right to make modifications, enhancements, improvements, corrections or other changes without further notice to this document and any product described herein. Diodes Incorporated does not assume any liability arising out of the application or use of this document or any product described herein; neither does Diodes Incorporated convey any license under its patent or trademark rights, nor the rights of others. Any Customer or user of this document or products described herein in such applications shall assume all risks of such use and will agree to hold Diodes Incorporated and all the companies whose products are represented on Diodes Incorporated website, harmless against all damages.

Diodes Incorporated does not warrant or accept any liability whatsoever in respect of any products purchased through unauthorized sales channel. Should Customers purchase or use Diodes Incorporated products for any unintended or unauthorized application, Customers shall indemnify and hold Diodes Incorporated and its representatives harmless against all claims, damages, expenses, and attorney fees arising out of, directly or indirectly, any claim of personal injury or death associated with such unintended or unauthorized application.

Products described herein may be covered by one or more United States, international or foreign patents pending. Product names and markings noted herein may also be covered by one or more United States, international or foreign trademarks.

LIFE SUPPORT

Diodes Incorporated products are specifically not authorized for use as critical components in life support devices or systems without the express written approval of the Chief Executive Officer of Diodes Incorporated. As used herein:

A. Life support devices or systems are devices or systems which:

1. are intended to implant into the body, or
2. support or sustain life and whose failure to perform when properly used in accordance with instructions for use provided in the labeling can be reasonably expected to result in significant injury to the user.

B. A critical component is any component in a life support device or system whose failure to perform can be reasonably expected to cause the failure of the life support device or to affect its safety or effectiveness.

Customers represent that they have all necessary expertise in the safety and regulatory ramifications of their life support devices or systems, and acknowledge and agree that they are solely responsible for all legal, regulatory and safety-related requirements concerning their products and any use of Diodes Incorporated products in such safety-critical, life support devices or systems, notwithstanding any devices- or systems-related information or support that may be provided by Diodes Incorporated. Further, Customers must fully indemnify Diodes Incorporated and its representatives against any damages arising out of the use of Diodes Incorporated products in such safety-critical, life support devices or systems.

Copyright © 2009, Diodes Incorporated

www.diodes.com