



SPE0562

Single-Line ESD Protection Array

DESCRIPTION

The SPE0562 are designed by TVS bi-direction device that is to protect sensitive electronics from damage or latch-up due to ESD. They are designed for use in applications where board space is at a premium. SPE0562 will protect single line, and may be used on line where the signal polarities swing above and below ground.

SPE0562 offer desirable characteristics for board level protection including fast response time, low operating and clamping voltage, and no device degradation.

SPE0562 may be used to meet the immunity requirements of IEC 61000-4-2, level 4. The small SOD-323 package makes them ideal for use in portable electronics such as cell phones, PDA's, notebook computers, and digital cameras.

APPLICATIONS

- ◆ Cellular Handsets and Accessories
- ◆ Cordless Phone
- ◆ PDA
- ◆ Notebooks and Handhelds
- ◆ Portable Instrumentation
- ◆ Digital Cameras
- ◆ MP3 Player

FEATURES

- ◆ Transient protection for data lines to IEC 61000-4-2 (ESD) $\pm 15\text{kV}$ (air), $\pm 8\text{kV}$ (contact)
IEC 61000-4-4 (EFT) 40A (5/50ns)
- ◆ Protects single I/O lines
- ◆ Working voltage: 5V
- ◆ Low leakage current
- ◆ Low operating and clamping voltages

PIN CONFIGURATION (SOD-323)

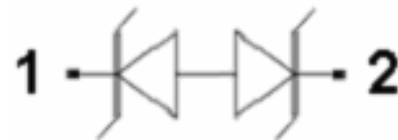

PART MARKING

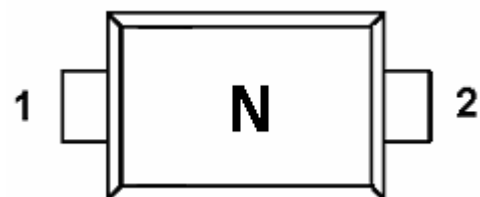



SPE0562

Single-Line ESD Protection Array

ORDERING INFORMATION

Part Number	Package	Part Marking
SPE0562D32RG	SOD-323	N
SPE0562D32RGB	SOD-323	N

- ※ SPE0562D32RG : Tape Reel ; Pb – Free
- ※ SPE0562D32RGB : Tape Reel ; Pb – Free ; Halogen - Free

ABSOLUTE MAXIMUM RATINGS

(TA=25°C Unless otherwise noted)

Parameter	Symbol	Typical	Unit
Peak Pulse Power (tp = 8/20 μs)	Ppk	250	W
Maximum Peak Pulse Current (tp = 8/20 μs)	Ipp	7	A
ESD per ICE 61000 – 4 – 2 (Air)	Vpp	±15	KV
ESD per ICE 61000 – 4 – 2 (Contact)	Vpp	±8	KV
Operating Junction Temperature	Tj	-55 ~ 150	°C
Storage Temperature Range	TSTG	-55 ~ 150	°C
Lead Soldering Temperature	TL	260 (10sec)	°C

ELECTRICAL CHARACTERISTICS

(TA=25°C Unless otherwise noted)

Parameter	Symbol	Conditions	Min.	Typ	Max.	Unit
Reverse Stand – Off Voltage	VRWM				5	V
Reverse Breakdown Voltage	VBR	It = 1mA	6			V
Reverse Leakage Current	IR	VRWM = 5V , T=25°C		0.01	1	μA
Reverse Leakage Current	IR	VRWM = 3V , T=25°C		0.01	0.5	μA
Clamping Voltage	Vc	Ipp = 1A , tp = 8/20 μs			13	V
Clamping Voltage	Vc	Ipp = 7A , tp = 8/20 μs			15	V
Junction Capacitance	Cj	Between I/O Pin and GND VR = 0V , f = 1MHz		5	10	pF



SPE0562 Single-Line ESD Protection Array

TYPICAL CHARACTERISTICS

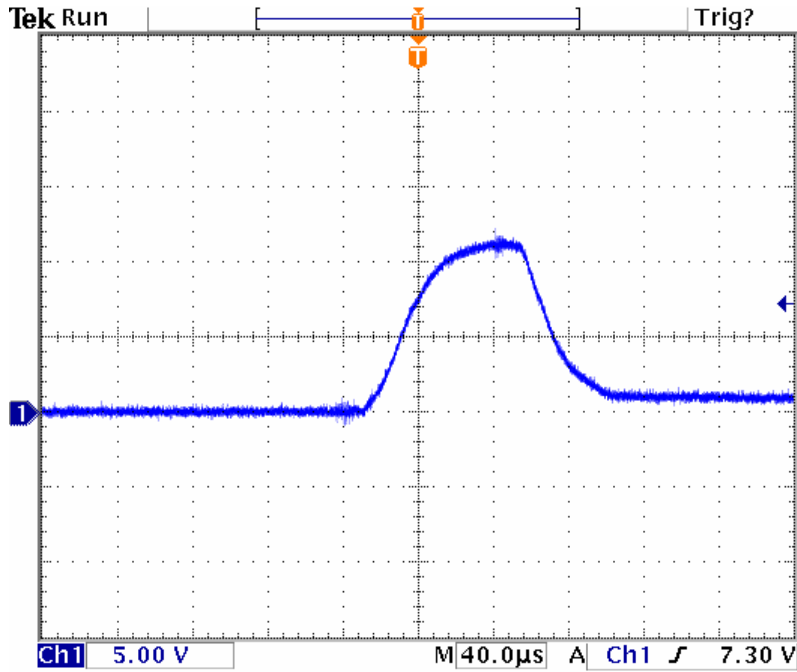

-40.0000ns

Clamping Voltage ($I_{pp} = 1A$, $t_p = 8/20 \mu s$)

26 Oct 2005
12:15:46

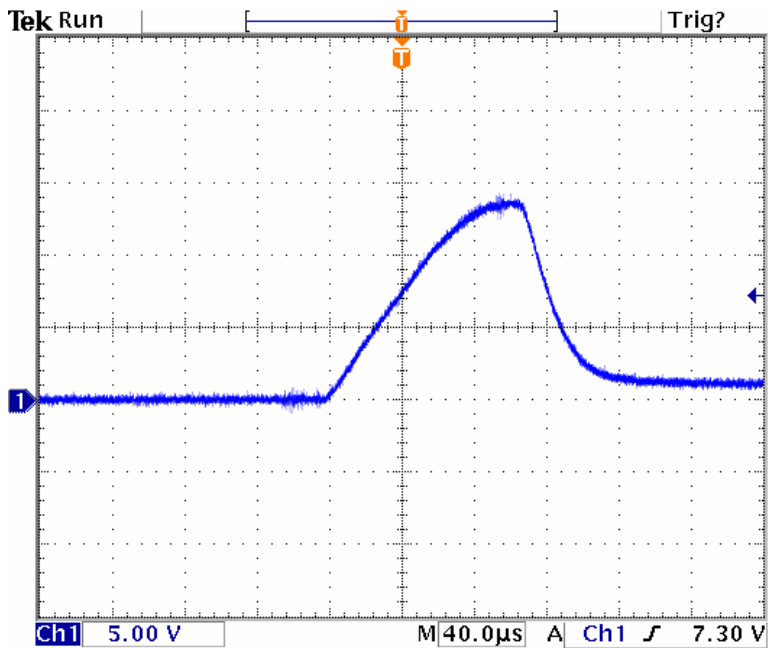

-40.0000ns

Clamping Voltage ($I_{pp} = 7A$, $t_p = 8/20 \mu s$)

26 Oct 2005
12:08:20



SPE0562 Single-Line ESD Protection Array

TYPICAL CHARACTERISTICS

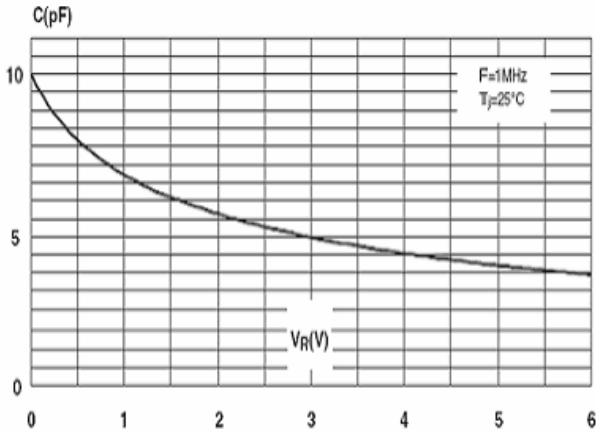

Fig 1 : Junction Capacitance V.S Reverse Voltage Applied

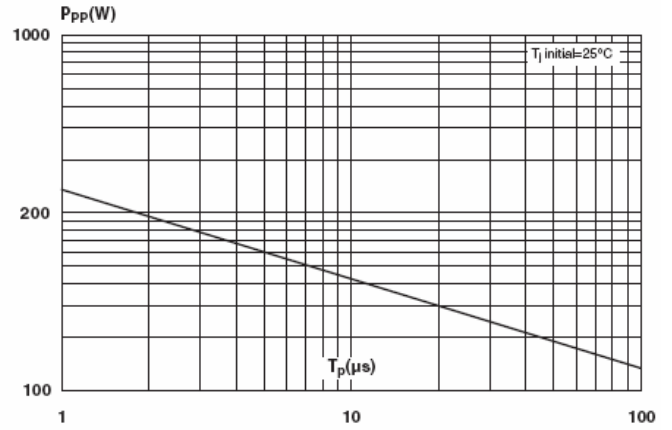

Fig 2 : Peak Plus Power V.S Exponential Plus Duration

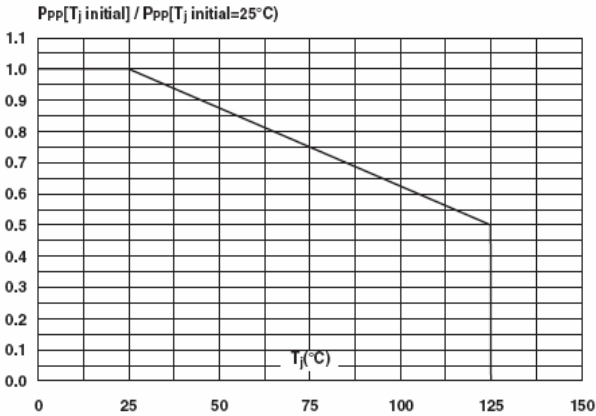

Fig 3 : Relative Variation of Peak Plus Power V.S Initial Junction Temperature

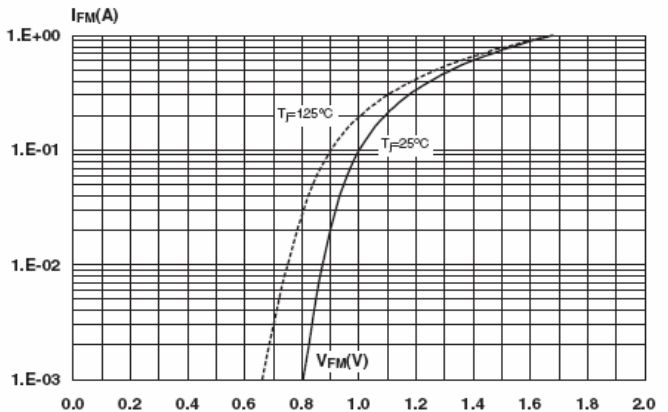
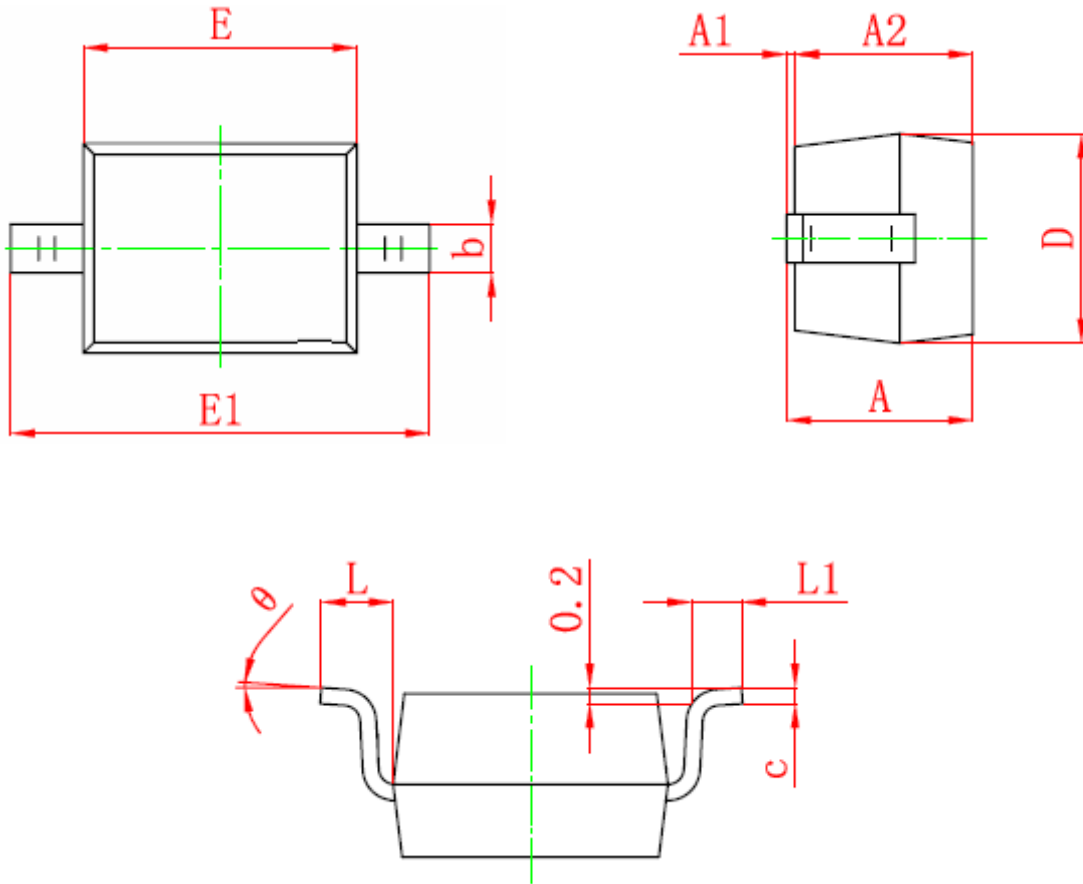

Fig 4 : Forward Voltage Drop V.S Peak Forward Current



SPE0562 Single-Line ESD Protection Array

SOD-323 PACKAGE OUTLINE



Symbol	Dimensions In Millimeters		Dimensions In Inches	
	Min	Max	Min	Max
A		1.000		0.039
A1	0.000	0.100	0.000	0.004
A2	0.800	0.900	0.031	0.035
b	0.250	0.350	0.010	0.014
c	0.080	0.150	0.003	0.006
D	1.200	1.400	0.047	0.055
E	1.600	1.800	0.063	0.071
E1	2.500	2.700	0.098	0.106
L	0.475 REF		0.019 REF	
L1	0.250	0.400	0.010	0.016
θ	0°	8°	0°	8°



SPE0562

Single-Line ESD Protection Array

Information provided is alleged to be exact and consistent. SYNC Power Corporation presumes no responsibility for the penalties of use of such information or for any violation of patents or other rights of third parties which may result from its use. No license is granted by allegation or otherwise under any patent or patent rights of SYNC Power Corporation. Conditions mentioned in this publication are subject to change without notice. This publication surpasses and replaces all information previously supplied. SYNC Power Corporation products are not authorized for use as critical components in life support devices or systems without express written approval of SYNC Power Corporation.

©The SYNC Power logo is a registered trademark of SYNC Power Corporation

©2004 SYNC Power Corporation – Printed in Taiwan – All Rights Reserved

SYNC Power Corporation

7F-2, No.3-1, Park Street

NanKang District (NKSP), Taipei, Taiwan, 115, R.O.C

Phone: 886-2-2655-8178

Fax: 886-2-2655-8468

©<http://www.syncpower.com>