

Description

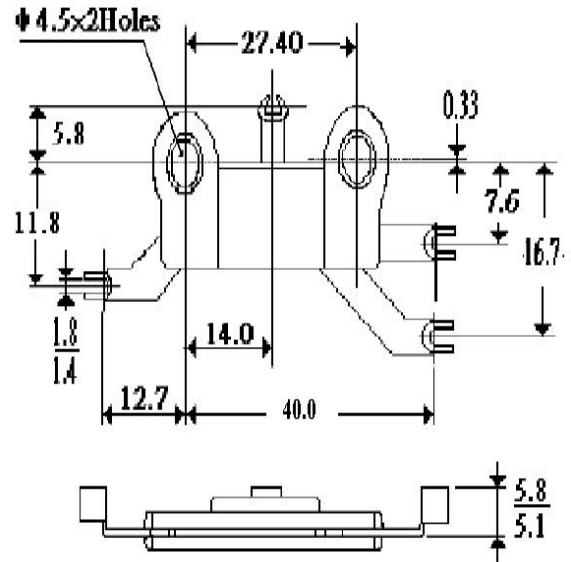

DR-1300

Mechanical Dimensions



Dimensions in inches and (millimeters)

Features

- ★ Low forward voltage drop
- ★ High current capability
- ★ High reliability
- ★ High surge current capability

Mechanical Data

- ★ Case: OFC Heat Sink
- ★ Encap: Epoxy Sealed Rated
UL94V-0
- ★ Weight: 6.4 gram

MAXIMUM RATINGS AND ELECTRICAL CHARACTERISTICS

Rating at 25°C ambient temperature unless otherwise specified.

	SYMBOL	FTD1300	UNIT
DC Reverse Voltage, VR	VR	200	V
Peak forward surge current 8.3ms single half sine wave	IFSM	150	A
Peak Rectifier Forward Current Alternator Rated Current	I(AV)	5.0	A
Maximum Inst. Forward Voltage Drop, IF at 80Amp	VF	1.05	V
Maximum DC Reverse Current (VB)@TJ=25°C (VB)@TJ=100°C	IR	5 / 500	uA
Operating Junction and Storage Temperature Range	TJ, TSTG	-40 to +155	°C