

# FGPF70N30T

## 300V, 70A PDP IGBT



### Features

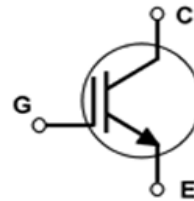
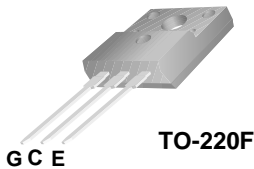
- High current capability
- Low saturation voltage:  $V_{CE(sat)} = 1.5V @ I_C = 40A$
- High input impedance
- Fast switching
- RoHS compliant

### General Description

Using Novel Trench IGBT Technology, Fairchild's new series of trench IGBTs offer the optimum performance for PDP applications where low conduction and switching losses are essential.

### Application

. PDP System



### Absolute Maximum Ratings

Symbol	Description	Ratings	Units	
$V_{CES}$	Collector-Emitter Voltage	300	V	
$V_{GES}$	Gate-Emitter Voltage	$\pm 30$	V	
$I_C \text{ pulse}(1)^*$	Pulsed Collector Current	@ $T_C = 25^\circ C$	160	A
$P_D$	Maximum Power Dissipation	@ $T_C = 25^\circ C$	49.2	W
	Maximum Power Dissipation	@ $T_C = 100^\circ C$	19.7	W
$T_J$	Operating Junction Temperature	-55 to +150	$^\circ C$	
$T_{stg}$	Storage Temperature Range	-55 to +150	$^\circ C$	
$T_L$	Maximum Lead Temp. for soldering Purposes, 1/8" from case for 5 seconds	300	$^\circ C$	

### Thermal Characteristics

Symbol	Parameter	Typ.	Max.	Units
$R_{\theta JC}(\text{IGBT})$	Thermal Resistance, Junction-to-Case	--	2.54	$^\circ C/W$
$R_{\theta JA}$	Thermal Resistance, Junction-to-Ambient	--	62.5	$^\circ C/W$

**Notes:**

(1) Repetitive test, pulse width = 100usec, Duty = 0.1

\*  $I_C$  pulse limited by max  $T_J$

## Package Marking and Ordering Information

Device Marking	Device	Package	Packaging Type	Qty per Tube	Max Qty per Box
FGPF70N30T	FGPF70N30TTU	TO-220F	Tube	50ea	-

## Electrical Characteristics T<sub>C</sub> = 25°C unless otherwise noted

Symbol	Parameter	Test Conditions	Min.	Typ.	Max.	Units
<b>Off Characteristics</b>						
BV <sub>CES</sub>	Collector-Emitter Breakdown Voltage	V <sub>GE</sub> = 0V, I <sub>C</sub> = 250uA	300	--	--	V
ΔB <sub>V<sub>CES</sub></sub> / ΔT <sub>J</sub>	Temperature Coefficient of Breakdown Voltage	V <sub>GE</sub> = 0V, I <sub>C</sub> = 250uA	--	0.2	--	V/°C
I <sub>CES</sub>	Collector Cut-Off Current	V <sub>CE</sub> = V <sub>CES</sub> , V <sub>GE</sub> = 0V	--	--	250	uA
I <sub>GES</sub>	G-E Leakage Current	V <sub>GE</sub> = V <sub>GES</sub> , V <sub>CE</sub> = 0V	--	--	± 400	nA
<b>On Characteristics</b>						
V <sub>GE(th)</sub>	G-E Threshold Voltage	I <sub>C</sub> = 250uA, V <sub>CE</sub> = V <sub>GE</sub>	3.0	4.5	5.5	V
V <sub>CE(sat)</sub>	Collector to Emitter Saturation Voltage	I <sub>C</sub> = 20A, V <sub>GE</sub> = 15V	--	1.2	1.5	V
		I <sub>C</sub> = 40A, V <sub>GE</sub> = 15V	--	1.5	--	V
		I <sub>C</sub> = 70A, V <sub>GE</sub> = 15V T <sub>C</sub> = 25°C	--	1.8	--	V
		I <sub>C</sub> = 70A, V <sub>GE</sub> = 15V T <sub>C</sub> = 125°C	--	1.9	--	V
<b>Dynamic Characteristics</b>						
C <sub>ies</sub>	Input Capacitance	V <sub>CE</sub> = 30V, V <sub>GE</sub> = 0V f = 1MHz	--	3000	--	pF
C <sub>oes</sub>	Output Capacitance		--	160	--	pF
C <sub>res</sub>	Reverse Transfer Capacitance		--	110	--	pF
<b>Switching Characteristics</b>						
t <sub>d(on)</sub>	Turn-On Delay Time	V <sub>CC</sub> = 200V, I <sub>C</sub> = 40A R <sub>G</sub> = 15Ω, V <sub>GE</sub> = 15V Resistive Load, T <sub>C</sub> = 25°C	--	32	--	ns
t <sub>r</sub>	Rise Time		--	90	--	ns
t <sub>d(off)</sub>	Turn-Off Delay Time		--	175	--	ns
t <sub>f</sub>	Fall Time		--	170	300	ns
t <sub>d(on)</sub>	Turn-On Delay Time	V <sub>CC</sub> = 200V, I <sub>C</sub> = 40A R <sub>G</sub> = 15Ω, V <sub>GE</sub> = 15V Resistive Load, T <sub>C</sub> = 125°C	--	30	--	ns
t <sub>r</sub>	Rise Time		--	90	--	ns
t <sub>d(off)</sub>	Turn-Off Delay Time		--	185	--	ns
t <sub>f</sub>	Fall Time		--	235	--	ns
Q <sub>g</sub>	Total Gate Charge	V <sub>CE</sub> = 200V, I <sub>C</sub> = 40A V <sub>GE</sub> = 15V	--	125	--	nC
Q <sub>ge</sub>	Gate-Emitter Charge		--	25	--	nC
Q <sub>gc</sub>	Gate-Collector Charge		--	55	--	nC

## Typical Performance Characteristics

Figure 1. Typical Output Characteristics

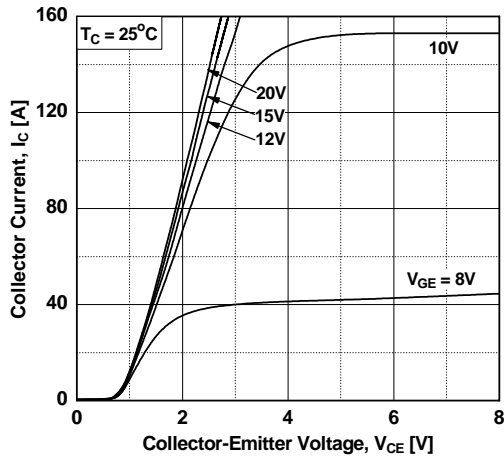


Figure 2. Typical Output Characteristics

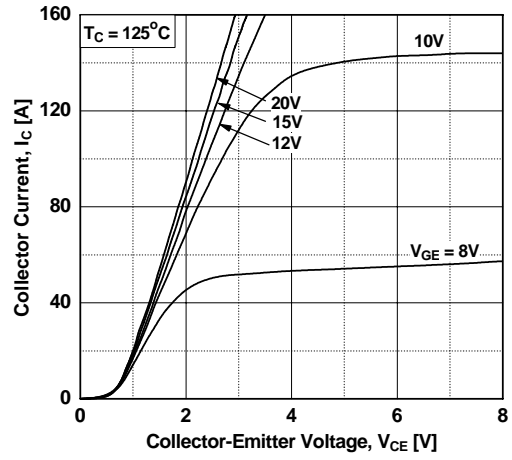


Figure 3. Typical Saturation Voltage Characteristics

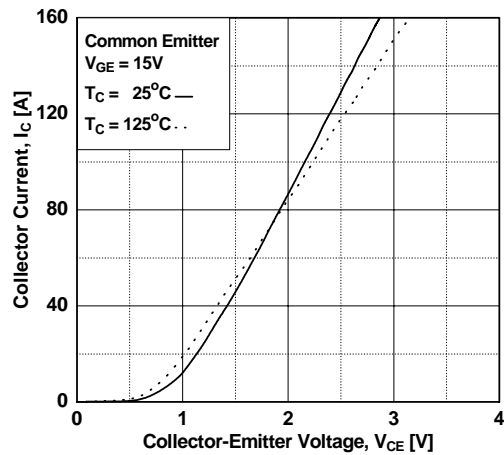


Figure 4. Transfer Characteristics

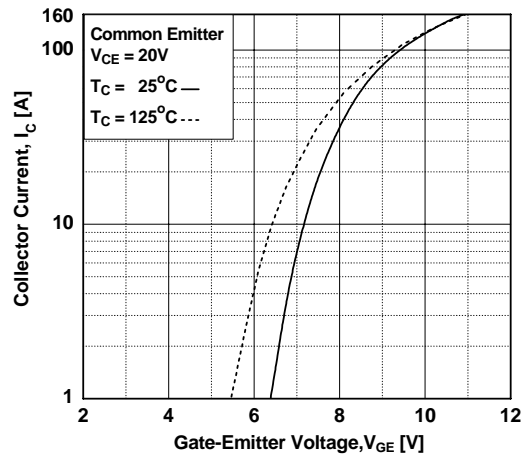


Figure 5. Saturation Voltage vs. Case Temperature at Variant Current Level

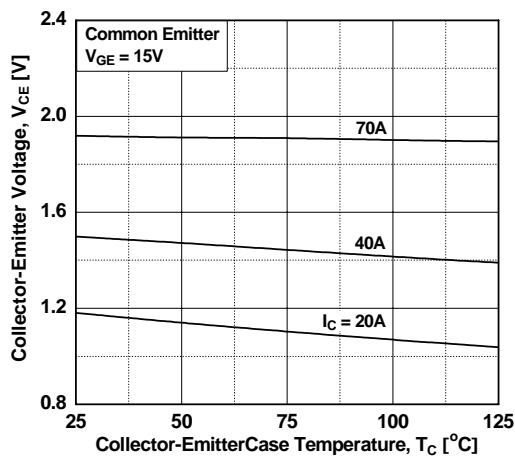
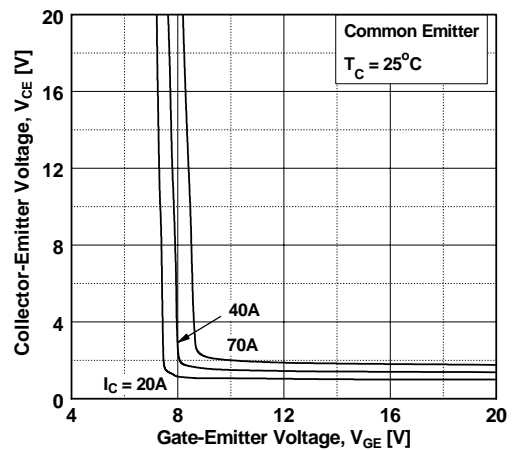
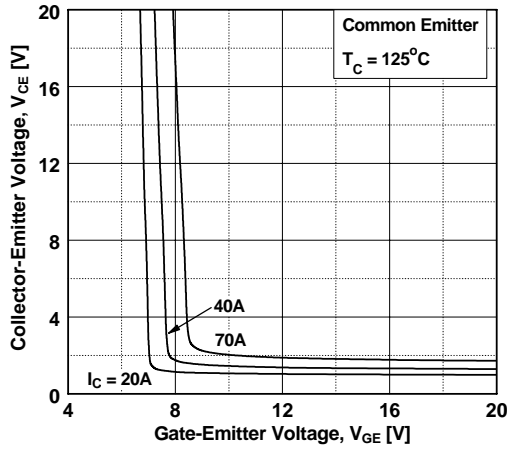


Figure 6. Saturation Voltage vs. Vge

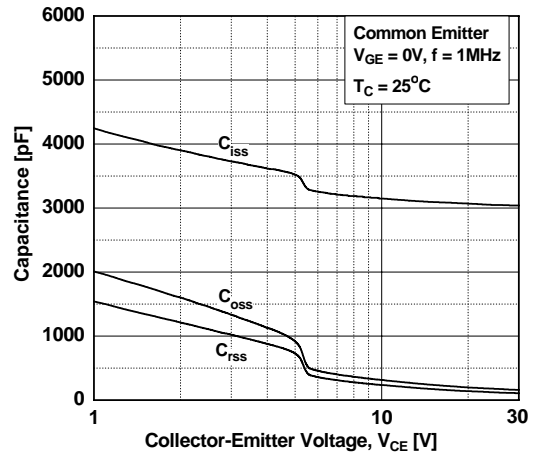


**Typical Performance Characteristics** (Continued)

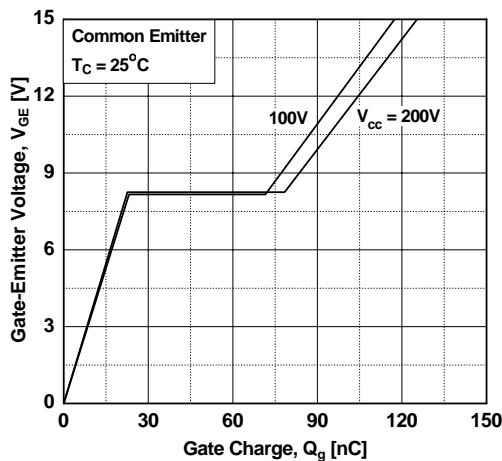
**Figure 7. Saturation Voltage vs.  $V_{GE}$**



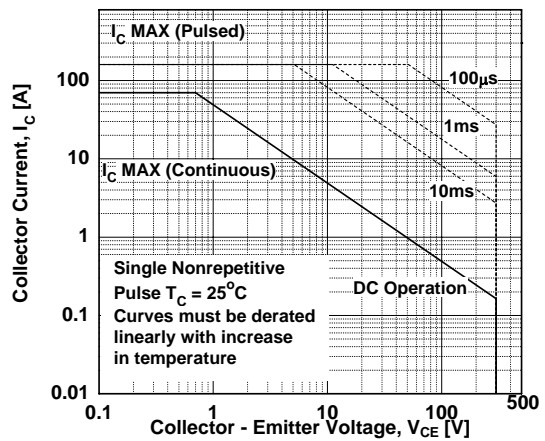
**Figure 8. Capacitance Characteristics**



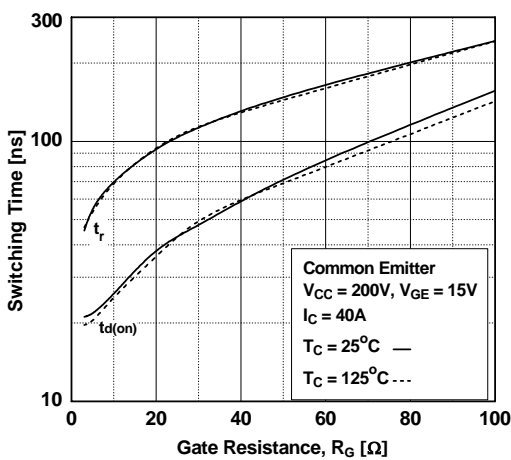
**Figure 9. Gate Charge Characteristics**



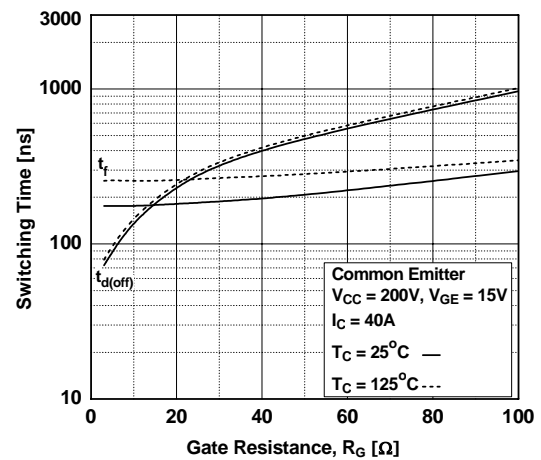
**Figure 10. SOA Characteristics**



**Figure 11. Turn-on Characteristics vs. Gate Resistance**

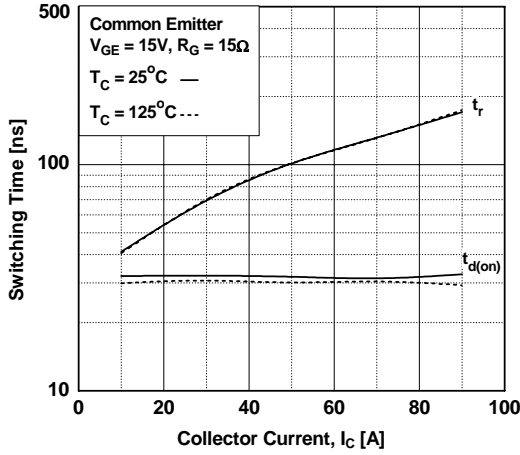


**Figure 12. Turn-off Characteristics vs. Gate Resistance**

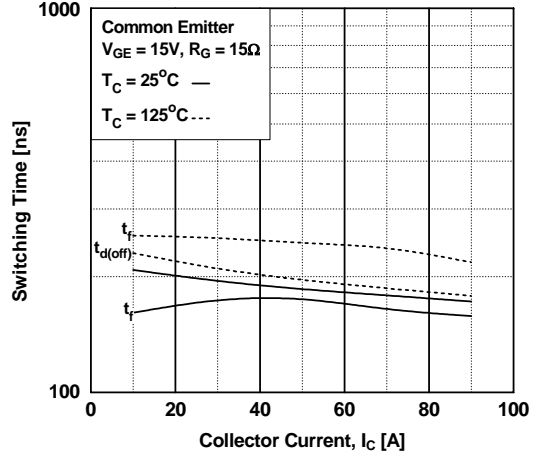


**Typical Performance Characteristics** (Continued)

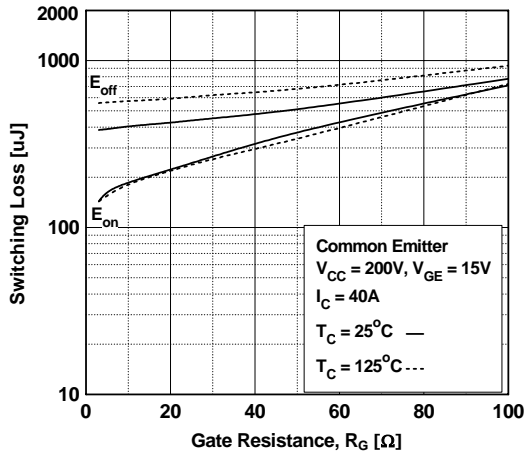
**Figure 13. Turn-on Characteristics vs. Collector Current**



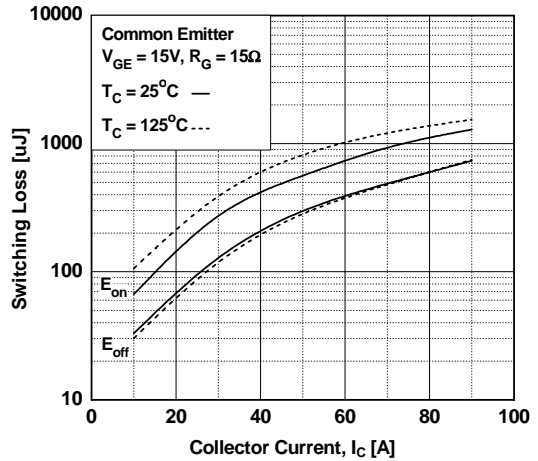
**Figure 14. Turn-off Characteristics vs. Collector Current**



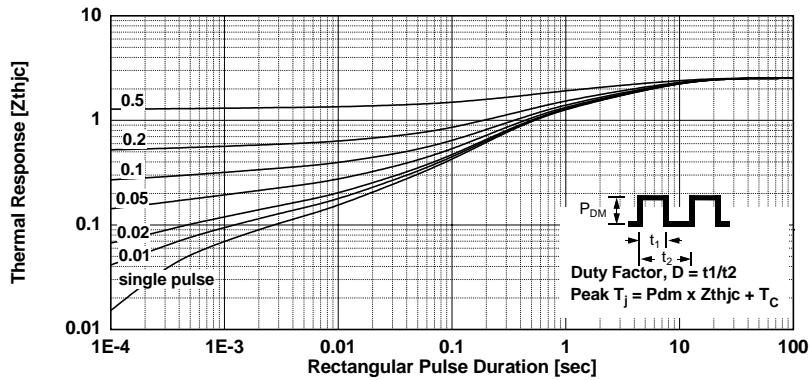
**Figure 15. Switching Loss vs. Gate Resistance**



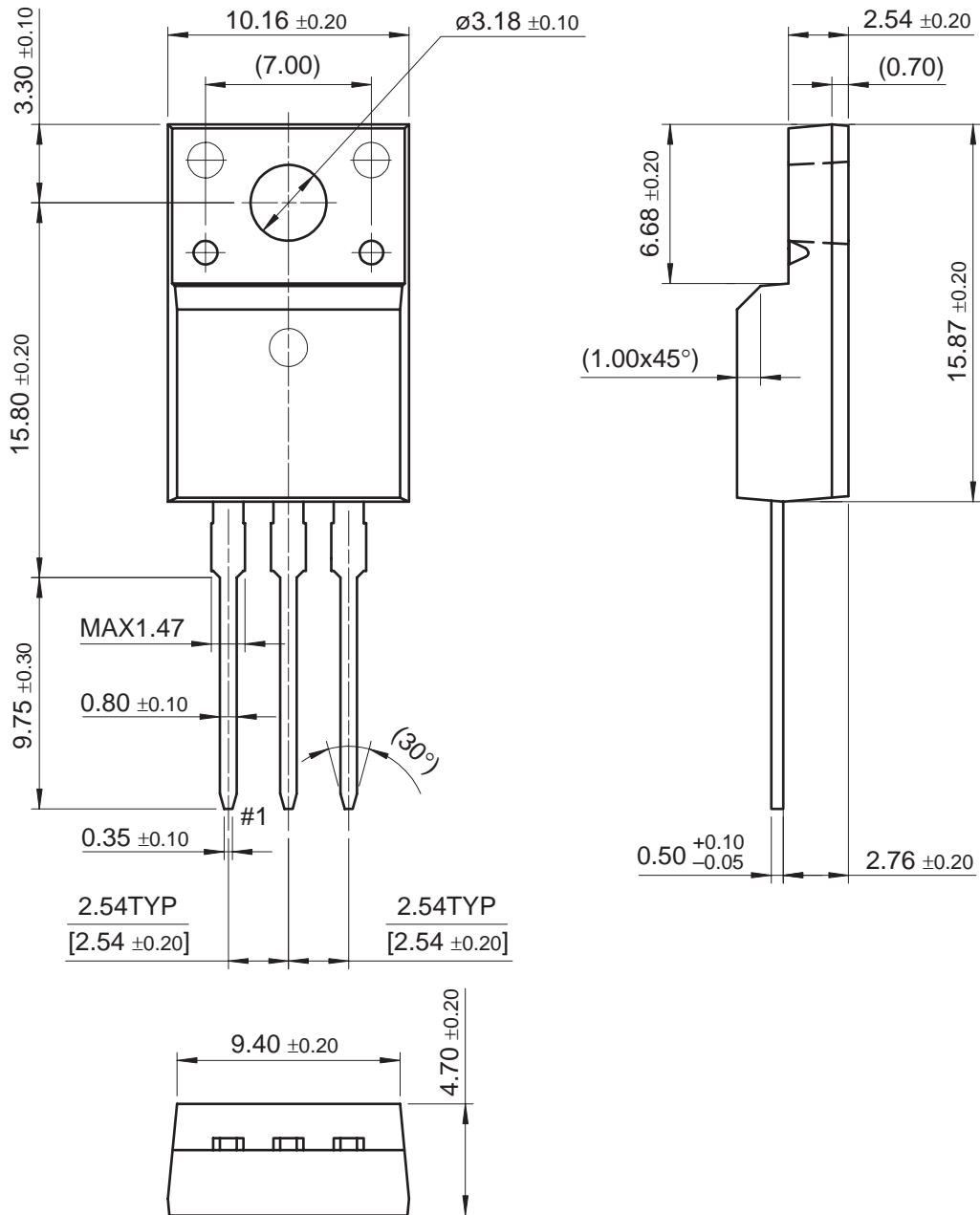
**Figure 16. Switching Loss vs. Collector Current**



**Figure 17. Transient Thermal Impedance of IGBT**




TO-220F





## TRADEMARKS

The following are registered and unregistered trademarks and service marks Fairchild Semiconductor owns or is authorized to use and is not intended to be an exhaustive list of all such trademarks.

ACE <sup>®</sup>	Green FPS <sup>™</sup> e-Series <sup>™</sup>	POWEREDGE <sup>®</sup>	SuperSOT <sup>™</sup> -8
Build it Now <sup>™</sup>	GTO <sup>™</sup>	Power-SPM <sup>™</sup>	SyncFET <sup>™</sup>
CorePLUS <sup>™</sup>	<i>i-Lo</i> <sup>™</sup>	PowerTrench <sup>®</sup>	The Power Franchise <sup>®</sup>
CROSSVOLT <sup>™</sup>	IntelliMAX <sup>™</sup>	Programmable Active Droop <sup>™</sup>	 <sup>™</sup>
CTL <sup>™</sup>	ISOPLANAR <sup>™</sup>	QFET <sup>®</sup>	TinyBoost <sup>™</sup>
Current Transfer Logic <sup>™</sup>	MegaBuck <sup>™</sup>	QS <sup>™</sup>	TinyBuck <sup>™</sup>
EcoSPARK <sup>®</sup>	MICROCOUPLER <sup>™</sup>	QT Optoelectronics <sup>™</sup>	TinyLogic <sup>®</sup>
FACT Quiet Series <sup>™</sup>	MicroFET <sup>™</sup>	Quiet Series <sup>™</sup>	TINYOPTO <sup>™</sup>
FACT <sup>®</sup>	MicroPak <sup>™</sup>	RapidConfigure <sup>™</sup>	TinyPower <sup>™</sup>
FAST <sup>®</sup>	Motion-SPM <sup>™</sup>	SMART START <sup>™</sup>	TinyPWM <sup>™</sup>
FastvCore <sup>™</sup>	OPTOLOGIC <sup>®</sup>	SPM <sup>®</sup>	TinyWire <sup>™</sup>
FPS <sup>™</sup>	OPTOPLANAR <sup>®</sup>	STEALTH <sup>™</sup>	μSerDes <sup>™</sup>
FRFET <sup>®</sup>	PDP-SPM <sup>™</sup>	SuperFET <sup>™</sup>	UHC <sup>®</sup>
Global Power Resource <sup>SM</sup>	Power220 <sup>®</sup>	SuperSOT <sup>™</sup> -3	UniFET <sup>™</sup>
Green FPS <sup>™</sup>	Power247 <sup>®</sup>	SuperSOT <sup>™</sup> -6	VCX <sup>™</sup>

## DISCLAIMER

FAIRCHILD SEMICONDUCTOR RESERVES THE RIGHT TO MAKE CHANGES WITHOUT FURTHER NOTICE TO ANY PRODUCTS HEREIN TO IMPROVE RELIABILITY, FUNCTION, OR DESIGN. FAIRCHILD DOES NOT ASSUME ANY LIABILITY ARISING OUT OF THE APPLICATION OR USE OF ANY PRODUCT OR CIRCUIT DESCRIBED HEREIN; NEITHER DOES IT CONVEY ANY LICENSE UNDER ITS PATENT RIGHTS, NOR THE RIGHTS OF OTHERS. THESE SPECIFICATIONS DO NOT EXPAND THE TERMS OF FAIRCHILD'S WORLDWIDE TERMS AND CONDITIONS, SPECIFICALLY THE WARRANTY THEREIN, WHICH COVERS THESE PRODUCTS.

## LIFE SUPPORT POLICY

FAIRCHILD'S PRODUCTS ARE NOT AUTHORIZED FOR USE AS CRITICAL COMPONENTS IN LIFE SUPPORT DEVICES OR SYSTEMS WITHOUT THE EXPRESS WRITTEN APPROVAL OF FAIRCHILD SEMICONDUCTOR CORPORATION.

As used herein:

1. Life support devices or systems are devices or systems which, (a) are intended for surgical implant into the body or (b) support or sustain life, and (c) whose failure to perform when properly used in accordance with instructions for use provided in the labeling, can be reasonably expected to result in a significant injury of the user.
2. A critical component in any component of a life support device, or system whose failure to perform can be reasonably expected to cause the failure of the life support device or system, or to affect its safety or effectiveness.

## PRODUCT STATUS DEFINITIONS

### Definition of Terms

Datasheet Identification	Product Status	Definition
Advance Information	Formative or In Design	This datasheet contains the design specifications for product development. Specifications may change in any manner without notice.
Preliminary	First Production	This datasheet contains preliminary data; supplementary data will be published at a later date. Fairchild Semiconductor reserves the right to make changes at any time without notice to improve design.
No Identification Needed	Full Production	This datasheet contains final specifications. Fairchild Semiconductor reserves the right to make changes at any time without notice to improve design.
Obsolete	Not In Production	This datasheet contains specifications on a product that has been discontinued by Fairchild Semiconductor. The datasheet is printed for reference information only.

Rev. I29