



SANYO Semiconductors

# DATA SHEET

An ON Semiconductor Company

## 2SA2016/2SC5569 — PNP / NPN Epitaxial Planar Silicon Transistor DC / DC Converter Applications

### Applications

- Relay drivers, lamp drivers, motor drivers, flash

### Features

- Adoption of FBET and MBIT processes
- Low collector-to-emitter saturation voltage
- Ultrasmall package facilitates miniaturization in end products
- High allowable power dissipation
- Large current capacity
- High-speed switching

( )2SA2016

### Specifications

Absolute Maximum Ratings at Ta=25°C

Parameter	Symbol	Conditions	Ratings	Unit
Collector-to-Base Voltage	V <sub>CB0</sub>		(-50)100	V
Collector-to-Emitter Voltage	V <sub>CES</sub>		(-50)100	V
Collector-to-Emitter Voltage	V <sub>CEO</sub>		(-)50	V
Emitter-to-Base Voltage	V <sub>EB0</sub>		(-)6	V

Continued on next page.

### Package Dimensions

unit : mm (typ)

7008B-003

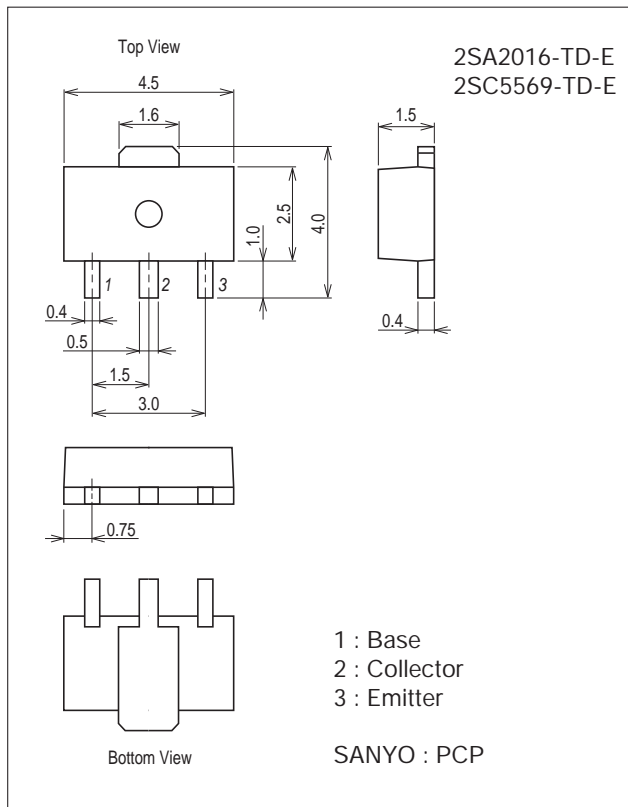

### Product & Package Information

- Package : PCP
- JEITA, JEDEC : SC-62, SOT-89, TO-243
- Minimum Packing Quantity : 1,000 pcs./reel

### Packing Type: TD

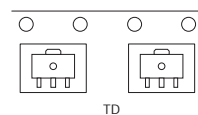

### Marking

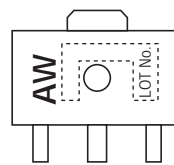

2SA2016

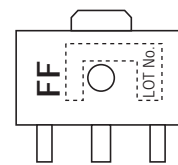

2SC5569

### Electrical Connection

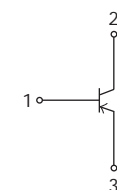

2SA2016

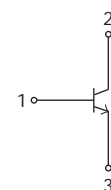

2SC5569

SANYO Semiconductor Co., Ltd.

<http://www.sanyosemi.com/en/network/>

Continued from preceding page.

Parameter	Symbol	Conditions	Ratings	Unit
Collector Current	$I_C$		(-)7	A
Collector Current (Pulse)	$I_{CP}$		(-)10	A
Base Current	$I_B$		(-)1.2	A
Collector Dissipation	$P_C$	When mounted on ceramic substrate (250mm <sup>2</sup> x0.8mm)	1.3	W
		$T_c=25^\circ\text{C}$	3.5	W
Junction Temperature	$T_J$		150	$^\circ\text{C}$
Storage Temperature	$T_{stg}$		-55 to +150	$^\circ\text{C}$

**Electrical Characteristics at  $T_a=25^\circ\text{C}$**

Parameter	Symbol	Conditions	Ratings			Unit
			min	typ	max	
Collector Cutoff Current	$I_{CBO}$	$V_{CB}=(-)40\text{V}, I_E=0\text{A}$			(-)0.1	$\mu\text{A}$
Emitter Cutoff Current	$I_{EBO}$	$V_{EB}=(-)4\text{V}, I_C=0\text{A}$			(-)0.1	$\mu\text{A}$
DC Current Gain	$h_{FE}$	$V_{CE}=(-)2\text{V}, I_C=(-)500\text{mA}$	200		560	
Gain-Bandwidth Product	$f_T$	$V_{CE}=(-)10\text{V}, I_C=(-)500\text{mA}$		(290)330		MHz
Output Capacitance	$C_{ob}$	$V_{CB}=(-)10\text{V}, f=1\text{MHz}$		(50)28		pF
Collector-to-Emitter Saturation Voltage	$V_{CE(sat)1}$	$I_C=(-)3.5\text{A}, I_B=(-)175\text{mA}$		(-230)160	(-390)240	mV
	$V_{CE(sat)2}$	$I_C=(-)2\text{A}, I_B=(-)40\text{mA}$		(-240)110	(-400)170	mV
Base-to-Emitter Saturation Voltage	$V_{BE(sat)}$	$I_C=(-)2\text{A}, I_B=(-)40\text{mA}$		(-)0.83	(-)1.2	V
Collector-to-Base Breakdown Voltage	$V_{(BR)CBO}$	$I_C=(-)10\mu\text{A}, I_E=0\text{A}$	(-50)100			V
Collector-to-Emitter Breakdown Voltage	$V_{(BR)CES}$	$I_C=(-)100\mu\text{A}, R_{BE}=0\Omega$	(-50)100			V
Collector-to-Emitter Breakdown Voltage	$V_{(BR)CEO}$	$I_C=(-)1\text{mA}, R_{BE}=\infty$	(-)50			V
Emitter-to-Base Breakdown Voltage	$V_{(BR)EBO}$	$I_E=(-)10\mu\text{A}, I_C=0\text{A}$	(-)6			V
Turn-On Time	$t_{on}$	See specified Test Circuit.		(40)30		ns
Storage Time	$t_{stg}$			(225)420		ns
Fall Time	$t_f$			25		ns

**Switching Time Test Circuit**

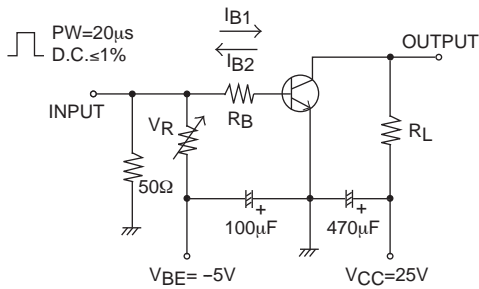

$I_C=20I_{B1} = -20I_{B2}=2.5\text{A}$

For PNP, the polarity is reversed.

**Ordering Information**

Device	Package	Shipping	memo
2SA2016-TD-E	PCP	1,000pcs./reel	Pb Free
2SC5569-TD-E	PCP	1,000pcs./reel	

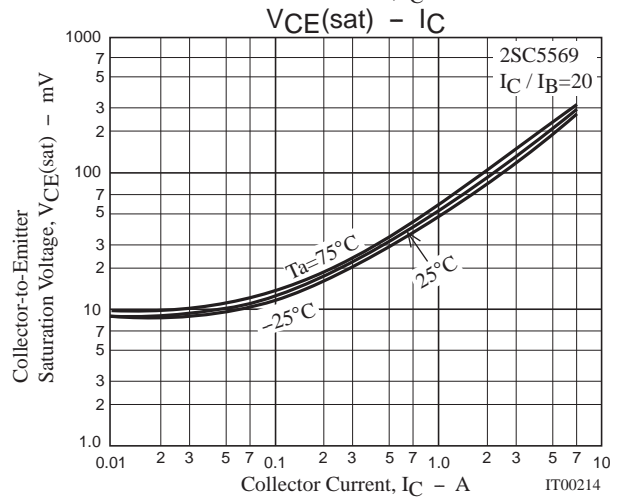
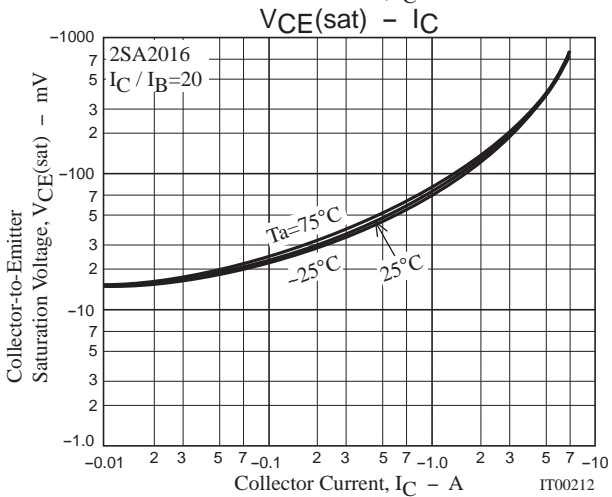
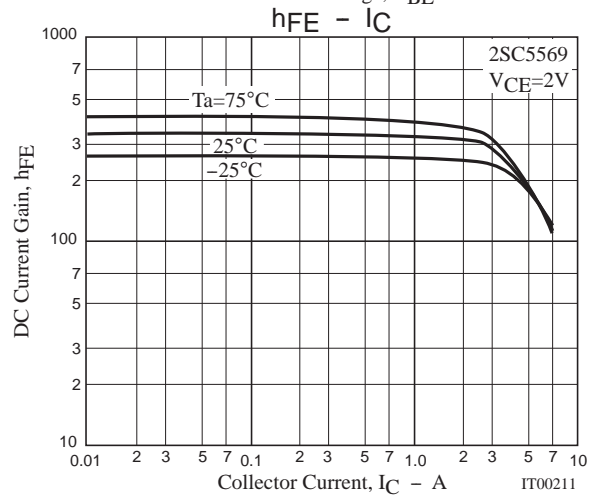
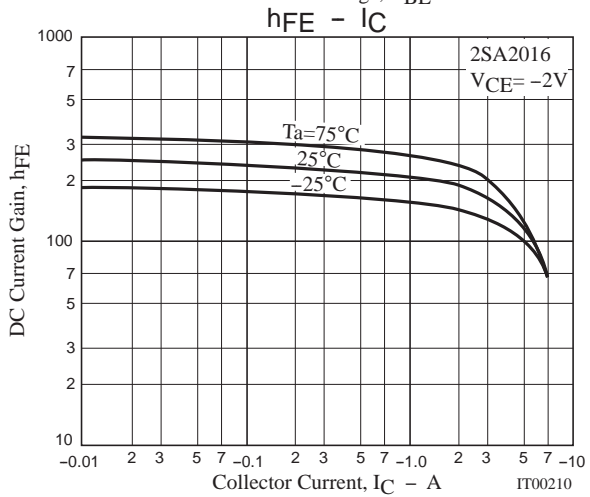
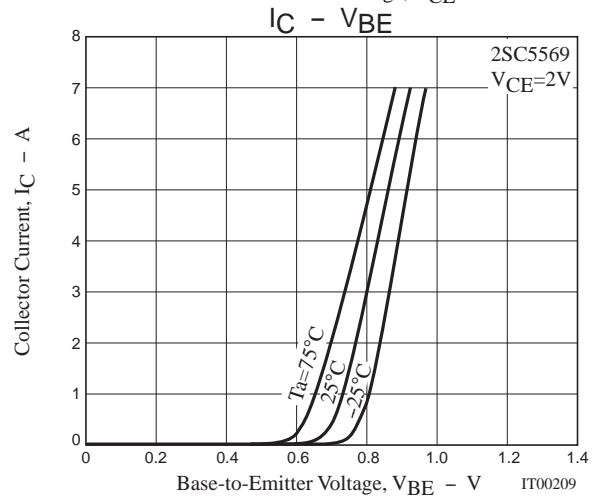
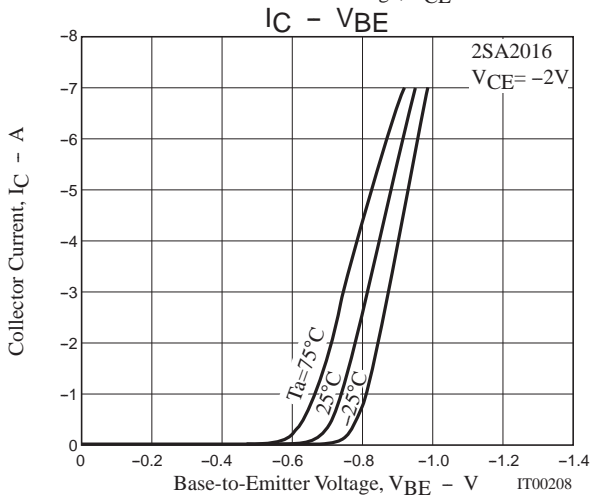
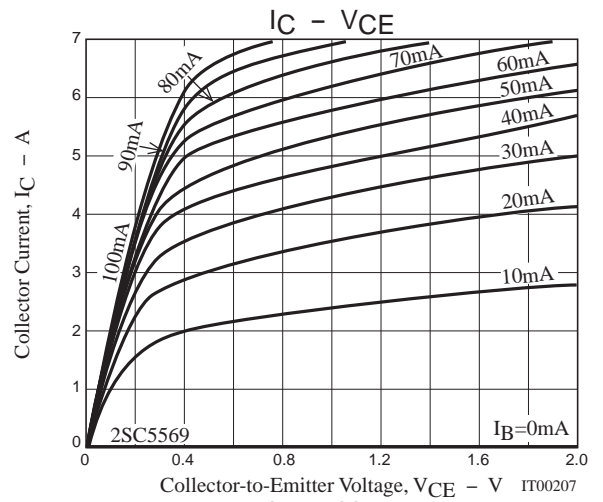
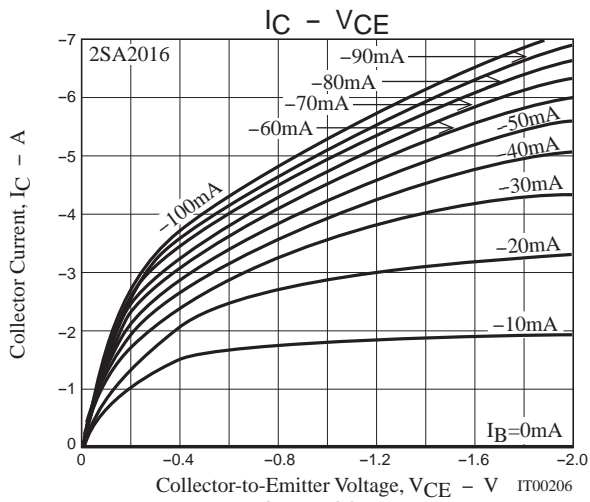

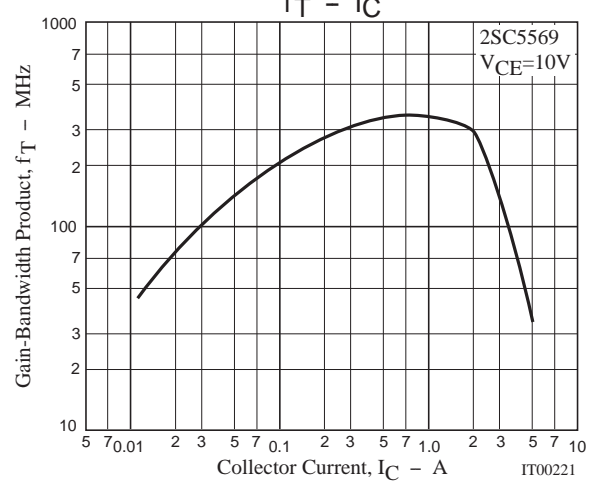
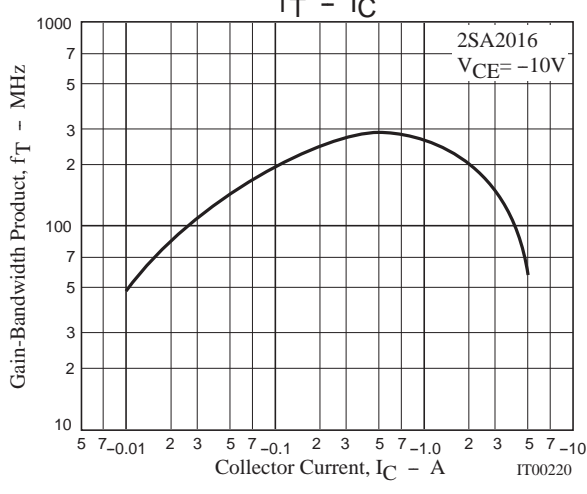
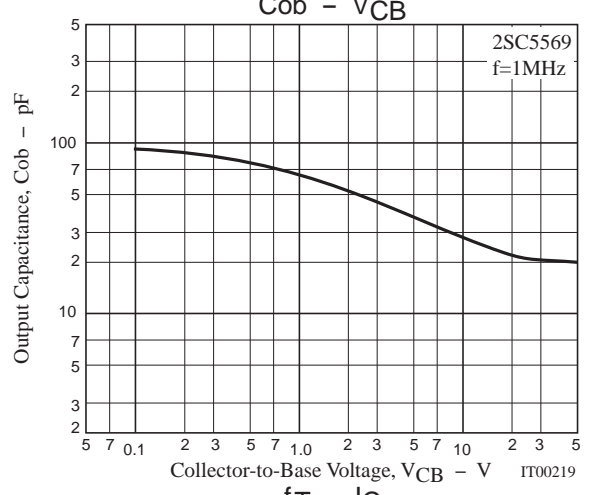
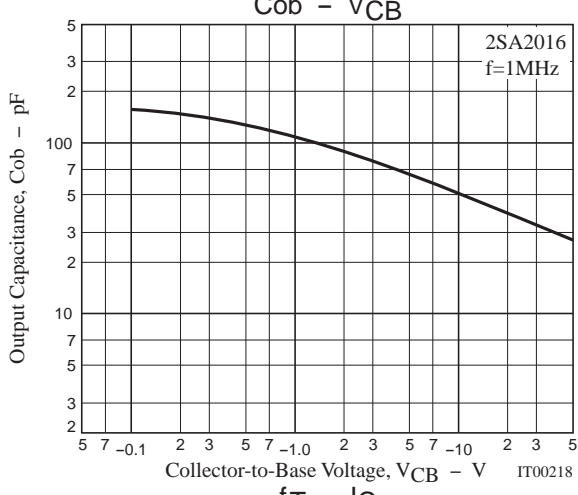
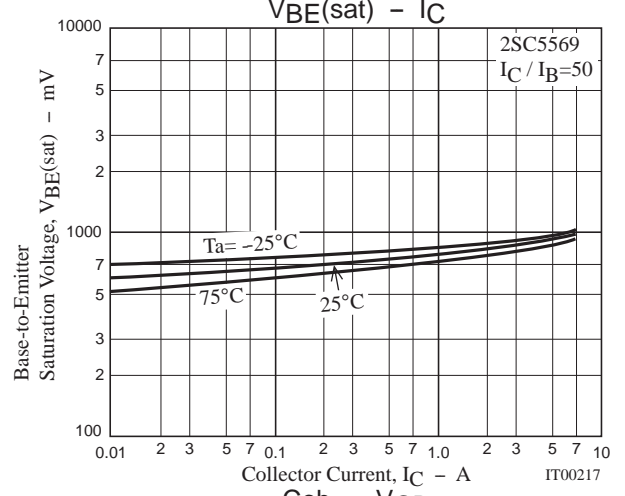
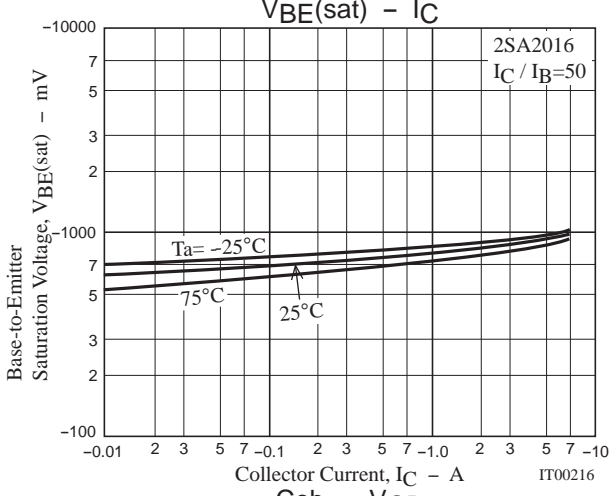
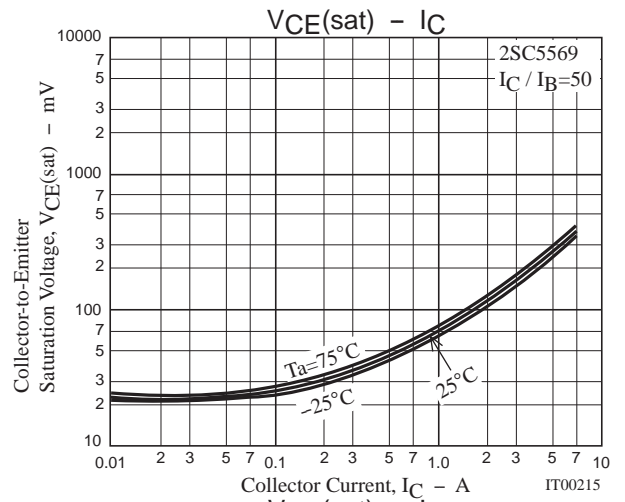
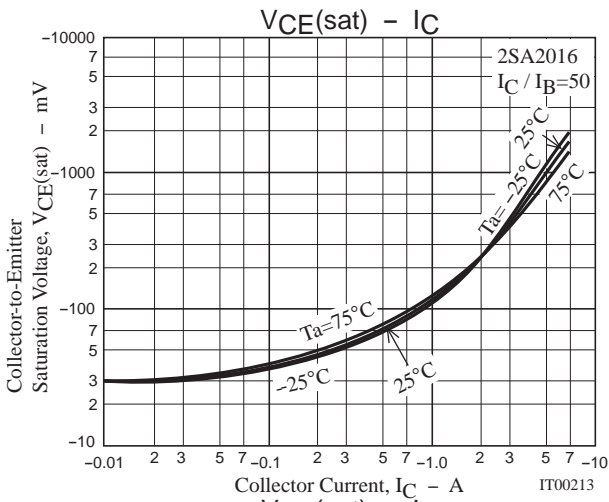

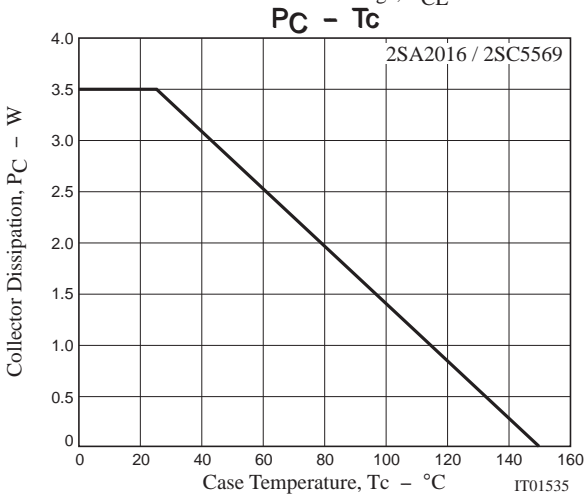
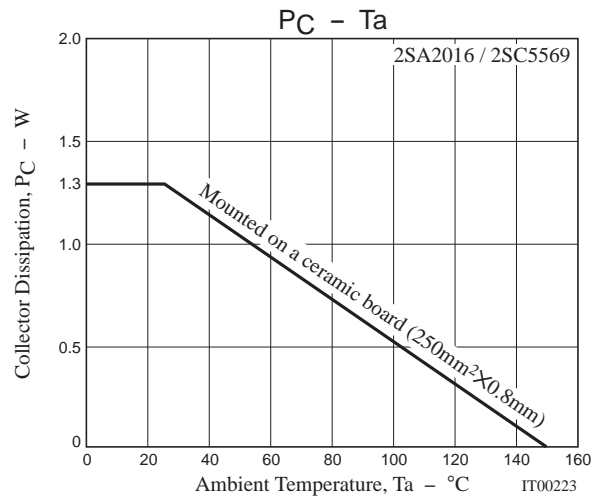
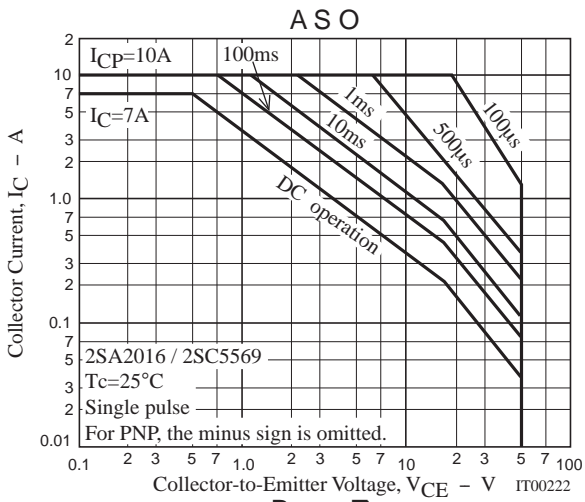

Bag Packing Specification

2SA2016-TD-E, 2SC5569-TD-E

1. Packing Format

Package Name	Carrier Tape Type	Maximum Number of devices contained (pcs)			Packing format	
		Reel	Inner box	Outer box	Inner BOX (C-1)	Outer BOX (A-7)
PCP	PCP	1,000	4,000	24,000	4 reels contained Dimensions:mm (external) 183×72×185	6 inner boxes contained Dimensions:mm (external) 440×195×210

Reel label, Inner box label  
(unit : mm)

Outer box label  
It is a label at the time of factory shipments.  
The form of a label may change in physical distribution process.

Packing method

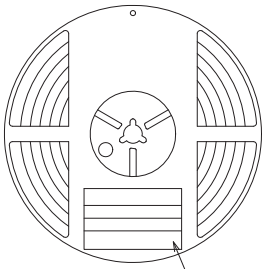

Type No.  
LOT No.  
Quantity  
Origin

Reel label

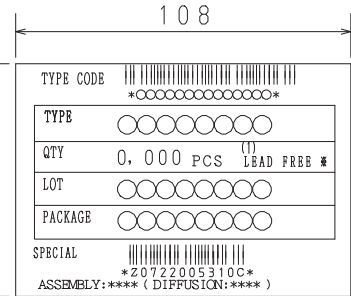
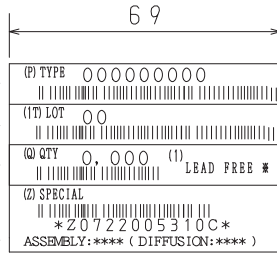

NOTE (1)

The LEAD FREE \* description shows that the surface treatment of the terminal is lead free.

Label	JEITA Phase
LEAD FREE 3	JEITA Phase 3A
LEAD FREE 4	JEITA Phase 3

2. Taping configuration

2-1. Carrier tape size (unit:mm)

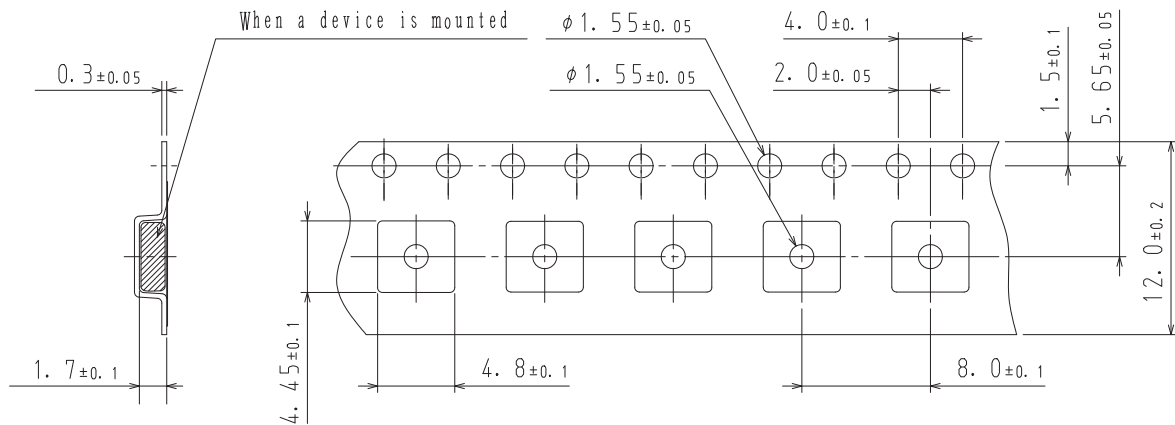

2-2. Device placement direction



Those with pin 1 index on the feed hole side.....TD

Outline Drawing

2SA2016-TD-E, 2SC5569-TD-E

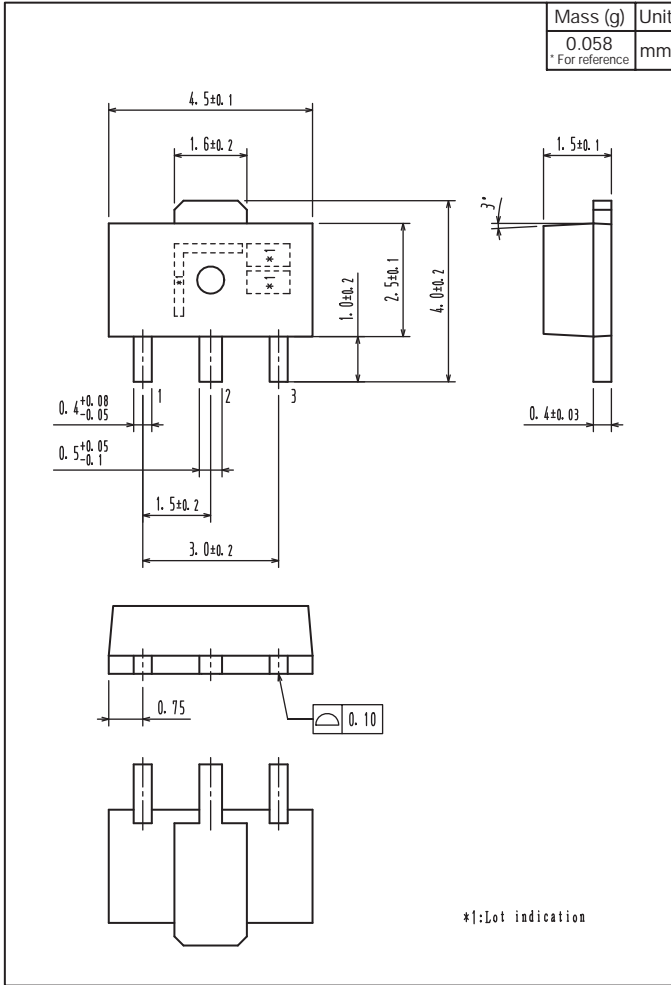

Land Pattern Example

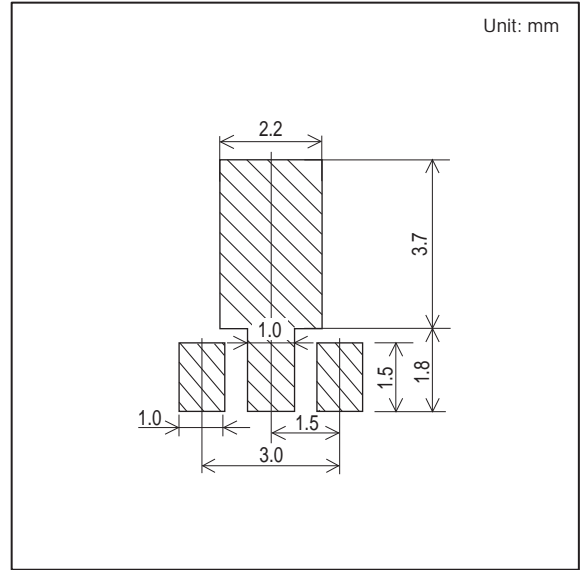

- Any and all SANYO Semiconductor Co.,Ltd. products described or contained herein are, with regard to "standard application", intended for the use as general electronics equipment. The products mentioned herein shall not be intended for use for any "special application" (medical equipment whose purpose is to sustain life, aerospace instrument, nuclear control device, burning appliances, transportation machine, traffic signal system, safety equipment etc.) that shall require extremely high level of reliability and can directly threaten human lives in case of failure or malfunction of the product or may cause harm to human bodies, nor shall they grant any guarantee thereof. If you should intend to use our products for new introduction or other application different from current conditions on the usage of automotive device, communication device, office equipment, industrial equipment etc. , please consult with us about usage condition (temperature, operation time etc.) prior to the intended use. If there is no consultation or inquiry before the intended use, our customer shall be solely responsible for the use.
- Specifications of any and all SANYO Semiconductor Co.,Ltd. products described or contained herein stipulate the performance, characteristics, and functions of the described products in the independent state, and are not guarantees of the performance, characteristics, and functions of the described products as mounted in the customer's products or equipment. To verify symptoms and states that cannot be evaluated in an independent device, the customer should always evaluate and test devices mounted in the customer's products or equipment.
- SANYO Semiconductor Co.,Ltd. assumes no responsibility for equipment failures that result from using products at values that exceed, even momentarily, rated values (such as maximum ratings, operating condition ranges, or other parameters) listed in products specifications of any and all SANYO Semiconductor Co.,Ltd. products described or contained herein.
- Regarding monolithic semiconductors, if you should intend to use this IC continuously under high temperature, high current, high voltage, or drastic temperature change, even if it is used within the range of absolute maximum ratings or operating conditions, there is a possibility of decrease reliability. Please contact us for a confirmation.
- SANYO Semiconductor Co.,Ltd. strives to supply high-quality high-reliability products, however, any and all semiconductor products fail or malfunction with some probability. It is possible that these probabilistic failures or malfunction could give rise to accidents or events that could endanger human lives, trouble that could give rise to smoke or fire, or accidents that could cause damage to other property. When designing equipment, adopt safety measures so that these kinds of accidents or events cannot occur. Such measures include but are not limited to protective circuits and error prevention circuits for safe design, redundant design, and structural design.
- In the event that any or all SANYO Semiconductor Co.,Ltd. products described or contained herein are controlled under any of applicable local export control laws and regulations, such products may require the export license from the authorities concerned in accordance with the above law.
- No part of this publication may be reproduced or transmitted in any form or by any means, electronic or mechanical, including photocopying and recording, or any information storage or retrieval system, or otherwise, without the prior written consent of SANYO Semiconductor Co.,Ltd.
- Any and all information described or contained herein are subject to change without notice due to product/technology improvement, etc. When designing equipment, refer to the "Delivery Specification" for the SANYO Semiconductor Co.,Ltd. product that you intend to use.
- Upon using the technical information or products described herein, neither warranty nor license shall be granted with regard to intellectual property rights or any other rights of SANYO Semiconductor Co.,Ltd. or any third party. SANYO Semiconductor Co.,Ltd. shall not be liable for any claim or suits with regard to a third party's intellectual property rights which has resulted from the use of the technical information and products mentioned above.

This catalog provides information as of January, 2013. Specifications and information herein are subject to change without notice.