

7-57-11

NEW

Z SERIES DC-DC CONVERTER

ZS10 10W Single Output

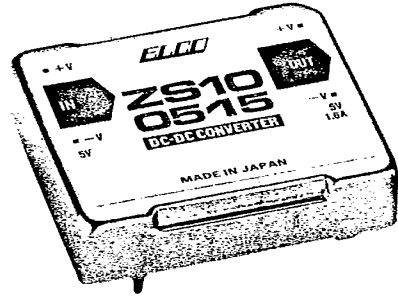
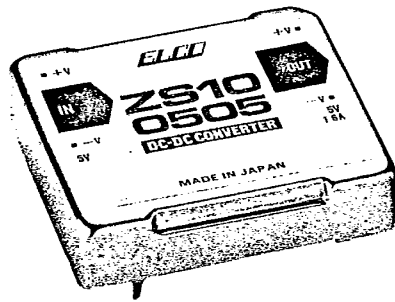

Z Series DC-DC Converter. Designed for Small Size and High Reliability.

- Isolated Output.
- Over Current Protection.
- Small, Compact size.

■ ORDERING INFORMATION

ZS100512

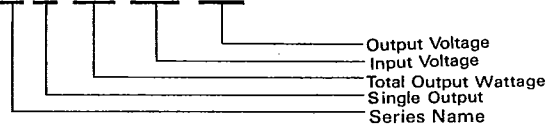

SPECIFICATIONS

型名	MODEL	ZS100505	ZS100512	ZS100515	ZS101205	ZS101212	ZS101215	ZS102405	ZS102412	ZS102415	
INPUT	VOLTAGE (V)	5 (4.5~6.0)			12 (10~15)			24 (20~30)			
	EFFICIENCY (%)	72 typ			80 typ			80 typ			
OUTPUT	VOLTAGE (V)	5	12	15	5	12	15	5	12	15	
	CURRENT (A)	1.6	0.7	0.6	2.0	0.9	0.7	2.0	0.9	0.7	
	REGULATION LINE (mV)	25max	60max	75max	25max	60max	75max	25max	60max	75max	
	REGULATION LOAD (mV)	50max	120max	150max	50max	120max	150max	50max	120max	150max	
	RIPPLE (mVp-p)	100max	120max	120max	100max	120max	120max	100max	120max	120max	
	RIPPLE NOISE (mVp-p)	120max	120max	120max	120max	120max	120max	120max	120max	120max	120max
PROTECTION CIRCUIT	TEMPERATURE (mV) DRIFT (0~+55°C)	50max	120max	150max	50max	120max	150max	50max	120max	150max	
	OUTPUT VOLTAGE SETTING (%)	±5max									
ELECTRICALLY ISOLATED	OVER CURRENT PROTECTION	Works at over 105% of rating and recovers automatically									
	HIGH POT.	Input-Output, Input-Case, Output-Case AC500V 1minute(At room Temperature and Humidity)									
ENVIRONMENT	ISOLATION	Input-Output, Input-Case, Output-Case DC500V 50MΩ(At room Temperature and Humidity)									
	OPERATING TEMP. AND HUMID.	0~+55°C, 20~90%RH(Non condensing)									
	STORAGE TEMP. AND HUMID.	-20~+75°C, 20~90%RH(Non condensing)									
	VIBRATION	10~55Hz at 2G 3minutes period 30minutes along X, Y and Zaxis									
	IMPACT	50G for 11ms, once on each X, Y, Zaxis									

*No parallel operation is permitted.

ZS10



EXTERNAL VIEW

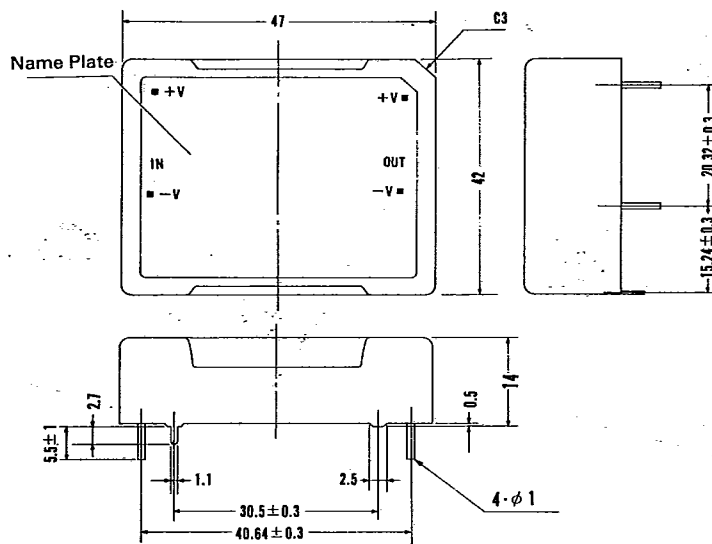

* Weight: 75g or less.
 * Tolerance: ± 1.0
 * Dimension in mm.

STATIC CHARACTERISTICS

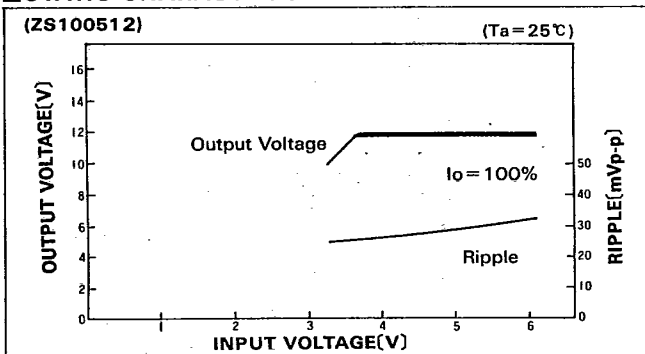

RISE TIME & FALL TIME

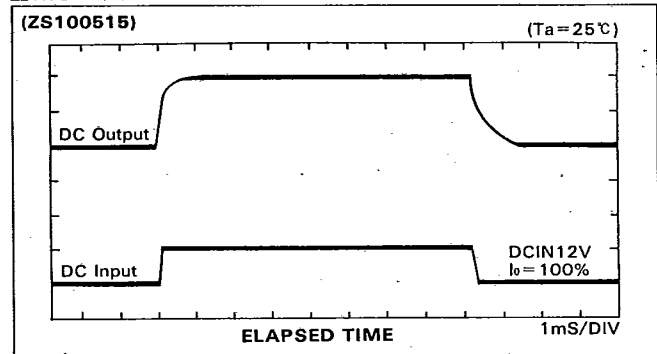

OUTPUT CURRENT V.S. OUTPUT VOLTAGE

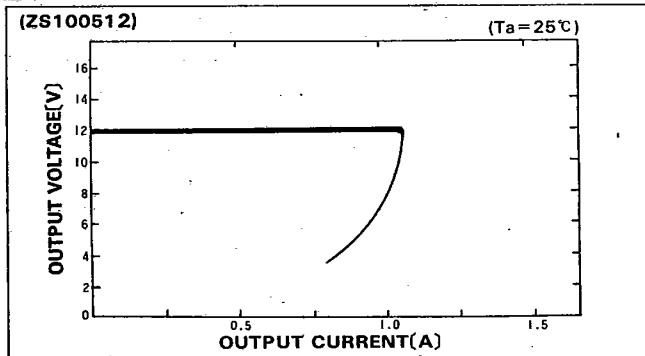

POWER DERATING CURVE

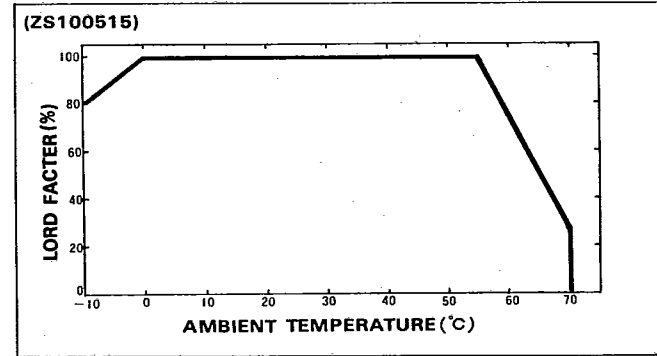

* Z series switching power supplies are warranted for one year period.
 * All the above specifications are subject to change without notice.