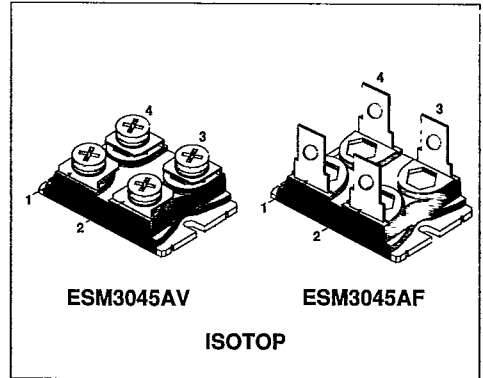
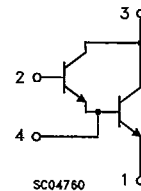

NPN DARLINGTON POWER MODULE

- HIGH CURRENT POWER BIPOLAR MODULE
- VERY LOW R_{th} JUNCTION CASE
- SPECIFIED ACCIDENTAL OVERLOAD AREAS
- ISOLATED CASE (2500V RMS)
- EASY TO MOUNT
- LOW INTERNAL PARASITIC INDUCTANCE

INDUSTRIAL APPLICATIONS:

- MOTOR CONTROL
- SMPS & UPS
- WELDING EQUIPMENT

INTERNAL SCHEMATIC DIAGRAM

ABSOLUTE MAXIMUM RATINGS

Symbol	Parameter	Value	Unit
V_{CEV}	Collector-Emitter Voltage ($V_{BE} = -5$ V)	1000	V
$V_{CEO(sus)}$	Collector-Emitter Voltage ($I_B = 0$)	450	V
V_{EBO}	Emitter-Base Voltage ($I_C = 0$)	7	V
I_C	Collector Current	22	A
I_{CM}	Collector Peak Current ($t_p = 10$ ms)	33	A
I_B	Base Current	2.5	A
I_{BM}	Base Peak Current ($t_p = 10$ ms)	5	A
P_{tot}	Total Dissipation at $T_c = 25$ °C	125	W
T_{stg}	Storage Temperature	-55 to 150	°C
T_J	Max. Operating Junction Temperature	150	°C
V_{iso}	Insulation Withstand Voltage (AC-RMS)	2500	V

THERMAL DATA

$R_{thj-case}$	Thermal Resistance Junction-case	Max	1	°C/W
R_{thc-h}	Thermal Resistance Case-heatsink With Conductive Grease Applied	Max	0.05	°C/W

ELECTRICAL CHARACTERISTICS ($T_{case} = 25\text{ °C}$ unless otherwise specified)

T-33-35

Symbol	Parameter	Test Conditions	Min.	Typ.	Max.	Unit
$I_{cER}\#$	Collector Cut-off Current ($R_{BE} = 5\ \Omega$)	$V_{CE} = V_{CEV}$ $V_{CE} = V_{CEV}$ $T_j = 100\text{ °C}$			1.5 17	 mA mA
$I_{cEV}\#$	Collector Cut-off Current ($V_{BE} = -5$)	$V_{CE} = V_{CEV}$ $V_{CE} = V_{CEV}$ $T_j = 100\text{ °C}$			1 12	 mA mA
$I_{EBO}\#$	Emitter Cut-off Current ($I_C = 0$)	$V_{EB} = 5\text{ V}$			1	mA
$V_{CEO(SUS)}^*$	Collector-Emitter Sustaining Voltage	$I_C = 0.2\text{ A}$ $L = 25\text{ mH}$ $V_{clamp} = 450\text{ V}$	450			V
h_{FE}^*	DC Current Gain	$I_C = 18\text{ A}$ $V_{CE} = 5\text{ V}$		120		
$V_{CE(sat)}^*$	Collector-Emitter Saturation Voltage	$I_C = 15\text{ A}$ $I_B = 0.3\text{ A}$ $I_C = 15\text{ A}$ $I_B = 0.3\text{ A}$ $T_j = 100\text{ °C}$ $I_C = 18\text{ A}$ $I_B = 0.72\text{ A}$ $I_C = 18\text{ A}$ $I_B = 0.72\text{ A}$ $T_j = 100\text{ °C}$		1.2 1.3 1.3 1.45	2	 V V V V
$V_{BE(sat)}^*$	Base-Emitter Saturation Voltage	$I_C = 18\text{ A}$ $I_B = 0.72\text{ A}$ $I_C = 18\text{ A}$ $I_B = 0.72\text{ A}$ $T_j = 100\text{ °C}$		2 2	2.5	 V V
di_C/dt	Rate of Rise of On-state Collector	$V_{CC} = 300\text{ V}$ $R_C = 0$ $t_p = 3\ \mu s$ $I_{B1} = 1.08\text{ A}$ $T_j = 100\text{ °C}$	150	200		A/ μs
$V_{CE(3\ \mu s)}$	Collector-Emitter Dynamic Voltage	$V_{CC} = 300\text{ V}$ $R_C = 16.6\ \Omega$ $I_{B1} = 1.08\text{ A}$ $T_j = 100\text{ °C}$		4	7	V
$V_{CE(5\ \mu s)}$	Collector-Emitter Dynamic Voltage	$V_{CC} = 300\text{ V}$ $R_C = 16.6\ \Omega$ $I_{B1} = 1.08\text{ A}$ $T_j = 100\text{ °C}$		2.5	4	V
t_s	Storage Time	$I_C = 18\text{ A}$ $V_{CC} = 50\text{ V}$		2.5	4.5	μs
t_f	Fall Time	$V_{BB} = -5\text{ V}$ $R_{BB} = 0.6\ \Omega$		0.2	0.5	μs
t_c	Cross-over Time	$V_{olamp} = 450\text{ V}$ $I_{B1} = 0.72\text{ A}$ $L = 0.14\text{ mH}$ $T_j = 100\text{ °C}$		0.7	1.5	μs
V_{CEW}	Maximum Collector Emitter Voltage Without Snubber	$I_{Coff} = 22\text{ A}$ $I_{B1} = 0.72\text{ A}$ $V_{BB} = -5\text{ V}$ $V_{CC} = 50\text{ V}$ $L = 0.1\text{ mH}$ $R_{BB} = 0.6\ \Omega$ $T_j = 125\text{ °C}$	450			V

* Pulsed: Pulse duration = 300 μs , duty cycle 1.5 %

See test circuit in databook introduction

Safe Operating Areas

Thermal Impedance

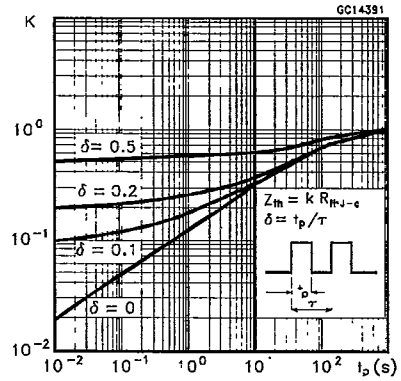
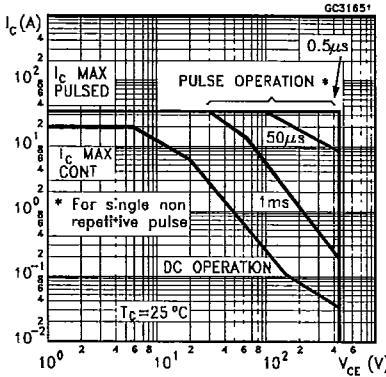

Derating Curve

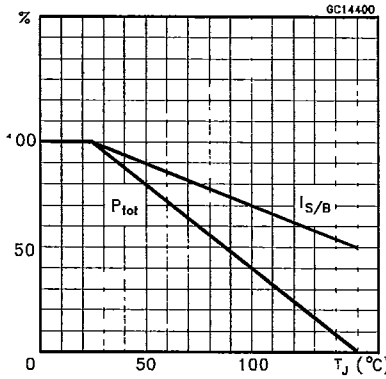

Collector-Emitter Voltage Versus Base-Emitter Resistance

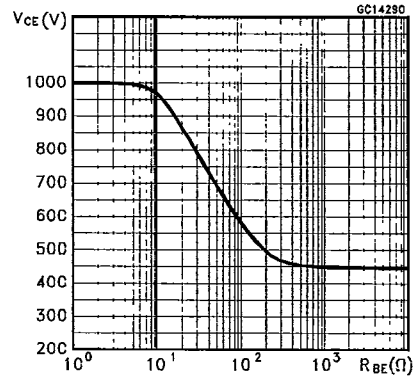

Collector-Emitter Saturation Voltage

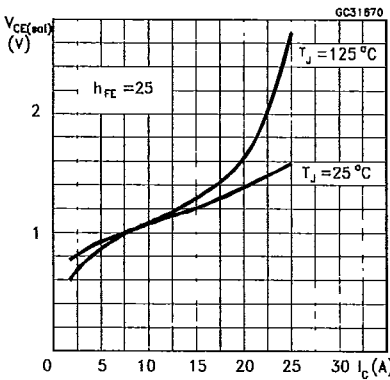

Base-Emitter Saturation Voltage

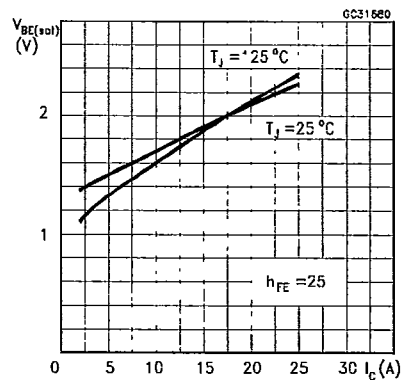

Reverse Biased SOA

Forward Biased SOA

T-33-35

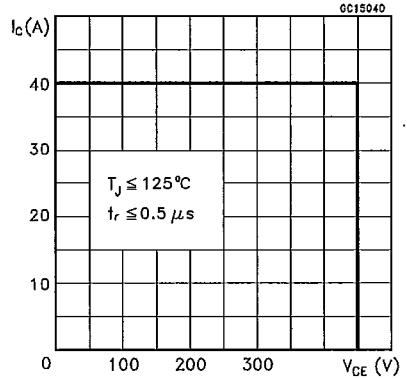
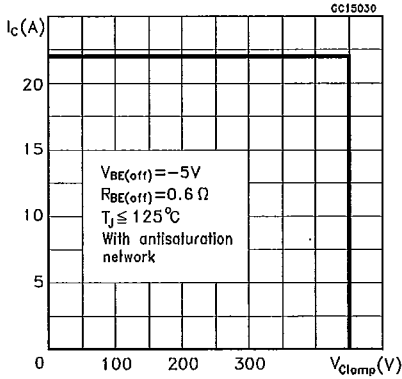

Reverse Biased AOA

Forward Biased AOA

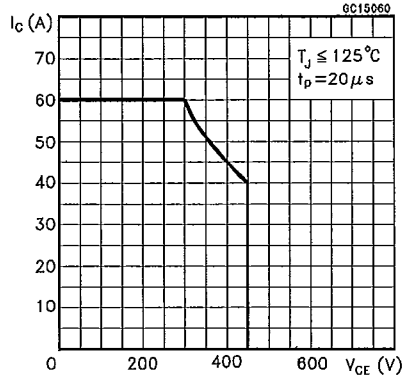
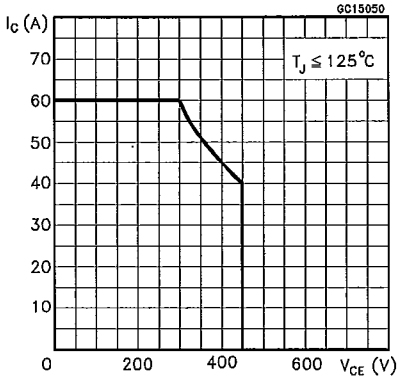

Switching Times Inductive Load

Switching Times Inductive Load Versus Temperature

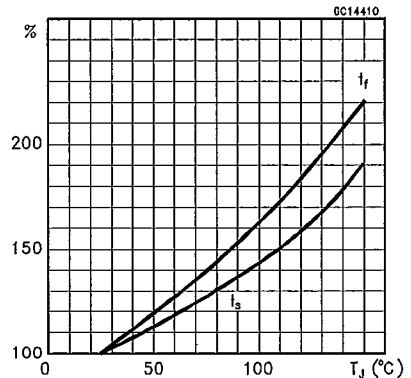
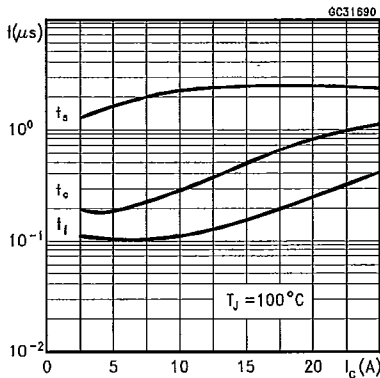

SGS-THOMSON

DC Current Gain

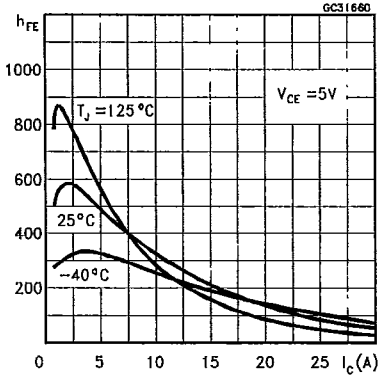

Turn-on Switching Test Circuit

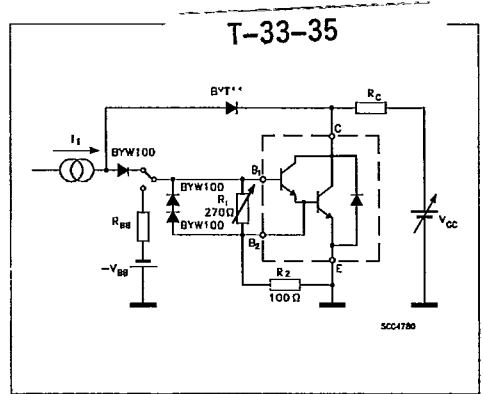

Turn-on Switching Waveforms

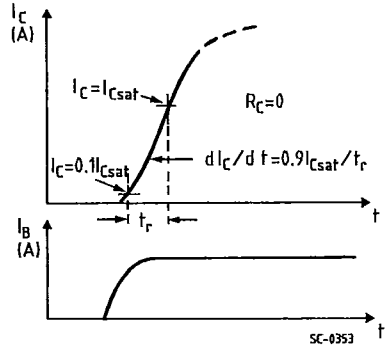
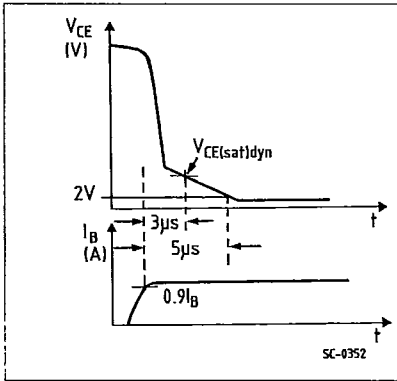

Turn-off Switching Test Circuit

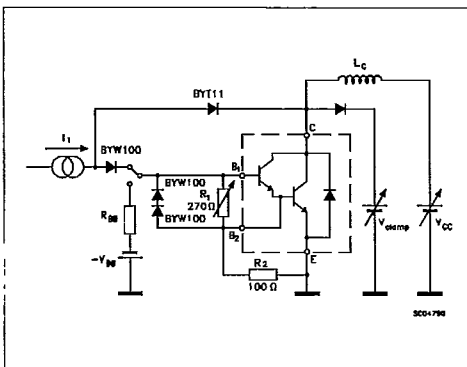

Turn-off Switching Waveforms

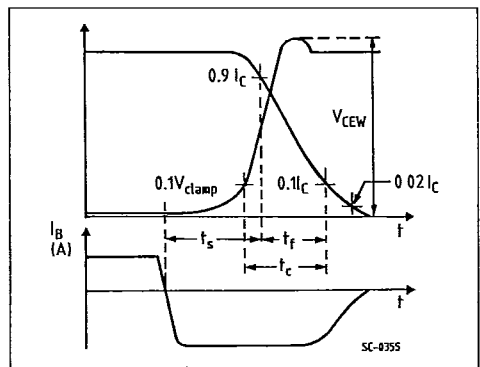

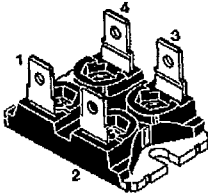

ISOTOP
Fast-on version
 sales types with the suffix F

MECHANICAL DATA

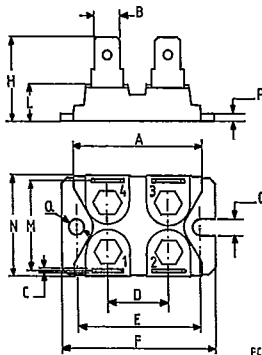

FC-9309

	DIMENSIONS			
	mm		Inches	
	min.	max	min.	max
A	31.5	31.7	1.240	1.248
B	6.2	6.4	0.244	0.252
C	0.75	0.85	0.029	0.033
D	14.9	15.1	0.586	0.590
E	30.1	30.3	1.185	1.193
F	38	38.2	1.496	1.503
G	4	-	0.157	-
H	20.3	20.7	0.799	0.815
L	8.9	9.1	0.350	0.358
M	22.4	23	0.881	0.905
N	25.2	25.4	0.992	1.000
P	1.95	2.05	0.076	0.080
Q	4	-	0.157	-

PIN CONNECTIONS

MOSFET

pin 1: Source pin 2: Gate
 pin 3: Drain pin 4: Source sensings

DARLINGTON

pin 1: Emitter pin 2: Base1
 pin 3: Collector pin 4: Base 2

TRANSISTOR

pin 1: Emitter pin 2: Base
 pin 3: Collector pin 4: Emitter sensing

Torque: Mounting $1.3 \pm 0.2 \text{ N} \cdot \text{m}$ (max)

Weight: Package 25.5 g

Note: The mechanical data are the same for the 3 pin version (4th pin missing)

S G S-THOMSON

T-91-20

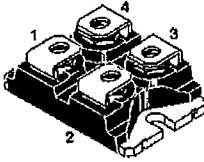

ISOTOP
Screw version
sales types with the suffix V

MECHANICAL DATA

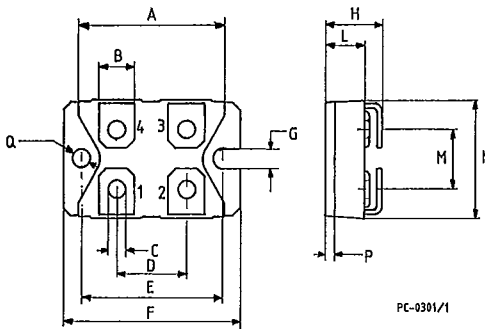

	DIMENSIONS			
	mm		Inches	
	min.	max	min.	max
A	31.5	31.7	1.240	1.248
B	7.8	8.2	0.307	0.322
C	4.1	4.3	0.161	0.169
D	14.9	15.1	0.586	0.590
E	30.1	30.3	1.185	1.193
F	38	38.2	1.496	1.503
G	4	-	0.157	-
H	11.8	12.2	0.464	0.480
L	8.9	9.1	0.350	0.358
M	12.6	12.8	0.496	0.503
N	25.2	25.4	0.992	1.000
P	1.95	2.05	0.076	0.080
Q	4	-	0.157	-

PIN CONNECTIONS

MOSFET

pin 1: Source pin 2: Gate
pin 3: Drain pin 4: Source sensings

DARLINGTON

pin 1: Emitter pin 2: Base1
pin 3: Collector pin 4: Base 2

TRANSISTOR

pin 1: Emitter pin 2: Base
pin 3: Collector pin 4: Emitter sensing

Torque: Terminal $1.3 \pm 0.2 \text{ N} \cdot \text{m}$ (max)
Mounting $1.3 \pm 0.2 \text{ N} \cdot \text{m}$ (max)

Weight: Package 29 g
4 Screws: 7,5 g

Note: The mechanical data are the same for the 3 pin version
(4th pin missing)

SGS-THOMSON

T-91-20

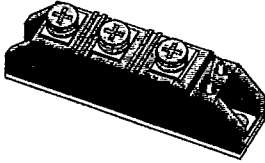

TRANSPACK (TO-240)

MECHANICAL DATA

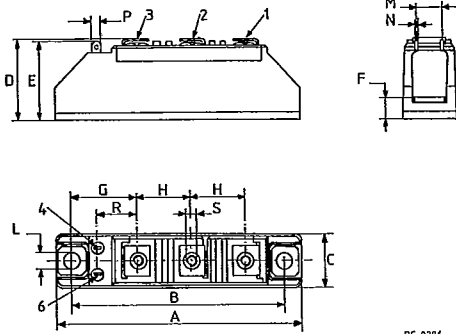

PC-0236

	DIMENSIONS			
	mm		Inches	
	min.	max	min.	max
A	91.5	92.5	3.602	3.641
B	79.75	80.25	3.140	3.160
C	19.5	20.55	0.767	0.809
D	29.00	31.00	1.141	1.220
E	28.8	30	1.134	1.181
F	8.5 typ.		0.334 typ.	
G	24.4 typ.		0.960 typ.	
H	19.5	20.5	0.767	0.807
L	6.2 typ.		0.244 typ.	
M	8.95	11.05	0.352	0.435
N	0.78	0.84	0.030	0.033
P	2.72	2.87	0.107	0.113
R	14	-	0.551	-
S	M5			

Torque: Terminal $2.2 \pm 0.5 \text{ N} \cdot \text{m}$ (max)
 Mounting $3.5 \pm 0.5 \text{ N} \cdot \text{m}$ (max)

Weight: Package 110 g
 Accessory 21 g

Note: The mechanical data are the same for the 2 power pin version (either pin 1 or pin 2 missing)