



FEATURES

- **SMALL SIZE AND LOW PROFILE :**
L X W X H = 0.60" X 0.46" X 0.30"
- **HIGH EFFICIENCY UP TO 95.5%**
- **LOW QUIESCENT CURRENT**
- **WIDE INPUT RANGE: 4.6 ~ 36VDC AND 3 ~ 5.5VDC**
- **ADJUSTABLE OUTPUT VLOTAGE**
- **OVER-CURRENT PROTECTION**
- **OUTPUT SHORT CIRCUIT PROTECTION**
- **OVER-TEMPERATURE PROTECTION**
- **LOW OUTPUT RIPPLE AND NOISE**
- **FIXED SWITCHING FREQUENCY**
- **NEGATIVE OUTPUT APPLICATION**
- **SAFETY MEETS UL60950-1, EN60950-1 AND IEC60950-1**
- **COMPLIANT TO RoHS EU DIRECTIVE 2011/65/EU**

APPLICATIONS

Wireless Network
Telecom/Datacom
Industry Control System
Distributed Power Architectures
Semiconductor Equipment
Microprocessor Power Applications

DESCRIPTION

The SSR01-SERIES high performance switching regulators are suited to pick and place mass production. It provides 1A output current and high efficiency up to 95.5%. The SSR01 series feature output short circuit protection, over-current protection, and over-temperature protection. The SSR01 series can also be used to converter a positive voltage into a negative voltage.

TECHNICAL SPECIFICATION

All specifications are typical at nominal input, full load and 25°C otherwise noted

OUTPUT SPECIFICATIONS		
Output current	See table	1000mA, max.
Voltage accuracy		±2%Vout, max.
Minimum load		0%
Line regulation		± 0.2% Vout
Load regulation	0% to 100% of Full load	± 0.6% Vout
	10% to 90% of Full load	± 0.3% Vout
Ripple and noise (20MHz bandwidth)	Vout = 1.2V to 8V	50mVp-p
	Vout = 8.1 to 15.5V	75mVp-p
Temperature coefficient		±0.015%/°C, max.
Dynamic load response	Load change step	Peak deviation 150mV
	50%↔100% of F.L. Recovery time	250µs
Output current limit for Positive output	SSR01-05S2P5	400%
	others	200%
Output short-circuit	Continuous, automatics recovery	
Capacitor Load (Note 4)	470µF, max.	
Output voltage overshoot-startup	1% Vout, max.	
GENERAL SPECIFICATIONS		
Efficiency (Note 3)	See table	
Isolation voltage	None	
Switching frequency	See table	
Design meet safety standard	IEC60950-1, UL60950-1, EN60950-1	
Case material	Non-conductive black plastic	
Base material	Non-conductive black plastic	
Potting Material	Epoxy(UL94-V0)	
Dimensions	0.60 X 0.465 X 0.30 Inch	
	(15.2 X 11.82 X 7.6 mm)	
Weight	1.7g(0.067oz)	
MTBF (Note 1)	BELLCORE-TR-NWT-000332	2.683 x 10 ⁷ hrs
	MIL-HDBK-217F	4.508 x 10 ⁶ hrs

INPUT SPECIFICATIONS		
Input voltage range for positive output	Vin>Vout(set)+0.5V	3.0 ~ 5.5VDC
	Vin>Vout(set)+1.5V	4.6 ~ 36VDC
Input voltage range for negative output (Note 6)	See table	4.6 ~ 32VDC
	Vin+ Vout ≤36V	
Maximum input current	Vin(min), Full load	1A
Input filter	C filter	
Input reflected ripple current	100mA	
ENVIRONMENTAL SPECIFICATIONS		
Operating temperature range	-40°C ~ +85°C(with derating)	
Maximum case temperature	130°C	
Storage temperature range	-55°C ~ +125°C	
Lead-free reflow solder process	IPC J-STD-020D	
Moisture sensitivity level(MSL)	IPC J-STD-033B Level 1	
Thermal shock	MIL-STD-810F	
Vibration	MIL-STD-810F	
Relative humidity (non-condensing)	0% to 90% RH	
Over temperature protection	Internal IC junction	170 °C
FEATURE SPECIFICATIONS		
Start up time	Nominal Vin and constant resistive load	Power up Remote ON/OFF
		5ms 5ms
Remote ON/OFF (Note 5) (Positive logic)	DC-DC ON	Open or 2V < Vr < 5V
	DC-DC OFF	Short or 0V < Vr < 0.8V
Input current of Remote control pin	Nominal Input	-0.1mA ~ 0.1mA
Remote off state input current	Nominal Input	1.2mA

Note

1. BELLCORE TR-NWT-000332. Case I: 50% Stress, Temperature at 40°C. (Ground fixed and controlled environment)
MIL-HDBK-217F Notice2 @Ta=25 °C, Full load (Ground, Benign, controlled environment)
2. Typical value at nominal input voltage and no load.
3. Typical value at min. or max. input voltage and full load.
4. Tested with min. input voltage and constant resistive load.
5. Positive output : The ON/OFF control PIN voltage is referenced to GND.
Negative output : The ON/OFF control PIN voltage is referenced to -Vout.

CAUTION: This power module is not internally fused. An input line fuse must always be used.

Positive output

Model Name	Nominal Input	Input Voltage	Frequency	Nominal Output	Output Voltage Trim Range	Output Current		No Load Current (2)	Efficiency (%) (3)	
						Min.	Max.		Min. Vin	Max. Vin
SSR01-05S2P5	5.0V	3.0 ~ 5.5VDC	410kHz	2.5VDC	1.2 ~ 3.63VDC	0A	1A	6mA	95.5	95.0
SSR01-12S3P3	12V	4.6 ~ 36VDC	300kHz	3.3VDC	1.5 ~ 5.5VDC			1.5mA	87.5	80.0
SSR01-12S05	12V	6.5 ~ 36VDC	580kHz	5.0VDC	2.5 ~ 8.0VDC			3mA	91.5	83.5
SSR01-12S09	12V	10.5 ~ 36VDC	580kHz	9.0VDC	4.5 ~ 12.6VDC			4mA	94.5	89.0
SSR01-24S12	24V	13.5 ~ 36VDC	580kHz	12VDC	4.5 ~ 13.5VDC			4mA	95.0	91.0
SSR01-24S15	24V	16.5 ~ 36VDC	580kHz	15VDC	4.5 ~ 15.5VDC			4mA	95.5	92.5

SSR01-12S05 DERATING CURVE

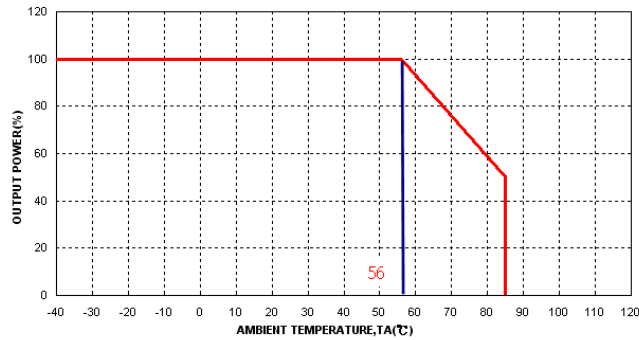

SSR01-12S05 EFFICIENCY VS INPUT VOLTAGE

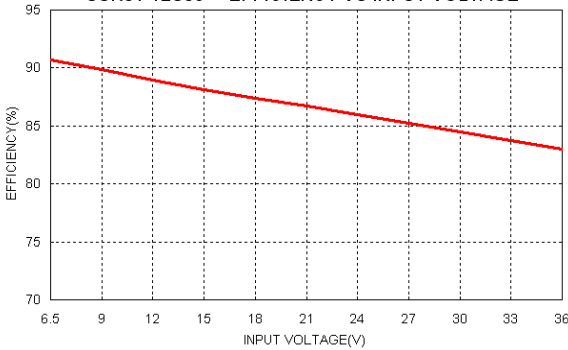

SSR01-12S05 EFFICIENCY VS LOAD

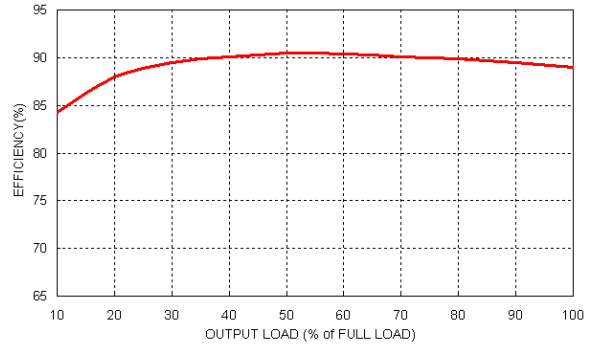

Negative output application

Model Name	Nominal Input	Input Voltage	Frequency	Nominal Output	Output Voltage Trim Range	Output Current		No Load Current (2)	Efficiency (%) (3)	
						Min.	Max.		Min. Vin	Max. Vin
SSR01-12S3P3	12V	4.6 ~ 32VDC	300kHz	-3.3VDC	-1.5 ~ -5.5VDC	0 A	0.6 A	3mA	74.0	77.5
SSR01-12S05	12V	4.6 ~ 31VDC	580kHz	-5.0VDC	-2.5 ~ -8.0VDC	0 A	0.4 A	3mA	80.0	78.5
SSR01-12S09	12V	7 ~ 27VDC	580kHz	-9.0VDC	-4.5 ~ -12.6VDC	0 A	0.3 A	7mA	85.0	82.0
SSR01-24S12	12V	7 ~ 24VDC	580kHz	-12VDC	-4.5 ~ -13.5VDC	0 A	0.3 A	7mA	84.5	86.0
SSR01-24S15	12V	7 ~ 21VDC	580kHz	-15VDC	-4.5 ~ -15.5VDC	0 A	0.2 A	10mA	85.5	84.0

SSR01-12S05 -5Vout DERATING CURVE

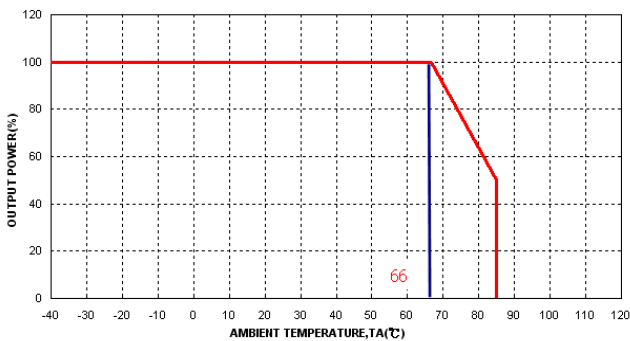

SSR01-12S05 -5Vout EFFICIENCY VS INPUT VOLTAGE

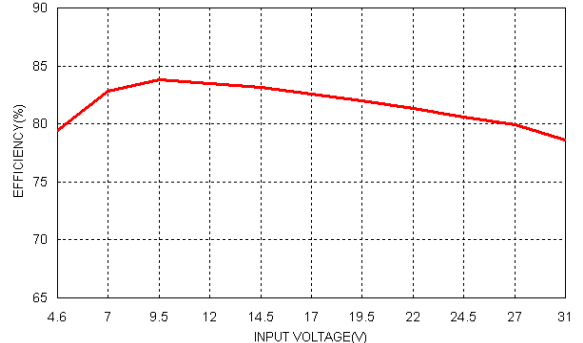

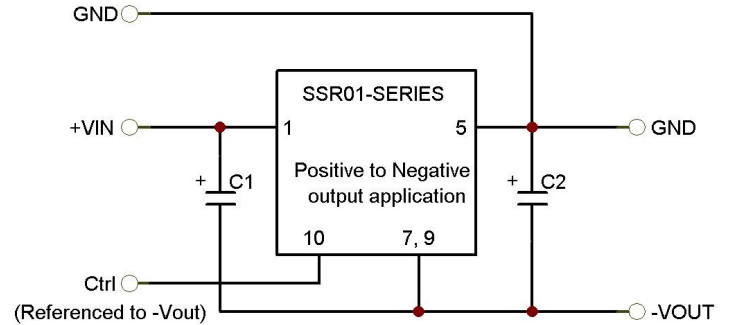
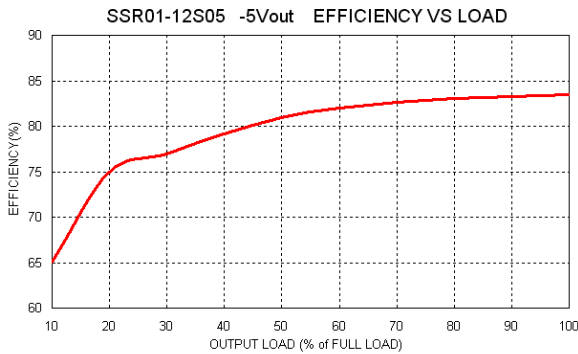

C1 and C2 are required and should be fitted close to the converter pins. Maximum capacitive load including C2 is 470uF.

C1	10uF / 50V	1210 X5R MLCC
C2	10uF / 25V	1206 X5R MLCC

OUTPUT TRIMMING

Part Number	Vout,nom	Trim Up(KΩ)	Trim Down	Part Number	Vout,nom	Trim Up	Trim Down
		$R_U(K\Omega)$	$R_D(K\Omega)$			$R_U(K\Omega)$	$R_D(K\Omega)$
SSR01-05S2P5	±2.5V	$= \frac{40.75}{V_o-2.5}$	$= \frac{50.75*V_o-40.75}{2.5-V_o}$	SSR01-12S09	±9.0V	$= \frac{80}{V_o-9.0}$	$= \frac{100*V_o-80}{9.0-V_o}$
SSR01-12S3P3	±3.3V	$= \frac{26.4}{V_o-3.3}$	$= \frac{33*V_o-26.4}{3.3-V_o}$	SSR01-24S12	±12.0V	$= \frac{240}{V_o-12.0}$	$= \frac{300*V_o-240}{12.0-V_o}$
SSR01-12S05	±5.0V	$= \frac{160}{V_o-5.0}$	$= \frac{200*V_o-160}{5.0-V_o}$	SSR01-24S15	±15.0V	$= \frac{240}{V_o-15.0}$	$= \frac{300*V_o-240}{15.0-V_o}$

The input voltage can be increased to 42VDC by external capacitors.

1.For Positive output:

Input capacitor is necessary when input voltage 36VDC increased to 42VDC. The input capacitor suggestion is 22uF

2.For Negative output application:

The input and output capacitors are necessary for negative output application when the 36VDC be increased to 42VDC, and the suggestion of capacitors: The C1 is 22uF and the C2 is 10uF. (Please refer to the figure of positive to negative output application)

Consider to the maximum duty of internal controller. In the trim down application, these are some condition that input range can't increase to 42VDC.

MODEL NUMBER	Output voltage(Trim down)	Input range
SSR01-12S09	-4.5 ~ -6VDC	$V_{in} + V_{out} \leq 36VDC$
SSR01-24S12	-4.5 ~ -6VDC	$V_{in} + V_{out} \leq 36VDC$
SSR01-24S15	-4.5 ~ -6VDC	$V_{in} + V_{out} \leq 36VDC$

MECHANICAL DRAWING

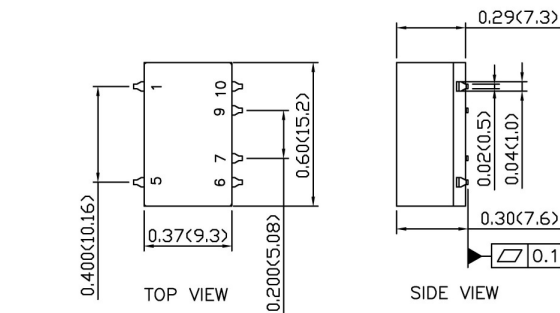

PIN CONNECTION	
PIN	DEFINE
1	+VIN
5	+VOUT
6	TRIM
7	GND
9	GND
10	CTRL

EXTERNAL OUTPUT TRIMMING

Output can be externally trimmed by using the method shown below.

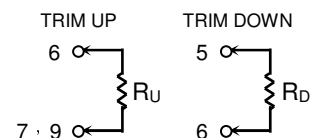

- All dimensions in Inch (mm)
Tolerance: X.XX±0.02 (X.X±0.5)
X.XXX±0.01 (X.XX±0.25)
- Pin pitch tolerance ±0.01(0.25)
- Pin dimension tolerance ±0.004 (0.1)