

OUTLINE

The R3113D series are CMOS-based voltage detector ICs with high detector threshold accuracy and ultra-low supply current, which can be operated at an extremely low voltage and is used for system reset as an example.

Each of these ICs consists of a voltage reference unit, a comparator, resistors for detector threshold setting, an output driver and a hysteresis circuit. The detector threshold is fixed with high accuracy internally and does not require any adjustment.

Two output types, Nch open drain type and CMOS type are available.

Since the package is ultra-small SON1408-3 (MFPK), high density mounting on board is possible .

FEATURES

- Ultra-low Supply CurrentTyp. 1.4 μ A ($V_{DET}>1.5V$: $V_{DD}=V_{DET}+1.0V$)
- Wide Range of Operating Voltage0.6V to 6.0V ($V_{DET}=3.0V$, $T_{opt}=25^{\circ}C$)
- Detector ThresholdStepwise setting with a step of 0.1V in the range
from 1.2V to 4.5V is possible.
- High Accuracy Detector Threshold $\pm 2.0\%$
- Low Temperature-Drift Coefficient of Detector Threshold...Typ. $\pm 100ppm/^{\circ}C$
- Two Output TypesNch Open Drain and CMOS
- Ultra-small PackageSON1408-3

APPLICATIONS

- CPU and Logic Circuit Reset
- Battery Checker
- Window Comparator
- Wave Shaping Circuit
- Battery Back-up Circuit
- Power Failure Detector

BLOCK DIAGRAMS

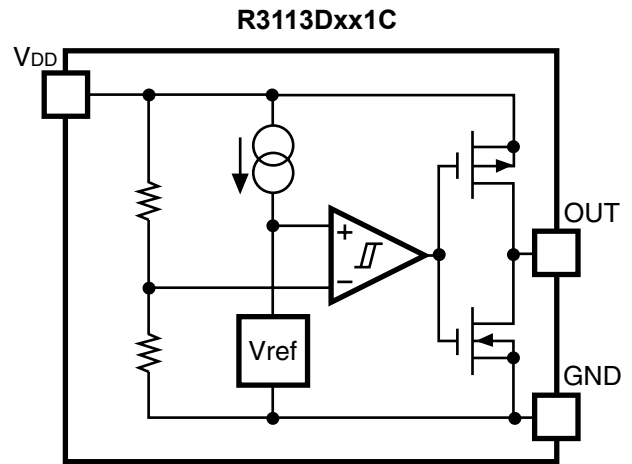
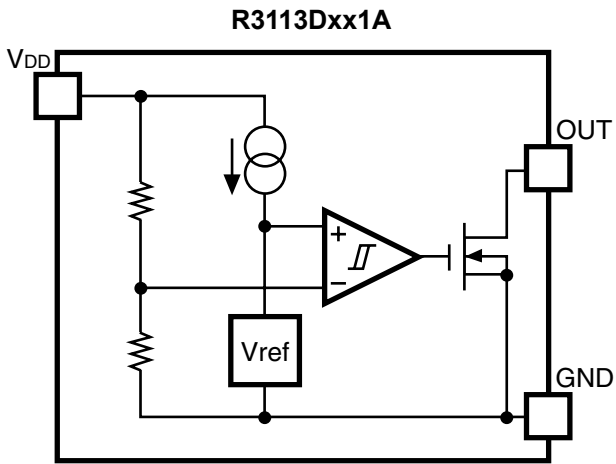

TIMING CHART

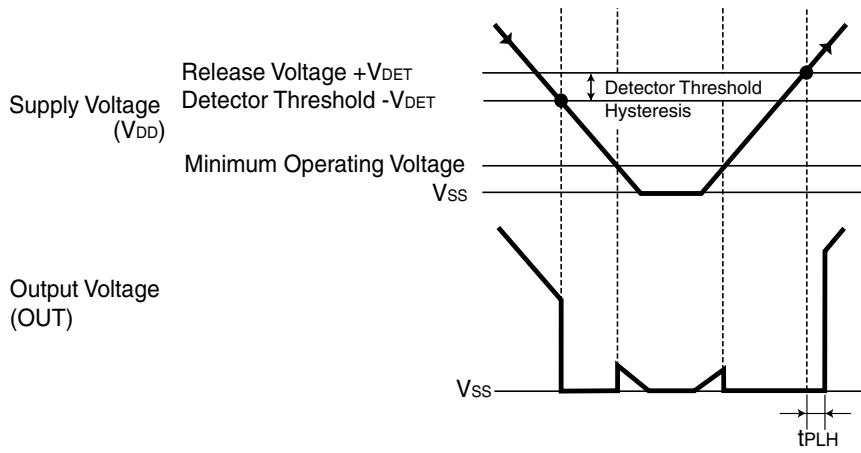

DEFINITION OF OUTPUT DELAY TIME

Output Delay Time t_{PLH} is defined as follows:

1. In the case of Nch Open Drain Output:

Under the condition of the output pin (OUT) is pulled up through a resistor of 470k Ω to 5V, the time interval between the rising edge of V_{DD} pulse from 0.85V to $(+V_{DET})+ 1.0V$ and becoming of the output voltage to 2.5V.

2. In the case of CMOS Output:

The time interval between the rising edge of V_{DD} pulse from 0.85V to $(+V_{DET})+ 1.0V$ and becoming of the output voltage to $(V_{DD}/2)$ V.

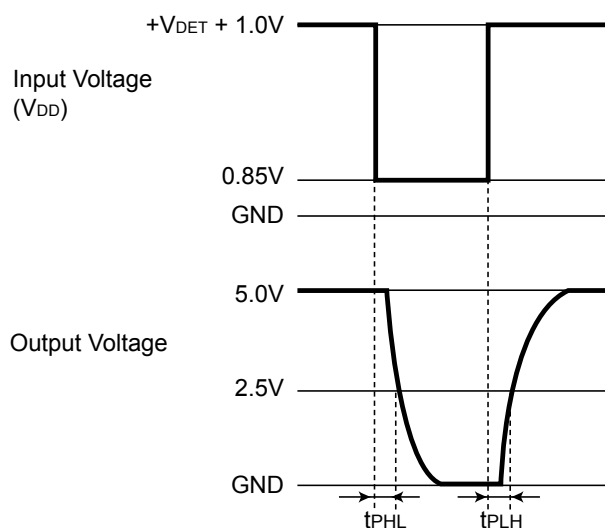

Nch Open Drain Output

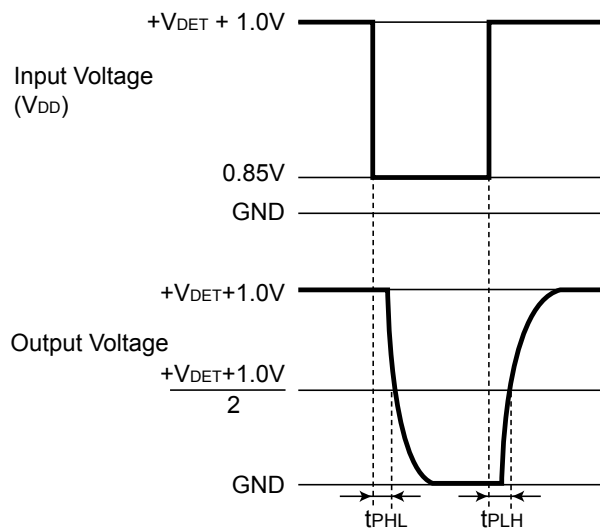

CMOS Output

SELECTION GUIDE

The detector threshold, the output type and the taping type of R3113 Series can be designated at the users' request by specifying the part number as follows;

R3113xxx1x-xx ← Part Number
 ↑ ↑ ↑ ↑
 a b c d

Code	Contents
a	Designation of Package Type; SON1408-3
b	Setting Detector Threshold ($-V_{DET}$); Stepwise setting with a step of 0.1V in the range of 1.2V to 4.5V is possible.
c	Designation of Output Type; A: Nch Open Drain C: CMOS
d	Designation of Packing or Taping Type; Ex. TR prescribed as standard directions. (Refer to Taping Specifications.) Antistatic bag for samples: C

PIN CONFIGURATION

● SON1408-3

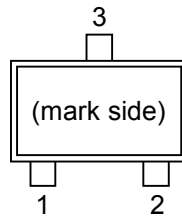

PIN DESCRIPTION

● R3113D

Pin No.	Symbol	Description
1	OUT	Output Pin
2	V _{DD}	Input Pin
3	GND	Ground Pin

ABSOLUTE MAXIMUM RATINGS

Symbol	Item	Rating	Unit
V _{DD}	Supply Voltage	6.5	V
V _{OUT1}	Output Voltage (CMOS)	V _{SS} -0.3 to V _{DD} +0.3	V
V _{OUT2}	Output Voltage (Nch)	V _{SS} -0.3 to 6.5	V
I _{OUT}	Output Current	20	mA
P _D	Power Dissipation ^{*Note1}	250	mW
T _{opt}	Operating Temperature Range	-40 to 85	°C
T _{stg}	Storage Temperature Range	-55 to 125	°C
T _{solder}	Lead temperature (Soldering)	260°C, 10s	

*Note 1: Applied to SON1408-3 at mounted on board

P_D depends on conditions of mounting on board.

This specification is based on the measurement at the condition below:

*Measurement Conditions

Environment: Mounted on board (Wind velocity 0m/s)

Board Material: FR-4 (2-layer)

Board dimensions: 40mm × 40mm × t1.6mm

Copper Area: 50%(Both Sides)

Tab pin (Pin 3) land pattern width is same as the lead, connected to the GND plane.

ELECTRICAL CHARACTERISTICS

• R3113D121A/C

T_{opt}=25°C

Symbol	Item	Conditions	Min.	Typ.	Max.	Unit
-V _{DET}	Detector Threshold		1.176	1.200	1.224	V
V _{HYS}	Detector Threshold Hysteresis		0.036	0.060	0.084	V
I _{SS}	Supply Current	V _{DD} = (-V _{DET})-0.1V (-V _{DET})+1.0V		0.8 1.1	2.0 2.7	μA
V _{DDH}	Maximum Operating Voltage				6	V
V _{DDL}	Minimum Operating Voltage ^{*Note1}	T _{opt} =25°C		0.65	0.85	V
		-40°C ≤ T _{opt} ≤ 85°C			0.95	
I _{OUT}	Output Current (Driver Output Pin)	Nch V _{DS} =0.05V, V _{DD} =0.85V V _{DS} =0.50V, V _{DD} =1.10V	0.2 1.0	0.3 2.2		mA
		Pch V _{DS} =-2.1V, V _{DD} =4.5V	2.0	5.0		
t _{PLH}	Output Delay Time ^{*Note2}				100	μs
Δ-V _{DET} /ΔT	Detector Threshold Temperature Coefficient	-40°C ≤ T _{opt} ≤ 85°C		±100		ppm/°C

• R3113D181A/C

T_{opt}=25°C

Symbol	Item	Conditions	Min.	Typ.	Max.	Unit
-V _{DET}	Detector Threshold		1.764	1.800	1.836	V
V _{HYS}	Detector Threshold Hysteresis		0.054	0.090	0.126	V
I _{SS}	Supply Current	V _{DD} = (-V _{DET})-0.1V (-V _{DET})+1.0V		1.3 1.4	3.3 3.6	μA
V _{DDH}	Maximum Operating Voltage				6	V
V _{DDL}	Minimum Operating Voltage ^{*Note1}	T _{opt} =25°C		0.45	0.70	V
		-40°C ≤ T _{opt} ≤ 85°C			0.80	
I _{OUT}	Output Current (Driver Output Pin)	Nch V _{DS} =0.05V, V _{DD} =0.70V V _{DS} =0.50V, V _{DD} =1.50V	0.05 2.00	0.13 5.00		mA
		Pch V _{DS} =-2.1V, V _{DD} =4.5V	2.0	5.0		
t _{PLH}	Output Delay Time ^{*Note2}				100	μs
Δ-V _{DET} /ΔT	Detector Threshold Temperature Coefficient	-40°C ≤ T _{opt} ≤ 85°C		±100		ppm/°C

R3113D● **R3113D271A/C**T_{opt}=25°C

Symbol	Item	Conditions	Min.	Typ.	Max.	Unit
-V _{DET}	Detector Threshold		2.646	2.700	2.754	V
V _{HYS}	Detector Threshold Hysteresis		0.081	0.135	0.189	V
I _{SS}	Supply Current	V _{DD} = (-V _{DET})-0.1V (-V _{DET})+1.0V		1.3 1.4	3.3 3.6	μA
V _{DDH}	Maximum Operating Voltage				6	V
V _{DDL}	Minimum Operating Voltage ^{*Note1}	T _{opt} =25°C		0.45	0.70	V
		-40°C ≤ T _{opt} ≤ 85°C			0.80	
I _{OUT}	Output Current (Driver Output Pin)	Nch V _{DS} =0.05V, V _{DD} =0.70V V _{DS} =0.50V, V _{DD} =1.50V	0.05 2.00	0.13 5.00		mA
		Pch V _{DS} =-2.1V, V _{DD} =4.5V	2.0	5.0		mA
t _{PLH}	Output Delay Time ^{*Note2}				100	μs
Δ-V _{DET} /ΔT	Detector Threshold Temperature Coefficient	-40°C ≤ T _{opt} ≤ 85°C		±100		ppm/°C

● **R3113D361A/C**T_{opt}=25°C

Symbol	Item	Conditions	Min.	Typ.	Max.	Unit
-V _{DET}	Detector Threshold		3.528	3.600	3.672	V
V _{HYS}	Detector Threshold Hysteresis		0.108	0.180	0.252	V
I _{SS}	Supply Current	V _{DD} = (-V _{DET})-0.1V (-V _{DET})+1.0V		1.3 1.4	3.3 3.6	μA
V _{DDH}	Maximum Operating Voltage				6	V
V _{DDL}	Minimum Operating Voltage ^{*Note1}	T _{opt} =25°C		0.45	0.70	V
		-40°C ≤ T _{opt} ≤ 85°C			0.70	
I _{OUT}	Output Current (Driver Output Pin)	Nch V _{DS} =0.05V, V _{DD} =0.70V V _{DS} =0.50V, V _{DD} =1.50V	0.05 2.00	0.13 5.00		mA
		Pch V _{DS} =-2.1V, V _{DD} =4.5V	2.0	5.0		mA
t _{PLH}	Output Delay Time ^{*Note2}				100	μs
Δ-V _{DET} /ΔT	Detector Threshold Temperature Coefficient	-40°C ≤ T _{opt} ≤ 85°C		±100		ppm/°C

• R3113D451A/C

T_{opt}=25°C

Symbol	Item	Conditions	Min.	Typ.	Max.	Unit
-V _{DET}	Detector Threshold		4.410	4.500	4.590	V
V _{HYS}	Detector Threshold Hysteresis		0.135	0.225	0.315	V
I _{SS}	Supply Current	V _{DD} = (-V _{DET})-0.1V (-V _{DET})+1.0V		1.3 1.4	3.3 3.6	μA
V _{DDH}	Maximum Operating Voltage				6	V
V _{DDL}	Minimum Operating Voltage ^{*Note1}	T _{opt} =25°C		0.45	0.70	V
		-40°C ≤ T _{opt} ≤ 85°C			0.80	
I _{OUT}	Output Current (Driver Output Pin)	Nch V _{DS} =0.05V, V _{DD} =0.70V V _{DS} =0.50V, V _{DD} =1.50V	0.05 2.00	0.13 5.00		mA
		Pch V _{DS} =-2.1V, V _{DD} =6.0V	2.5	6.0		mA
t _{PLH}	Output Delay Time ^{*Note2}				100	μs
Δ-V _{DET} /ΔT	Detector Threshold Temperature Coefficient	-40°C ≤ T _{opt} ≤ 85°C		±100		ppm/°C

*Note1: The Minimum operating voltage means the value of input voltage when output voltage maintains 0.1V or less. (In the case of Nch Open Drain Output type, the output pin is pulled up with a resistance of 470kΩ to 5.0V.)

*Note2: In the case of CMOS Output type: The time interval between the rising edge of V_{DD} input pulse from 0.85V to (+V_{DET}) +1.0V and output voltage level becoming to V_{DD}/2.

ELECTRICAL CHARACTERISTICS BY DETECTOR THRESHOLD

● R3113D121x to R3113D451x

Part Number	Detector Threshold			Detector Threshold Hysteresis			Supply Current 1			Supply Current 2		
	-V _{DET} [V]			V _{HYS} [V]			I _{SS1} [μA]			I _{SS2} [μA]		
	Min	Typ.	Max.	Min.	Typ.	Max.	Condition	Typ.	Max.	Condition	Typ.	Max.
R3113D121x	1.1	1.200	1.224	0.036	0.060	0.084	V _{DD} = (-V _{DET}) -0.10V	0.8	2.0	V _{DD} = (-V _{DET}) +1.0V	1.1	2.7
R3113D131x	1.2	1.300	1.326	0.039	0.065	0.091						
R3113D141x	1.3	1.400	1.428	0.042	0.070	0.098						
R3113D151x	1.4	1.500	1.530	0.045	0.075	0.105						
R3113D161x	1.5	1.600	1.632	0.048	0.080	0.112						
R3113D171x	1.6	1.700	1.734	0.051	0.085	0.119						
R3113D181x	1.7	1.800	1.836	0.054	0.090	0.126						
R3113D191x	1.8	1.900	1.938	0.057	0.095	0.133						
R3113D201x	1.9	2.000	2.040	0.060	0.100	0.140						
R3113D211x	2.0	2.100	2.142	0.063	0.105	0.147						
R3113D221x	2.1	2.200	2.244	0.066	0.110	0.154						
R3113D231x	2.2	2.300	2.346	0.069	0.115	0.161						
R3113D241x	2.3	2.400	2.448	0.072	0.120	0.168						
R3113D251x	2.4	2.500	2.550	0.075	0.125	0.175						
R3113D261x	2.5	2.600	2.652	0.078	0.130	0.182						
R3113D271x	2.6	2.700	2.754	0.081	0.135	0.189						
R3113D281x	2.7	2.800	2.856	0.084	0.140	0.196						
R3113D291x	2.8	2.900	2.958	0.087	0.145	0.203						
R3113D301x	2.9	3.000	3.060	0.090	0.150	0.210						
R3113D311x	3.0	3.100	3.162	0.093	0.155	0.217						
R3113D321x	3.1	3.200	3.264	0.096	0.160	0.224						
R3113D331x	3.2	3.300	3.366	0.099	0.165	0.231						
R3113D341x	3.3	3.400	3.468	0.102	0.170	0.238						
R3113D351x	3.4	3.500	3.570	0.105	0.175	0.245						
R3113D361x	3.5	3.600	3.672	0.108	0.180	0.252						
R3113D371x	3.6	3.700	3.774	0.111	0.185	0.259						
R3113D381x	3.7	3.800	3.876	0.114	0.190	0.266						
R3113D391x	3.8	3.900	3.978	0.117	0.195	0.273						
R3113D401x	3.9	4.000	4.080	0.120	0.200	0.280						
R3113D411x	4.0	4.100	4.182	0.123	0.205	0.287						
R3113D421x	4.1	4.200	4.284	0.126	0.210	0.294						
R3113D431x	4.2	4.300	4.386	0.129	0.215	0.301						
R3113D441x	4.3	4.400	4.488	0.132	0.220	0.308						
R3113D451x	4.4	4.500	4.590	0.135	0.225	0.315						

*Note1: In the case of CMOS Output type: The time interval between the rising edge of V_{DD} input pulse from 0.85V to (+V_{DET}) +1.0V and output voltage level becoming to V_{DD}/2.

Condition1: T_{opt}=25°C

Condition2: -40°C ≤ T_{opt} ≤ 85°C

*Note2: The Minimum operating voltage means the value of input voltage when output voltage maintains 0.1V or less. (In the case of Nch Open Drain Output type, the output pin is pulled up with a resistance of 470kΩ to 5.0V.)

Output Current 1			Output Current 2			Output Delay Time	Minimum Operating Voltage		Detector Threshold Temperature Coefficient		
I _{OUT1} [mA]			I _{OUT2} [mA]			t _{PLH} [μs]	V _{DDL} [V]		Δ-V _{DET} /ΔT[ppm/°C]		
Condition	Min.	Typ.	Condition	Min.	Typ.	Max.	Typ.	Max.	Condition	Typ.	
Nch V _{DS} =0.05V V _{DD} =0.85V	0.2	0.3	Nch V _{DS} = 0.5V	V _{DD} = 1.1V	1.0	2.2	Note 1 100	Note 2 Condition 1 0.65 Condition 2	Condition 1 0.85 Condition 2 0.95	-40°C ≤ T _{opt} ≤ 85°C	±100
Nch V _{DS} =0.05V V _{DD} =0.7V	0.05	0.13		V _{DD} = 1.5V	2.0	5.0		Note 2 Condition 1 0.45 Condition 2	Note 2 Condition 1 0.70 Condition 2 0.80		

OPERATION

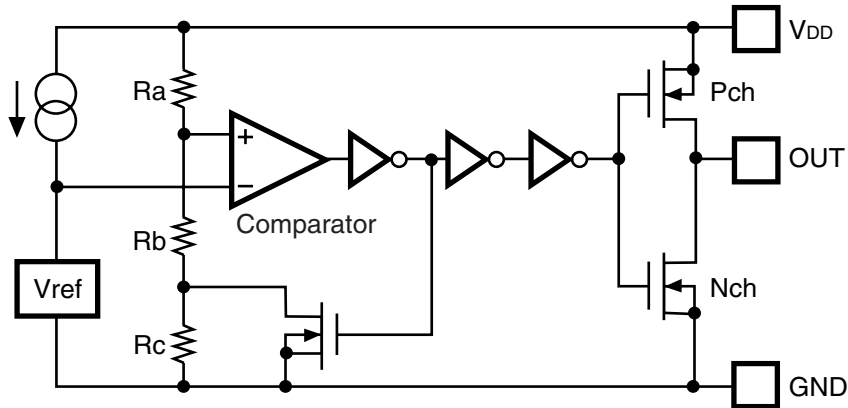

Figure 1. Block Diagram

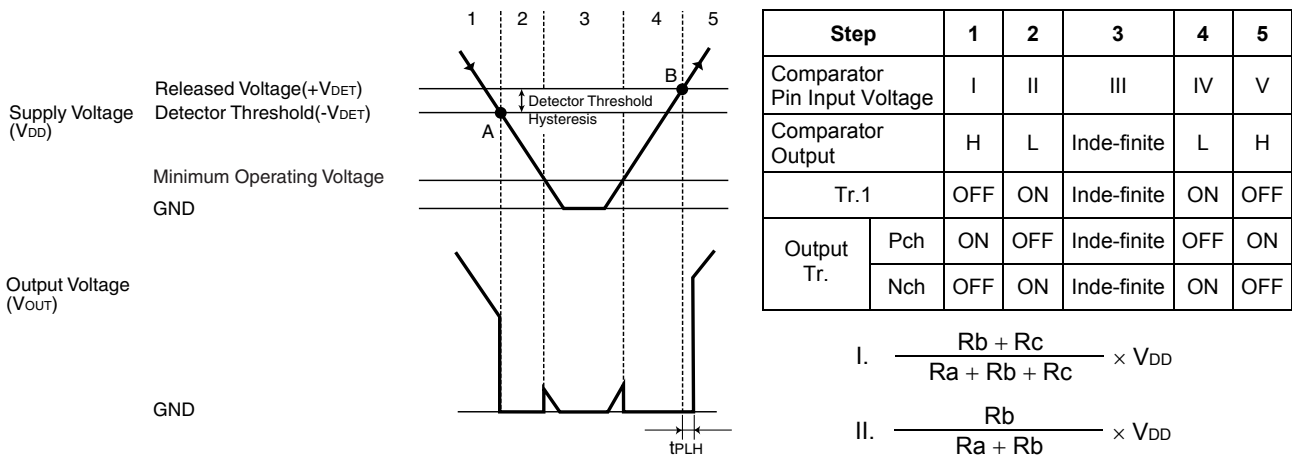

Figure 2. Operation Diagram

Step 1. The output voltage is equal to the supply voltage (V_{DD}).

Step 2. At Point "A", $V_{ref} \geq V_{DD} \times (R_b + R_c) / (R_a + R_b + R_c)$ is true, as a result, the output of comparator is reverse, and output voltage becomes to GND level. The voltage level of Point A means detector threshold voltage, or ($-V_{DET}$).

Step 3. When the supply voltage is less than minimum operating voltage, the operation of output transistor becomes indefinite, and in the case that output is pulled up to V_{DD} , the output voltage equals to V_{DD} voltage.

Step 4. The output voltage equals to GND level.

Step 5. At Point "B", $V_{ref} \geq V_{DD} \times R_b / (R_a + R_b)$ is true, Output of the comparator is reverse, and output voltage is equal to the supply voltage, or (V_{DD}). The voltage level of Point B means released voltage, or ($+V_{DET}$).

* The difference between released voltage and detector threshold voltage is the detector threshold hysteresis.

TEST CIRCUITS

*Pull-up circuit is not necessary for CMOS Output type, or R3113DxxxC.

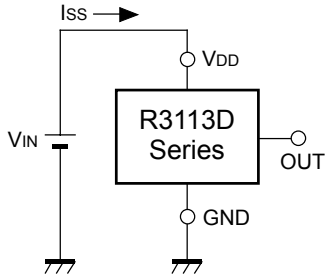

Figure 3. Supply Current Test Circuit

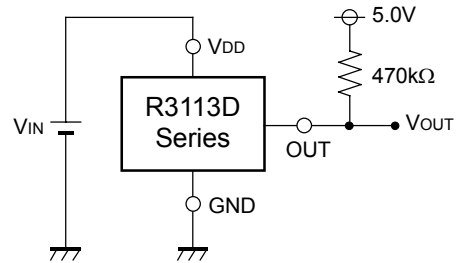

Figure 4. Detector Threshold Test Circuit

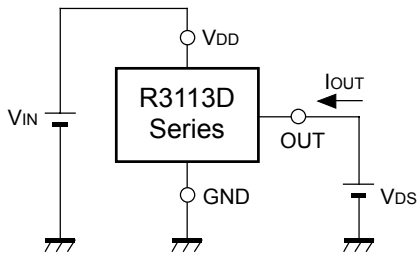

Figure 5. Nch Driver Output Current Test Circuit

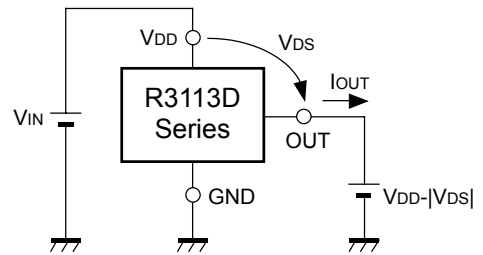

Figure 6. Pch Driver Output Current Test Circuit

*Apply only to CMOS

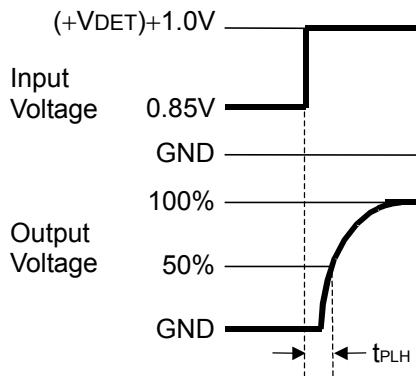

Figure 7. Output Delay Time Test Circuit (1)

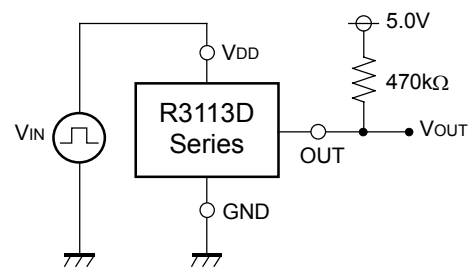
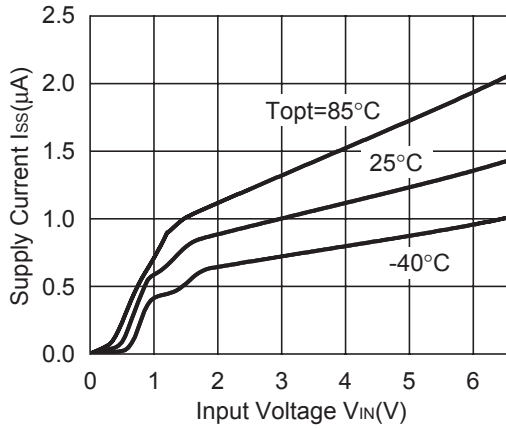

Figure 8. Output Delay Time Test Circuit (2)

TYPICAL CHARACTERISTICS

1) Supply Current vs. Input Voltage

R3113D121C



R3113D271C

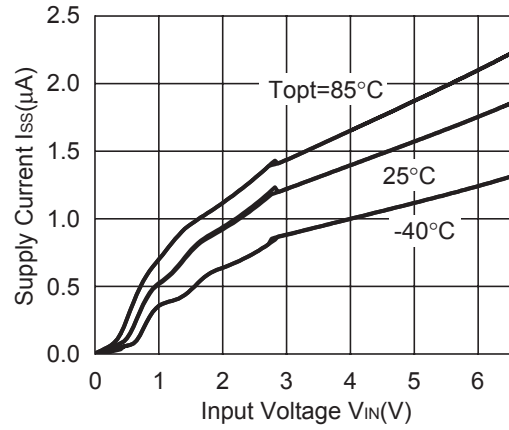

R3113D451C

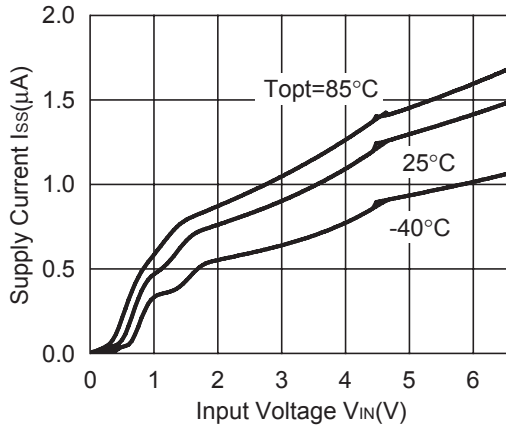

2) Detector Threshold Hysteresis vs. Temperature

R3113D121C

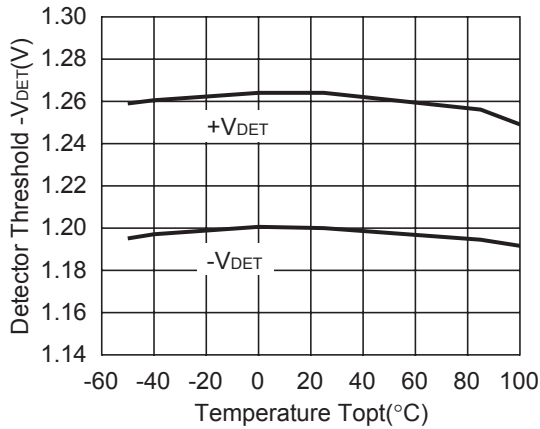

R3113D271C

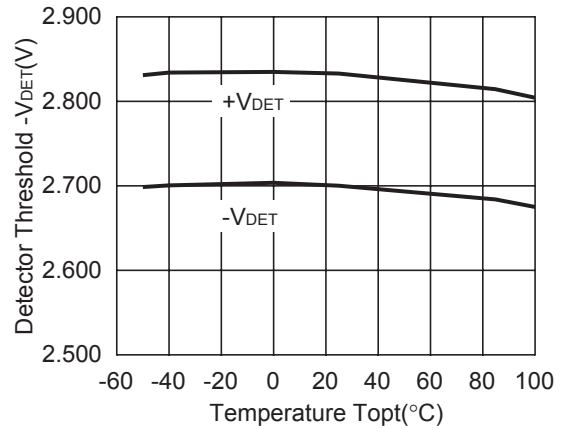

R3113D451C

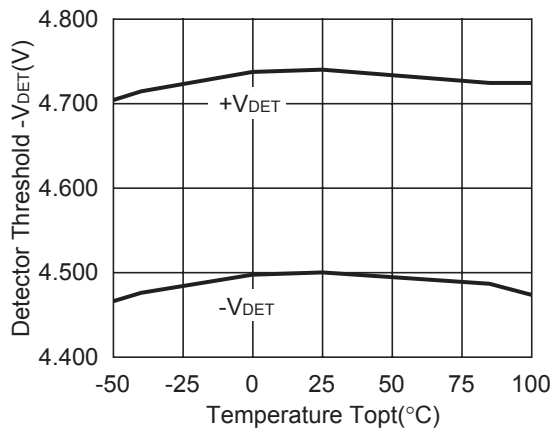

3) Output Voltage vs. Input Voltage

R3113D121C

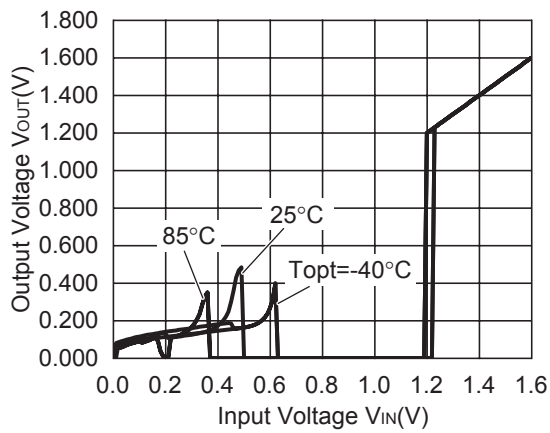

R3113D121A

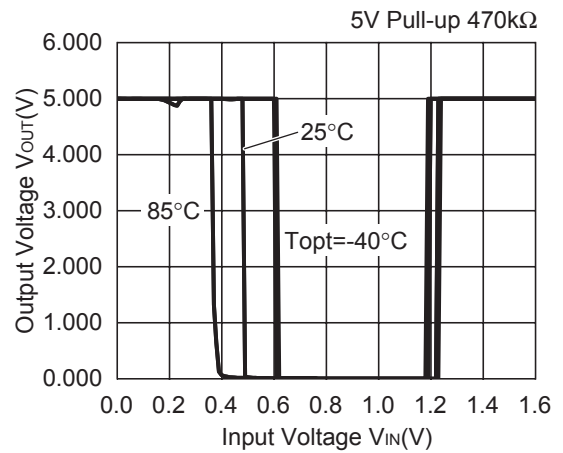

R3113D271C

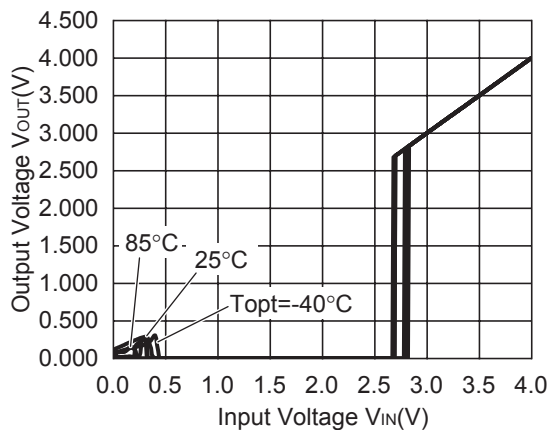

R3113D271A

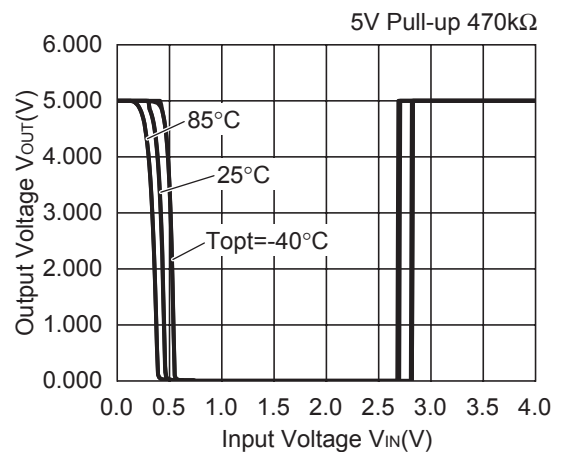

R3113D451C

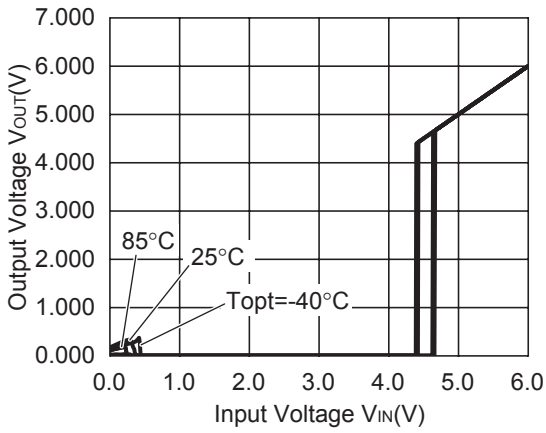

R3113D451A

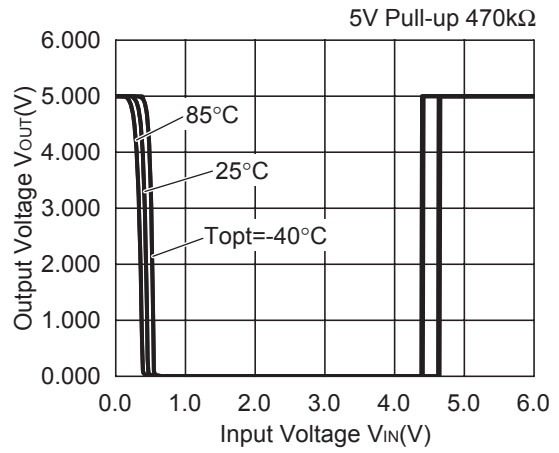

4) Nch Driver Output Current vs. V_{ds}

R3113D121C

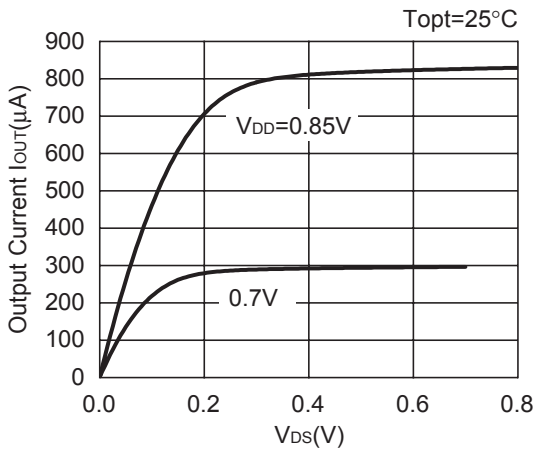

R3113D121C

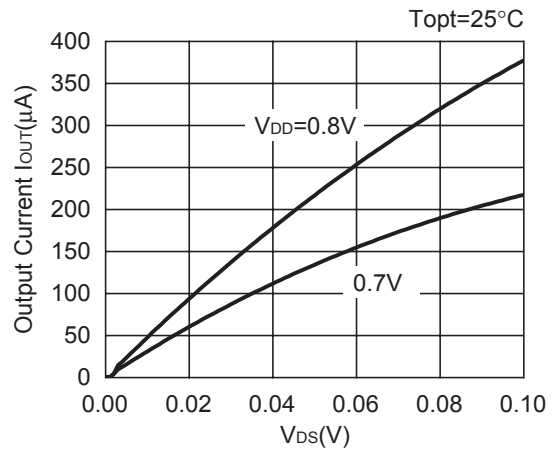

R3113D271C

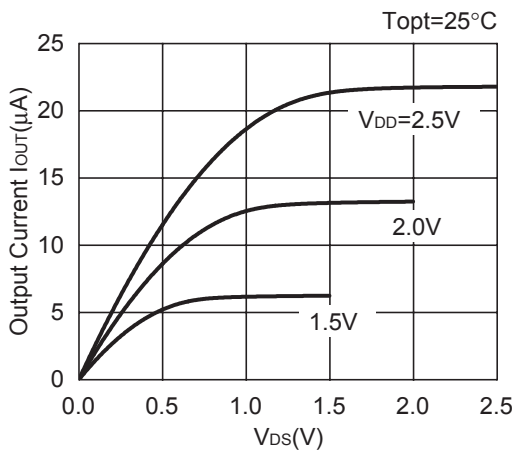

R3113D271C

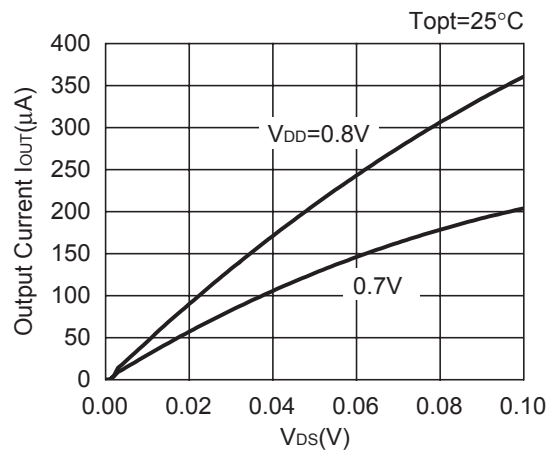

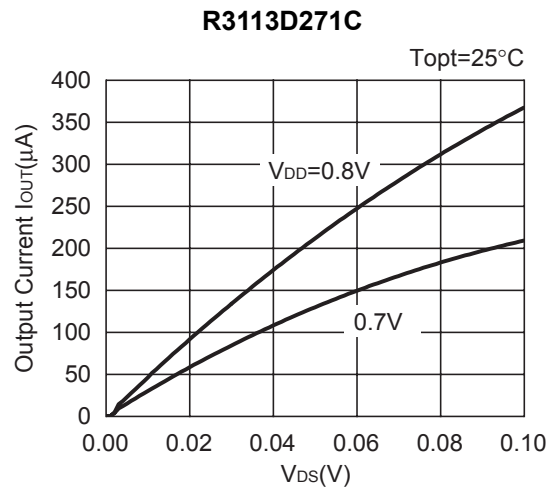
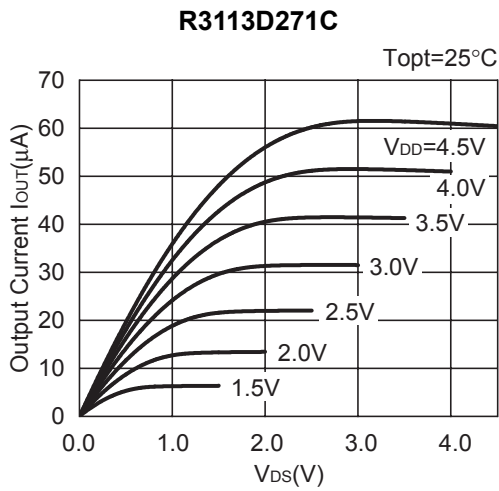

5) Nch Driver Output Current vs. Input Voltage

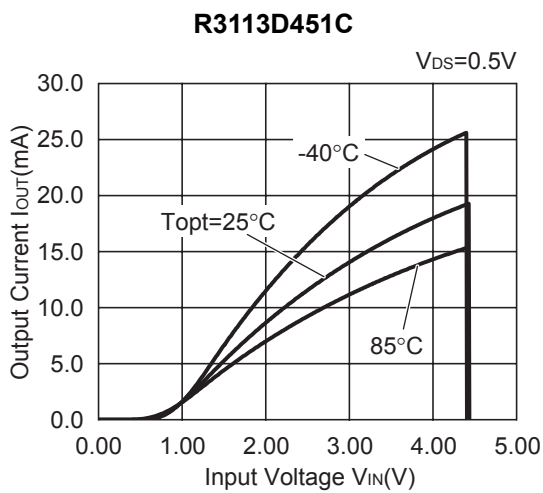
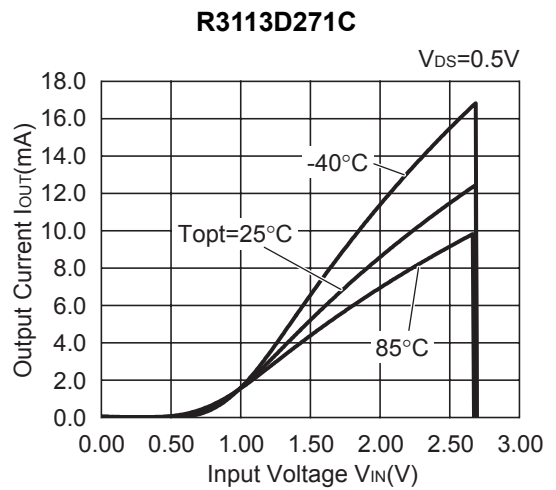
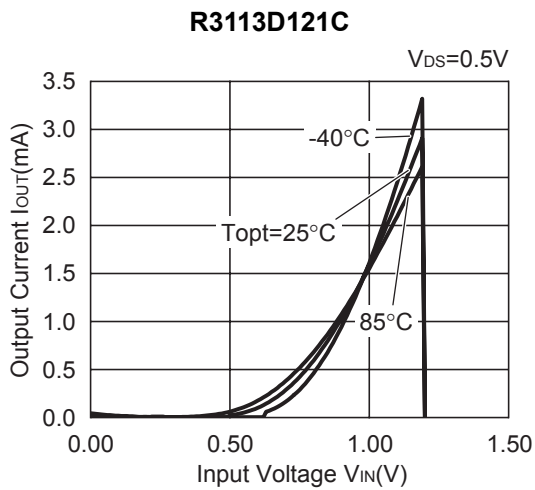

6) Pch Driver Output Current vs. Input Voltage

R3113D121C

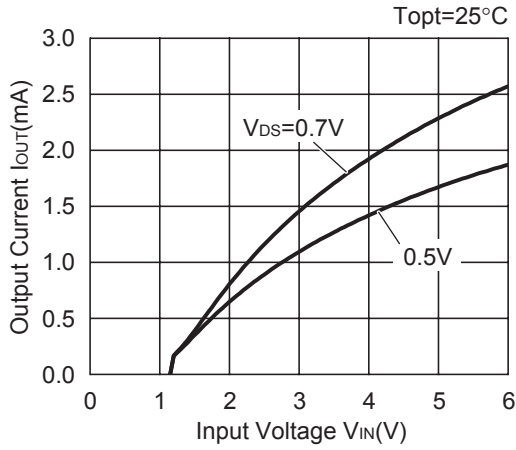

R3113D271C

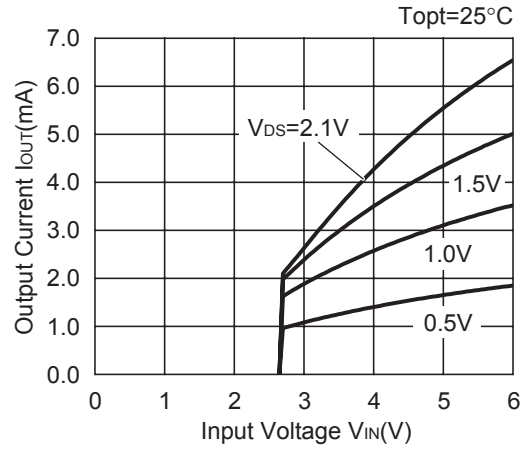

R3113D451C

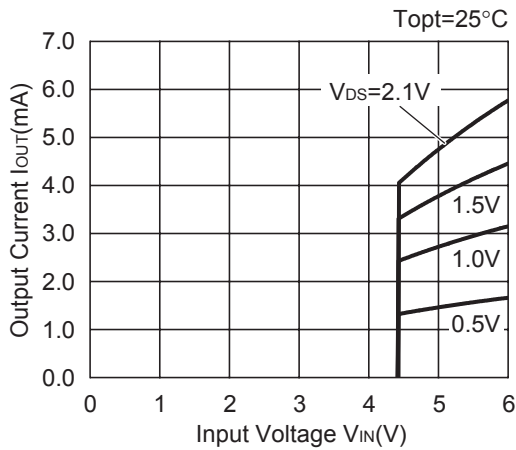

7) Output Delay Time vs. Load Capacitance

R3113D121A

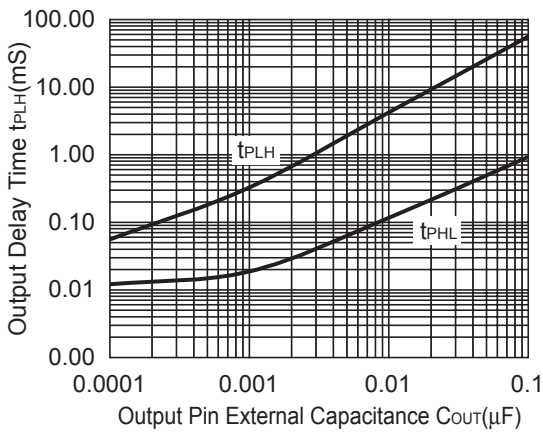

R3113D271A

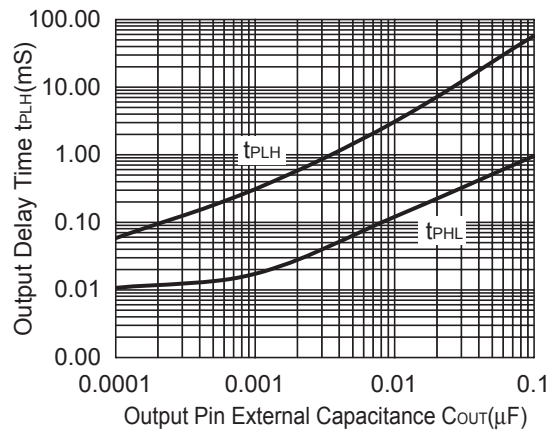

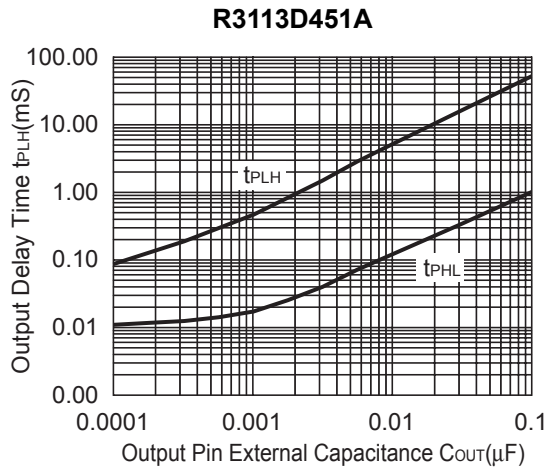

8) Output Delay Time vs. Input Pin Capacitance

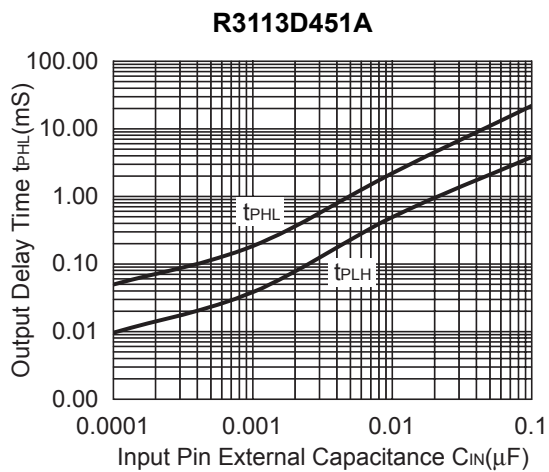
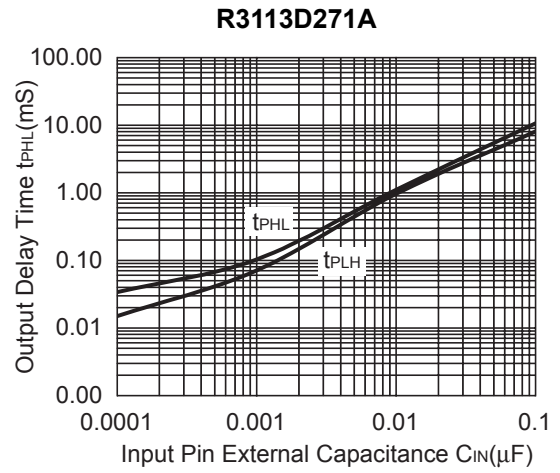
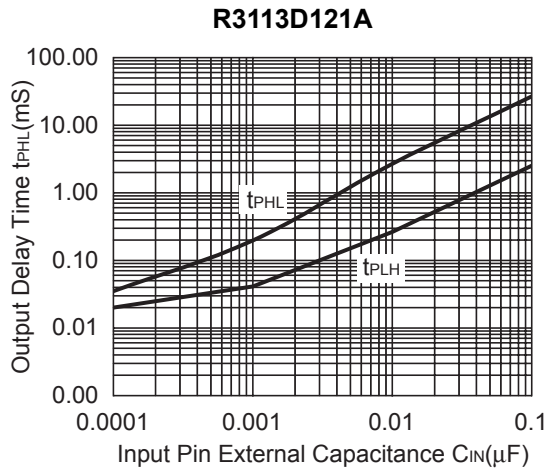

TECHNICAL NOTES

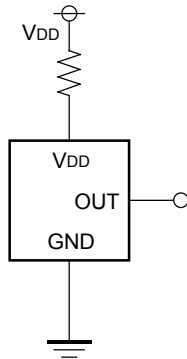

Figure 9

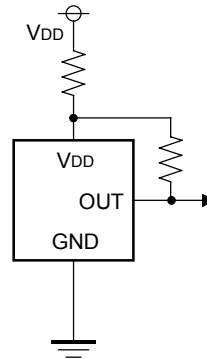

Figure 10

- In Figure 9, When R3113Dxx1C is used, and if an impedance is connected between Voltage Supplier and the V_{DD} Pin of R3113Dxx1C Series, the operation might be unstable by cross conduction current at detection.

When R3113Dxx1A is used in Figure 9, if the value of R is set excessively large, voltage drop may occur caused by supply current of IC itself and Detector threshold may vary.
- Wiring as shown in Figure 10 may cause the oscillation in both output types of R3113 Series.