

Small Signal MOSFET

20 V, 238 mA, Single, N-Channel, Gate ESD Protection

Features

- Low Gate Charge for Fast Switching
- Small 1.6 x 1.6 mm Footprint
- ESD Protected Gate
- Pb-Free Package is Available
- ESD Protected:2000V

Applications

- Power Management Load Switch
- Level Shift
- Portable Applications such as Cell Phones, Media Players, Digital Cameras, PDA's, Video Games, Hand Held Computers, etc.

MAXIMUM RATINGS (T_J = 25°C unless otherwise stated)

Parameter		Symbol	Value	Unit
Drain-to-Source Voltage		V _{DSS}	20	V
Gate-to-Source Voltage		V _{GS}	±10	V
Continuous Drain Current (Note 1)	Steady State = 25°C	I _D	238	mA
Power Dissipation (Note 1)	Steady State = 25°C	P _D	300	mW
Pulsed Drain Current	t _p ≤ 10 μs	I _{DM}	714	mA
Operating Junction and Storage Temperature		T _J , T _{STG}	-55 to 150	°C
Continuous Source Current (Body Diode)		I _{SD}	238	mA
Lead Temperature for Soldering Purposes (1/8" from case for 10 s)		T _L	260	°C

Stresses exceeding Maximum Ratings may damage the device. Maximum Ratings are stress ratings only. Functional operation above the Recommended Operating Conditions is not implied. Extended exposure to stresses above the Recommended Operating Conditions may affect device reliability.

THERMAL RESISTANCE RATINGS

Parameter	Symbol	Max	Unit
Junction-to-Ambient – Steady State (Note 1)	R _{θJA}	416	°C/W

1. Surface-mounted on FR4 board using 1 in sq. pad size (Cu area = 1.127 in sq. [1 oz] including traces).

LNTA4001NT1G

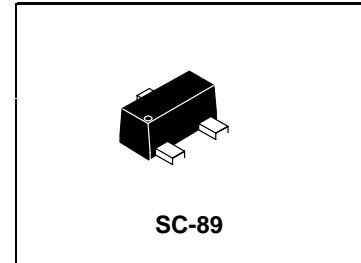

V _{(BR)DSS}	R _{DS(on)} Typ @ V _{GS}	I _D MAX (Note 1)
20 V	1.5 Ω @ 4.5 V	238 mA
	2.2 Ω @ 2.5 V	

PIN CONNECTIONS

SC-89 (3-Leads)

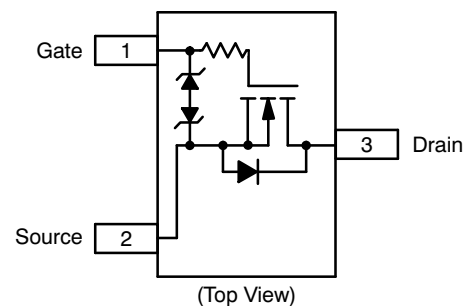

MARKING DIAGRAM

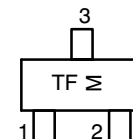

TF = Specific Device Code
M = Month Code

ORDERING INFORMATION

Device	Package	Shipping
LNTA4001NT1G	SC-89	3000 Tape & Reel
LNTA4001NT3G	SC-89	10000 Tape & Reel

LNTA4001NT1G
ELECTRICAL CHARACTERISTICS ($T_J = 25^\circ\text{C}$ unless otherwise specified)

Parameter	Symbol	Test Condition	Min	Typ	Max	Unit
OFF CHARACTERISTICS						
Drain-to-Source Breakdown Voltage	$V_{(BR)DSS}$	$V_{GS} = 0\text{ V}, I_D = 100\ \mu\text{A}$	20			V
Zero Gate Voltage Drain Current	I_{DSS}	$V_{GS} = 0\text{ V}, V_{DS} = 20\text{ V}$			1.0	μA
Gate-to-Source Leakage Current	I_{GSS}	$V_{DS} = 0\text{ V}, V_{GS} = \pm 10\text{ V}$			± 100	μA
ON CHARACTERISTICS (Note 2)						
Gate Threshold Voltage	$V_{GS(TH)}$	$V_{DS} = 3\text{ V}, I_D = 100\ \mu\text{A}$	0.5	1.0	1.5	V
Drain-to-Source On Resistance	$R_{DS(on)}$	$V_{GS} = 4.5\text{ V}, I_D = 10\text{ mA}$		1.5	3.0	Ω
		$V_{GS} = 2.5\text{ V}, I_D = 10\text{ mA}$		2.2	3.5	
Forward Transconductance	g_{FS}	$V_{DS} = 3\text{ V}, I_D = 10\text{ mA}$		50		mS
CAPACITANCES						
Input Capacitance	C_{ISS}	$V_{DS} = 5\text{ V}, f = 1\text{ MHz}, V_{GS} = 0\text{ V}$		11.5	20	μF
Output Capacitance	C_{OSS}			10	15	
Reverse Transfer Capacitance	C_{RSS}			3.5	6.0	
SWITCHING CHARACTERISTICS (Note 3)						
Turn-On Delay Time	$t_{d(ON)}$	$V_{GS} = 4.5\text{ V}, V_{DS} = 5\text{ V}, I_D = 10\text{ mA}, R_G = 10\ \Omega$		13		ns
Rise Time	t_r			15		
Turn-Off Delay Time	$t_{d(OFF)}$			98		
Fall Time	t_f			60		
DRAIN-SOURCE DIODE CHARACTERISTICS						
Forward Diode Voltage	V_{SD}	$V_{GS} = 0\text{ V}, I_S = 10\text{ mA}$		0.66	0.8	V

 2. Pulse Test: pulse width $\leq 300\ \mu\text{s}$, duty cycle $\leq 2\%$.

3. Switching characteristics are independent of operating junction temperatures.

LNTA4001NT1G

TYPICAL PERFORMANCE CURVES

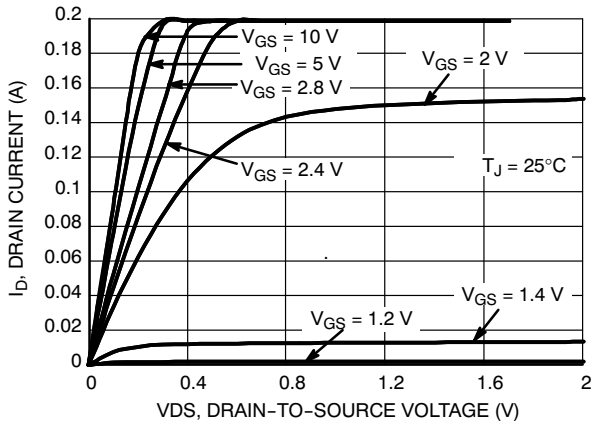

Figure 1. On-region Characteristics

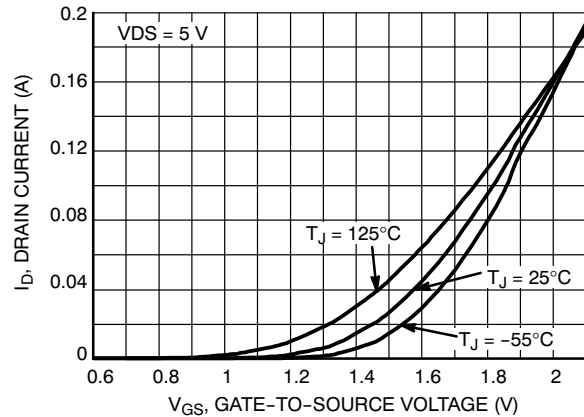

Figure 2. Transfer Characteristics

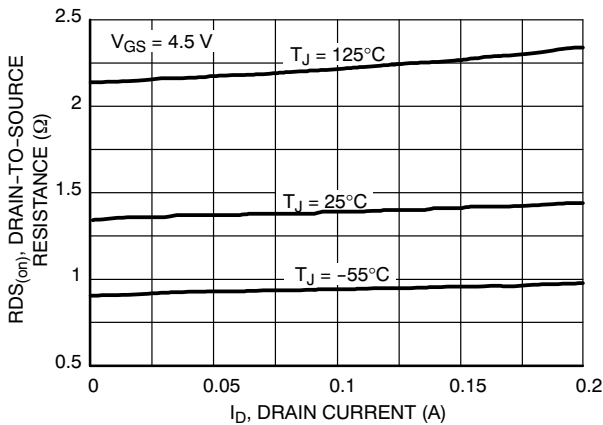

Figure 3. On-resistance versus Drain Current and Temperature

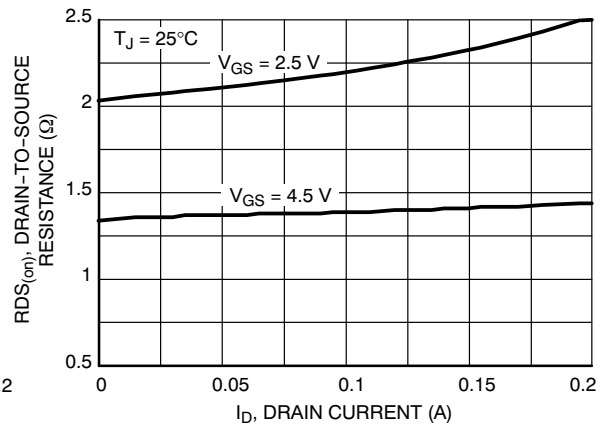

Figure 4. On-resistance versus Drain Current and Gate Voltage

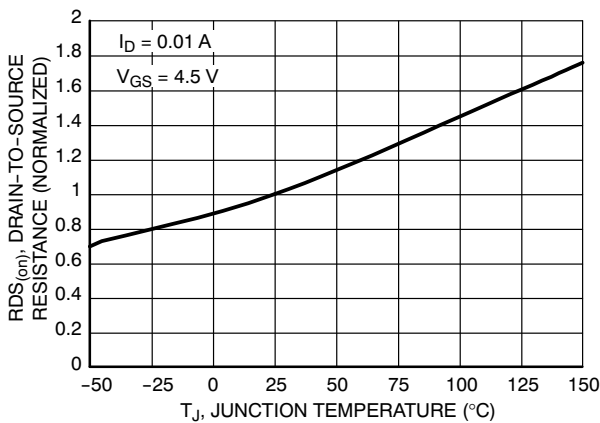

Figure 5. On-resistance Variation with Temperature

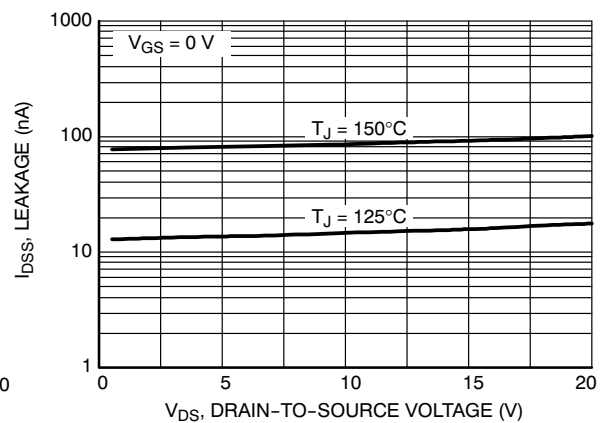

Figure 6. Drain-to-Source Leakage Current versus Voltage

TYPICAL PERFORMANCE CURVES

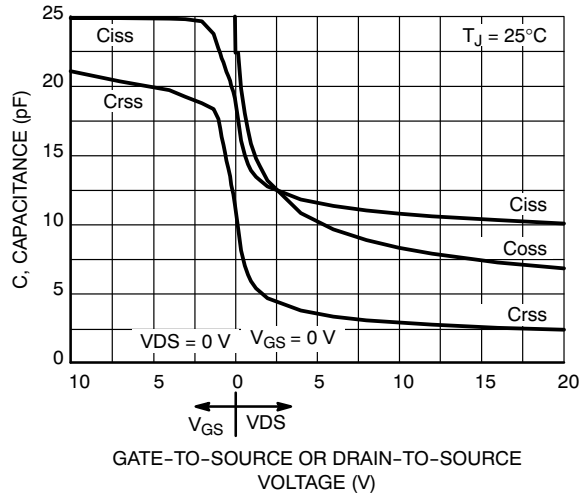

Figure 7. Capacitance Variation

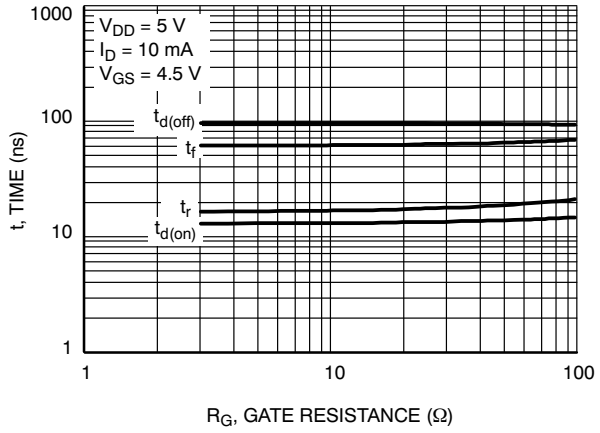

Figure 8. Resistive Switching Time Variation versus Gate Resistance

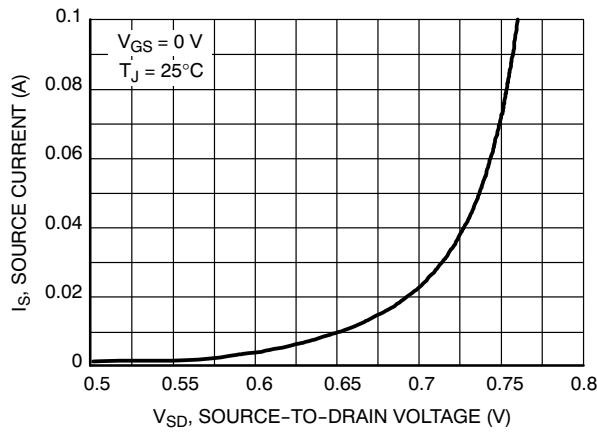
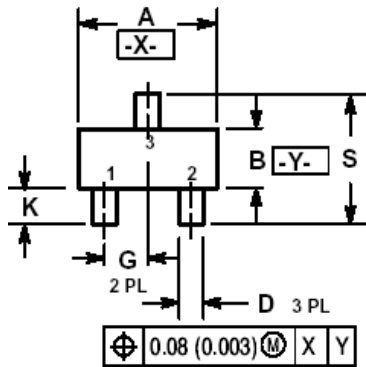

Figure 9. Diode Forward Voltage versus Current

LNTA4001NT1G

SC-89



NOTES:

1. DIMENSIONING AND TOLERANCING PER ANSI Y14.5M, 1982.
2. CONTROLLING DIMENSION: MILLIMETERS
3. MAXIMUM LEAD THICKNESS INCLUDES LEAD FINISH THICKNESS. MINIMUM LEAD THICKNESS IS THE MINIMUM THICKNESS OF BASE MATERIAL.
4. 463C-01 OBSOLETE, NEW STANDARD 463C-02.

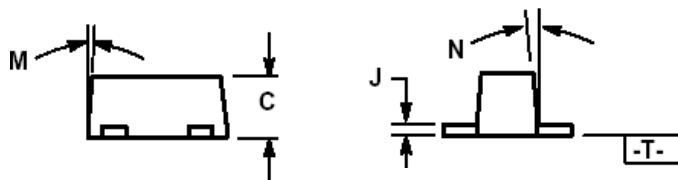

DIM	MILLIMETERS			INCHES		
	MIN	NOM	MAX	MIN	NOM	MAX
A	1.50	1.60	1.70	0.059	0.063	0.067
B	0.75	0.85	0.95	0.030	0.034	0.040
C	0.60	0.70	0.80	0.024	0.028	0.031
D	0.23	0.28	0.33	0.009	0.011	0.013
G	0.50 BSC			0.020 BSC		
H	0.53 REF			0.021 REF		
J	0.10	0.15	0.20	0.004	0.006	0.008
K	0.30	0.40	0.50	0.012	0.016	0.020
L	1.10 REF			0.043 REF		
M	---	---	10 °	---	---	10 °
N	---	---	10 °	---	---	10 °
S	1.50	1.60	1.70	0.059	0.063	0.067

