

To all our customers

Regarding the change of names mentioned in the document, such as Hitachi Electric and Hitachi XX, to Renesas Technology Corp.

The semiconductor operations of Mitsubishi Electric and Hitachi were transferred to Renesas Technology Corporation on April 1st 2003. These operations include microcomputer, logic, analog and discrete devices, and memory chips other than DRAMs (flash memory, SRAMs etc.) Accordingly, although Hitachi, Hitachi, Ltd., Hitachi Semiconductors, and other Hitachi brand names are mentioned in the document, these names have in fact all been changed to Renesas Technology Corp. Thank you for your understanding. Except for our corporate trademark, logo and corporate statement, no changes whatsoever have been made to the contents of the document, and these changes do not constitute any alteration to the contents of the document itself.

Renesas Technology Home Page: <http://www.renesas.com>

Renesas Technology Corp.
Customer Support Dept.
April 1, 2003

Cautions

Keep safety first in your circuit designs!

1. Renesas Technology Corporation puts the maximum effort into making semiconductor products better and more reliable, but there is always the possibility that trouble may occur with them. Trouble with semiconductors may lead to personal injury, fire or property damage.

Remember to give due consideration to safety when making your circuit designs, with appropriate measures such as (i) placement of substitutive, auxiliary circuits, (ii) use of nonflammable material or (iii) prevention against any malfunction or mishap.

Notes regarding these materials

1. These materials are intended as a reference to assist our customers in the selection of the Renesas Technology Corporation product best suited to the customer's application; they do not convey any license under any intellectual property rights, or any other rights, belonging to Renesas Technology Corporation or a third party.
2. Renesas Technology Corporation assumes no responsibility for any damage, or infringement of any third-party's rights, originating in the use of any product data, diagrams, charts, programs, algorithms, or circuit application examples contained in these materials.
3. All information contained in these materials, including product data, diagrams, charts, programs and algorithms represents information on products at the time of publication of these materials, and are subject to change by Renesas Technology Corporation without notice due to product improvements or other reasons. It is therefore recommended that customers contact Renesas Technology Corporation or an authorized Renesas Technology Corporation product distributor for the latest product information before purchasing a product listed herein.
The information described here may contain technical inaccuracies or typographical errors. Renesas Technology Corporation assumes no responsibility for any damage, liability, or other loss rising from these inaccuracies or errors.
Please also pay attention to information published by Renesas Technology Corporation by various means, including the Renesas Technology Corporation Semiconductor home page (<http://www.renesas.com>).
4. When using any or all of the information contained in these materials, including product data, diagrams, charts, programs, and algorithms, please be sure to evaluate all information as a total system before making a final decision on the applicability of the information and products. Renesas Technology Corporation assumes no responsibility for any damage, liability or other loss resulting from the information contained herein.
5. Renesas Technology Corporation semiconductors are not designed or manufactured for use in a device or system that is used under circumstances in which human life is potentially at stake. Please contact Renesas Technology Corporation or an authorized Renesas Technology Corporation product distributor when considering the use of a product contained herein for any specific purposes, such as apparatus or systems for transportation, vehicular, medical, aerospace, nuclear, or undersea repeater use.
6. The prior written approval of Renesas Technology Corporation is necessary to reprint or reproduce in whole or in part these materials.
7. If these products or technologies are subject to the Japanese export control restrictions, they must be exported under a license from the Japanese government and cannot be imported into a country other than the approved destination.
Any diversion or reexport contrary to the export control laws and regulations of Japan and/or the country of destination is prohibited.
8. Please contact Renesas Technology Corporation for further details on these materials or the products contained therein.

PF08127B

MOS FET Power Amplifier Module
for E-GSM and DCS1800/1900 Triple Band Handy Phone

RENESAS

ADE-208-1606 (Z)

Rev.0
Oct. 2002

Application

- Triple band amplifier for
E-GSM (880 MHz to 915 MHz), DCS1800/1900 (1710 MHz to 1785 MHz, 1850 MHz to 1910 MHz).
- For 3.5 V & GPRS Class12 operation compatible

Features

- All in one including output matching circuit
- Simple external circuit
- Simple power control
- High gain 3stage amplifier : 0 dBm input Typ
- Lead less thin & Small package : 8.0 × 10.0 mm Typ × 1.5 mm Max
- High efficiency : 55% Typ at 35.0 dBm for E-GSM
47% Typ at 32.5 dBm for DCS1800
47% Typ at 32.0 dBm for DCS1900

Pin Arrangement

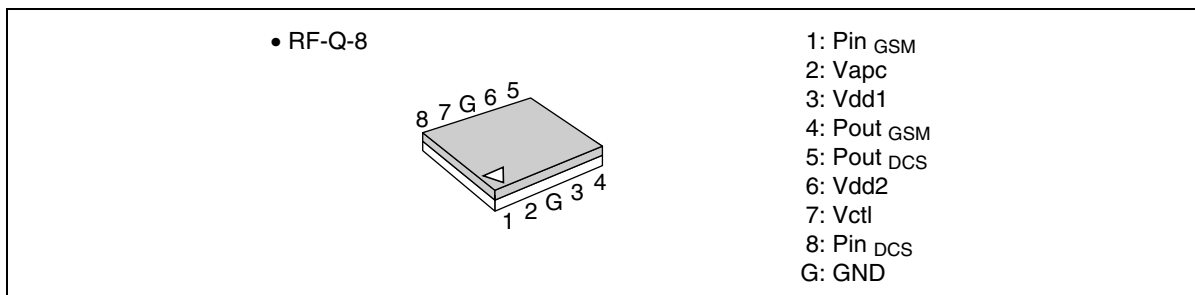

PF08127B

Absolute Maximum Ratings *¹

(T_c = 25°C)

Item	Symbol	Rating	Unit	Remark
Supply voltage	V _{dd}	7.0	V	at no-operation
		5.0	V	at operation (50 Ω load)
Supply current	I _{dd} _{GSM}	3.5	A	
	I _{dd} _{DCS}	2	A	
V _{ctl} voltage	V _{ctl}	4	V	
V _{apc} voltage	V _{apc}	4	V	
Input power	P _{in}	10	dBm	
Operating case temperature * ²	T _c (op)	-30 to +100	°C	
Storage temperature	T _{stg}	-40 to +100	°C	
Output power	P _{out} _{GSM}	5	W	
	P _{out} _{DCS}	3	W	

- Notes: 1. The maximum ratings shall be valid over both the E-GSM-band (880 to 915 MHz), and the DCS1800/1900-band (1710 to 1785 MHz, 1850 to 1910 MHz).
2. These are specified at pulsed operation with pulse width = 1154 μsec and duty cycle of 2:8.

Electrical Characteristics for DC

(T_c = 25°C)

Item	Symbol	Min	Typ	Max	Unit	Test Condition
Drain cutoff current	I _{ds}	—	—	20	μA	V _{dd} = 4.7 V, V _{apc} = 0 V, V _{ctl} = 0.2 V
V _{apc} control current	I _{apc}	—	—	2.0	mA	V _{apc} = 2.2 V
V _{ctl} control current	I _{ctl}	—	—	2	μA	V _{ctl} = 3 V

Electrical Characteristics for E-GSM band

(Tc = 25°C)

Test conditions unless otherwise noted:

f = 880 to 915 MHz, Vdd1 = Vdd2 = 3.5 V, Pin = 0 dBm, Vctl = 2.0 V, Rg = Rl = 50 Ω, Tc = 25°C, Pulse operation with pulse width 1154 μs and duty cycle 2:8 shall be used.

Item	Symbol	Min	Typ	Max	Unit	Test Condition
Frequency range	f	880	—	915	MHz	
Band select (GSM active)	Vctl	2.0	—	2.8	V	
Input power	Pin	-2	0	2	dBm	
Control voltage range	Vapc	0.2	—	2.2	V	
Supply voltage	Vdd	3.1	3.5	4.5	V	
Total efficiency	η_T	47	55	—	%	Pout _{GSM} = 35 dBm, Vapc = controlled
2nd harmonic distortion	2nd H.D.	—	-15(-50)	0(-35)	dBm(dBc)	
3rd harmonic distortion	3rd H.D.	—	-10(-45)	0(-35)	dBm(dBc)	
4th~8th harmonic distortion	4th~8th H.D.	—	—	0(-35)	dBm(dBc)	
Input VSWR	VSWR (in)	—	1.5	3	—	
Output power (1)	Pout (1)	35.0	36.0	—	dBm	Vapc = 2.2 V
Output power (2)	Pout (2)	33.5	34.5	—	dBm	Vdd = 3.1 V, Vapc = 2.2 V, Tc = +85°C
Idd at Low power	—	—	—	300	mA	Pout _{GSM} = 7 dBm
Isolation	—	—	-48	-37	dBm	Vapc = 0.2 V
Isolation at DCS RF-output when GSM is active	—	—	-25	-18	dBm	Pout _{GSM} = 35 dBm, Measured at f = 1760 to 1830 MHz
Switching time	t _r , t _f	—	1	2	μs	Pout _{GSM} = 5 to 35 dBm
Stability	—	No parasitic oscillation > -36 dBm			—	Vdd = 3.1 to 4.5 V, Pout ≤ 35 dBm, Vapc _{GSM} ≤ 2.2 V, Rg = 50 Ω, Output VSWR = 6 : 1 All phase angles
Load VSWR tolerance	—	No degradation or Permanent degradation			—	Vdd = 3.1 to 4.5 V, Pout _{GSM} ≤ 35 dBm, Vapc _{GSM} ≤ 2.2 V, Rg = 50 Ω, t ≤ 20 sec., Output VSWR = 10 : 1 All phase angles
Load VSWR tolerance at GPRS CLASS 12 operation	—	No degradation or Permanent degradation			—	Vdd = 3.1 to 4.2 V, Pout _{GSM} ≤ 35 dBm, Vapc _{GSM} ≤ 2.2 V, Rg = 50 Ω, t ≤ 20 sec., Tc ≤ 90°C, Output VSWR = 10 : 1 All phase angles
Slope Pout/Vapc	—	—	160	200	dB/V	Pout _{GSM} = 5 to 35 dBm
AM output	—	—	15	20	%	Pout _{GSM} = 5 to 35 dBm, 4% AM modulation at input 50 kHz modulation frequency

PF08127B

Electrical Characteristics for DCS1800 band

(Tc = 25°C)

Test conditions unless otherwise noted:

f = 1710 to 1785 MHz, Vdd1 = Vdd2 = 3.5 V, Pin = 0 dBm, Vctl = 0 V, Rg = Rl = 50 Ω, Tc = 25°C, Pulse operation with pulse width 1154 μs and duty cycle 2:8 shall be used.

Item	Symbol	Min	Typ	Max	Unit	Test Condition
Frequency range	f	1710	—	1785	MHz	
Band select (DCS active)	Vctl	0	—	0.1	V	
Input power	Pin	-2	0	2	dBm	
Control voltage range	Vapc	0.2	—	2.2	V	
Supply voltage	Vdd	3.1	3.5	4.5	V	
Total efficiency	η_T	40	47	—	%	Pout _{DCS} = 32.5 dBm, Vapc = controlled
2nd harmonic distortion	2nd H.D.	—	-14.5(-47)	-2.5(-35)	dBm(dBc)	
3rd harmonic distortion	3rd H.D.	—	-7.5(-40)	-2.5(-35)	dBm(dBc)	
4th~8th harmonic distortion	4th~8th H.D.	—	—	-2.5(-35)	dBm(dBc)	
Input VSWR	VSWR (in)	—	1.5	3	—	
Output power (1)	Pout (1)	32.5	33.5	—	dBm	Vapc = 2.2 V
Output power (2)	Pout (2)	31.0	32.0	—	dBm	Vdd = 3.1 V, Vapc = 2.2 V, Tc = +85°C,
Idd at Low power	—	—	—	150	mA	Pout _{DCS} = 5 dBm
Isolation	—	—	-42	-37	dBm	Vapc = 0.2 V
Switching time	t _r , t _f	—	1	2	μs	Pout _{DCS} = 0 to 32.5 dBm
Stability	—	No parasitic oscillation > -36 dBm			—	Vdd = 3.1 to 4.5 V, Pout _{DCS} ≤ 32.5 dBm, Vapc ≤ 2.2 V, Rg = 50 Ω, Output VSWR = 6 : 1 All phase angles
Load VSWR tolerance	—	No degradation or Permanent degradation			—	Vdd = 3.1 to 4.5 V, Pout _{DCS} ≤ 32.5 dBm, Vapc ≤ 2.2 V, Rg = 50 Ω, t ≤ 20 sec., Output VSWR = 10 : 1 All phase angles
Load VSWR tolerance at GPRS CLASS 12 operation	—	No degradation or Permanent degradation			—	Vdd = 3.1 to 4.2 V, Pout _{DCS} ≤ 32.5 dBm, Vapc ≤ 2.2 V, Rg = 50 Ω, t ≤ 20 sec., Tc ≤ 90°C, Output VSWR = 10 : 1 All phase angles
Slope Pout/Vapc	—	—	160	200	dB/V	Pout _{DCS} = 0 to 32.5 dBm
AM output	—	—	15	20	%	Pout _{DCS} = 0 to 32.5 dBm, 4% AM modulation at input 50 kHz modulation frequency

Electrical Characteristics for DCS1900 band

(Tc = 25°C)

Test conditions unless otherwise noted:

f = 1850 to 1910 MHz, Vdd1 = Vdd2 = 3.5 V, Pin = 0 dBm, Vctl = 0.2 V, Rg = RI = 50 Ω, Tc = 25°C, Pulse operation with pulse width 1154 μs and duty cycle 2:8 shall be used.

Item	Symbol	Min	Typ	Max	Unit	Test Condition
Frequency range	f	1850	—	1910	MHz	
Band select (DCS active)	Vctl	0	—	0.1	V	
Input power	Pin	-2	0	2	dBm	
Control voltage range	Vapc	0.2	—	2.2	V	
Supply voltage	Vdd	3.1	3.5	4.5	V	
Total efficiency	η_T	40	47	—	%	Pout _{DCS} = 32.0 dBm, Vapc = controlled
2nd harmonic distortion	2nd H.D.	—	-15(-47)	-3(-35)	dBm(dBc)	
3rd harmonic distortion	3rd H.D.	—	-8(-40)	-3(-35)	dBm(dBc)	
4th~8th harmonic distortion	4th~8th H.D.	—	—	-3(-35)	dBm(dBc)	
Input VSWR	VSWR (in)	—	1.5	3	—	
Output power (1)	Pout (1)	32.0	33.0	—	dBm	Vapc = 2.2 V
Output power (2)	Pout (2)	30.5	31.5	—	dBm	Vdd = 3.1 V, Vapc = 2.2 V, Tc = +85°C
Idd at Low power	—	—	—	150	mA	Pout _{DCS} = 5 dBm
Isolation	—	—	-42	-37	dBm	Vapc = 0.2 V
Switching time	t _r , t _f	—	1	2	μs	Pout _{DCS} = 0 to 32.0 dBm
Stability	—	No parasitic oscillation > -36 dBm			—	Vdd = 3.1 to 4.5 V, Pout _{DCS} ≤ 32.0 dBm, Vapc ≤ 2.2 V, Rg = 50 Ω, Output VSWR = 6 : 1 All phase angles
Load VSWR tolerance	—	No degradation or Permanent degradation			—	Vdd = 3.1 to 4.5 V, Pout _{DCS} ≤ 32.0 dBm, Vapc ≤ 2.2 V, Rg = 50 Ω, t ≤ 20 sec., Output VSWR = 10 : 1 All phase angles
Load VSWR tolerance at GPRS CLASS 12 operation	—	No degradation or Permanent degradation			—	Vdd = 3.1 to 4.2 V, Pout _{DCS} ≤ 32.0 dBm, Vapc ≤ 2.2 V, Rg = 50 Ω, t ≤ 20 sec., Tc ≤ 90°C, Output VSWR = 10 : 1 All phase angles
Slope Pout/Vapc	—	—	160	200	dB/V	Pout _{DCS} = 0 to 32.0 dBm
AM output	—	—	15	20	%	Pout _{DCS} = 0 to 32.0 dBm, 4% AM modulation at input 50 kHz modulation frequency

PF08127B

Circuit Diagram

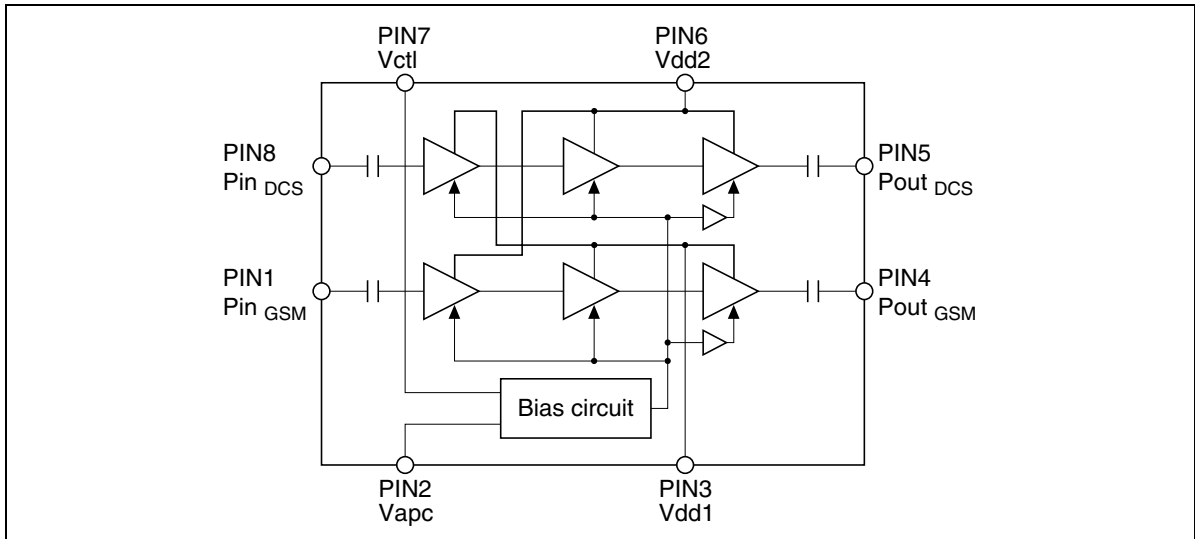

Characteristic Curves

GSM mode (880MHz to 915 MHz)

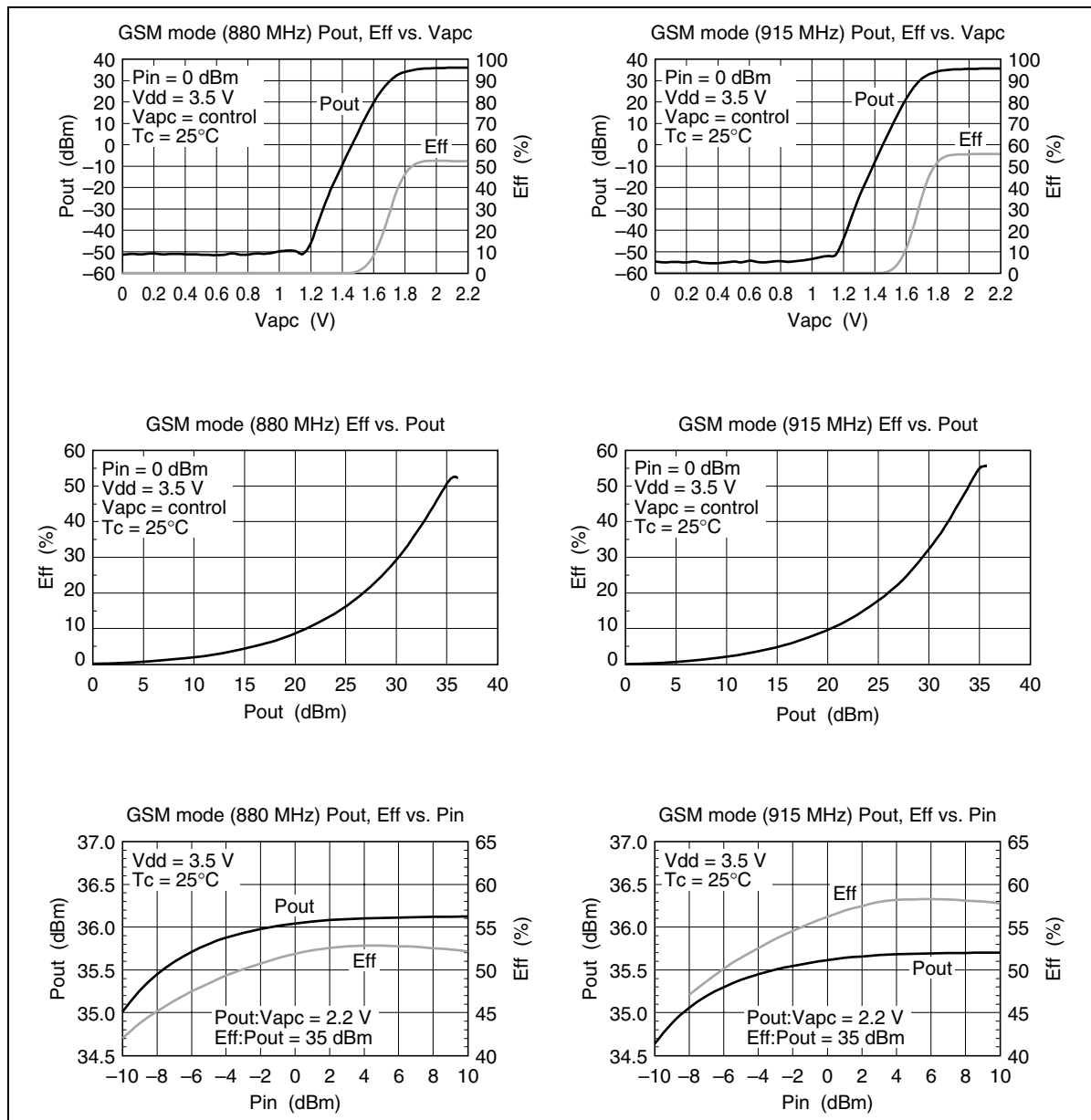

PF08127B

GSM mode (880MHz to 915 MHz) (cont.)

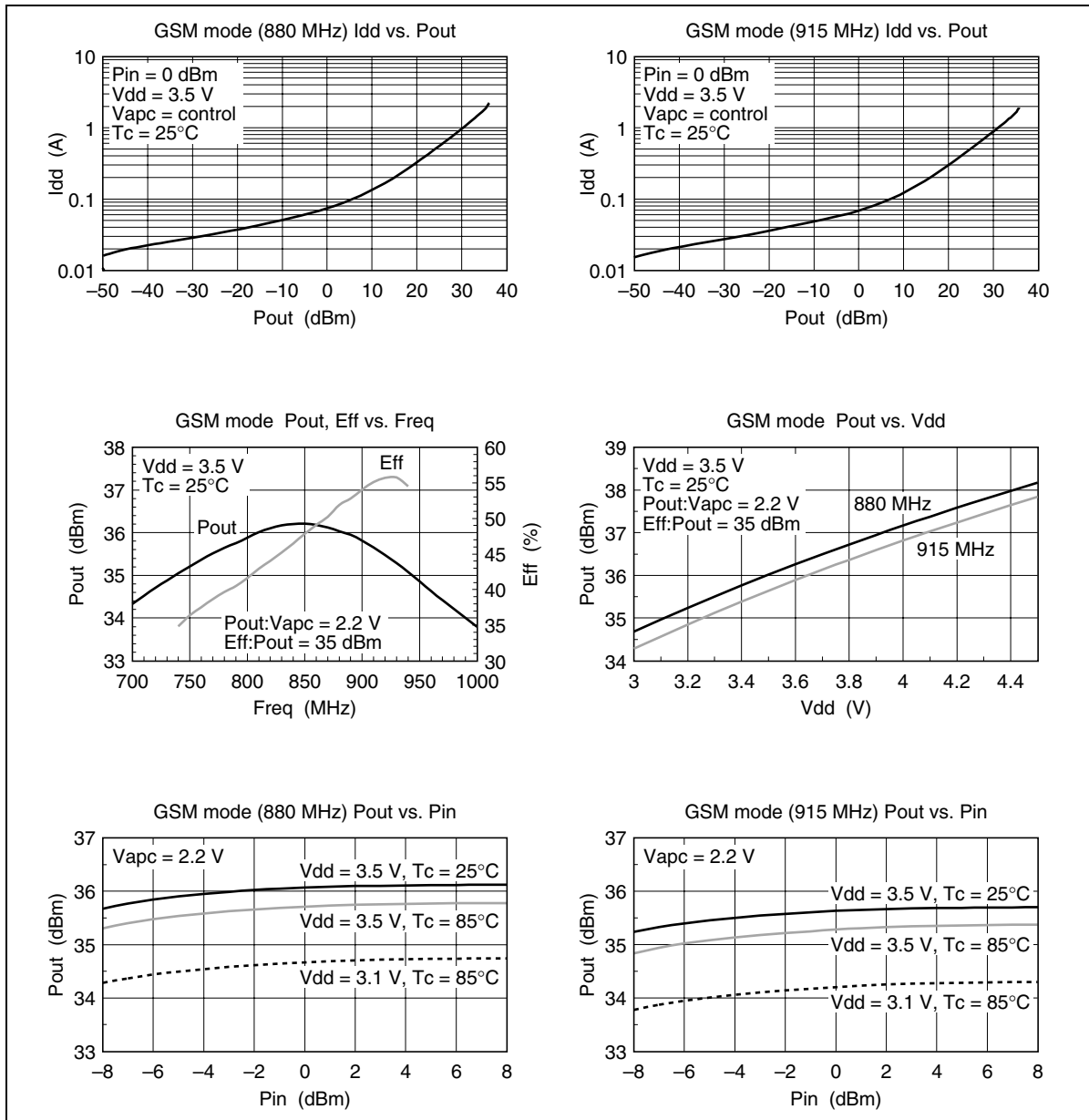

DCS mode (1710MHz to 1785 MHz)

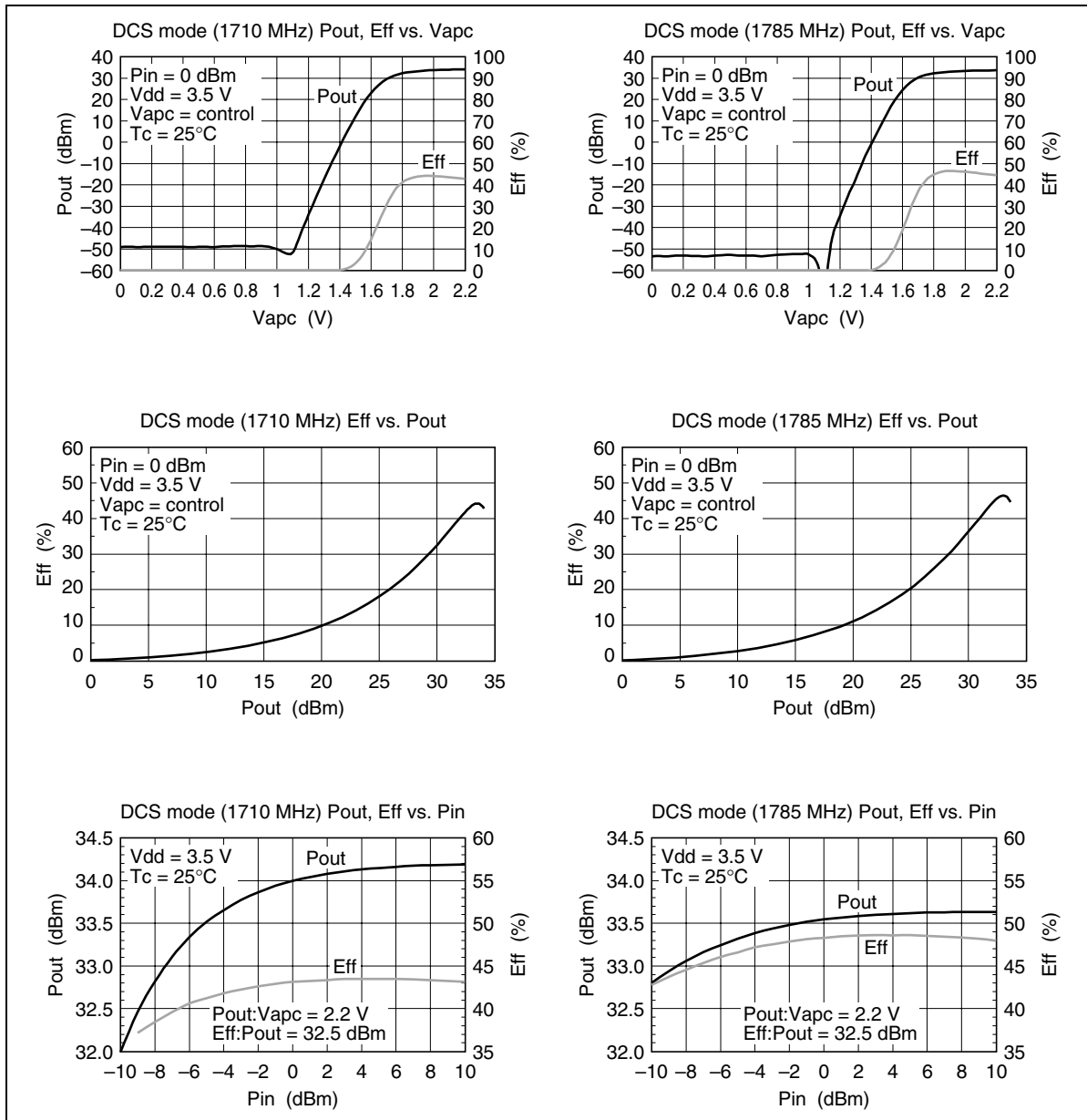

PF08127B

DCS mode (1710MHz to 1785 MHz) (cont.)

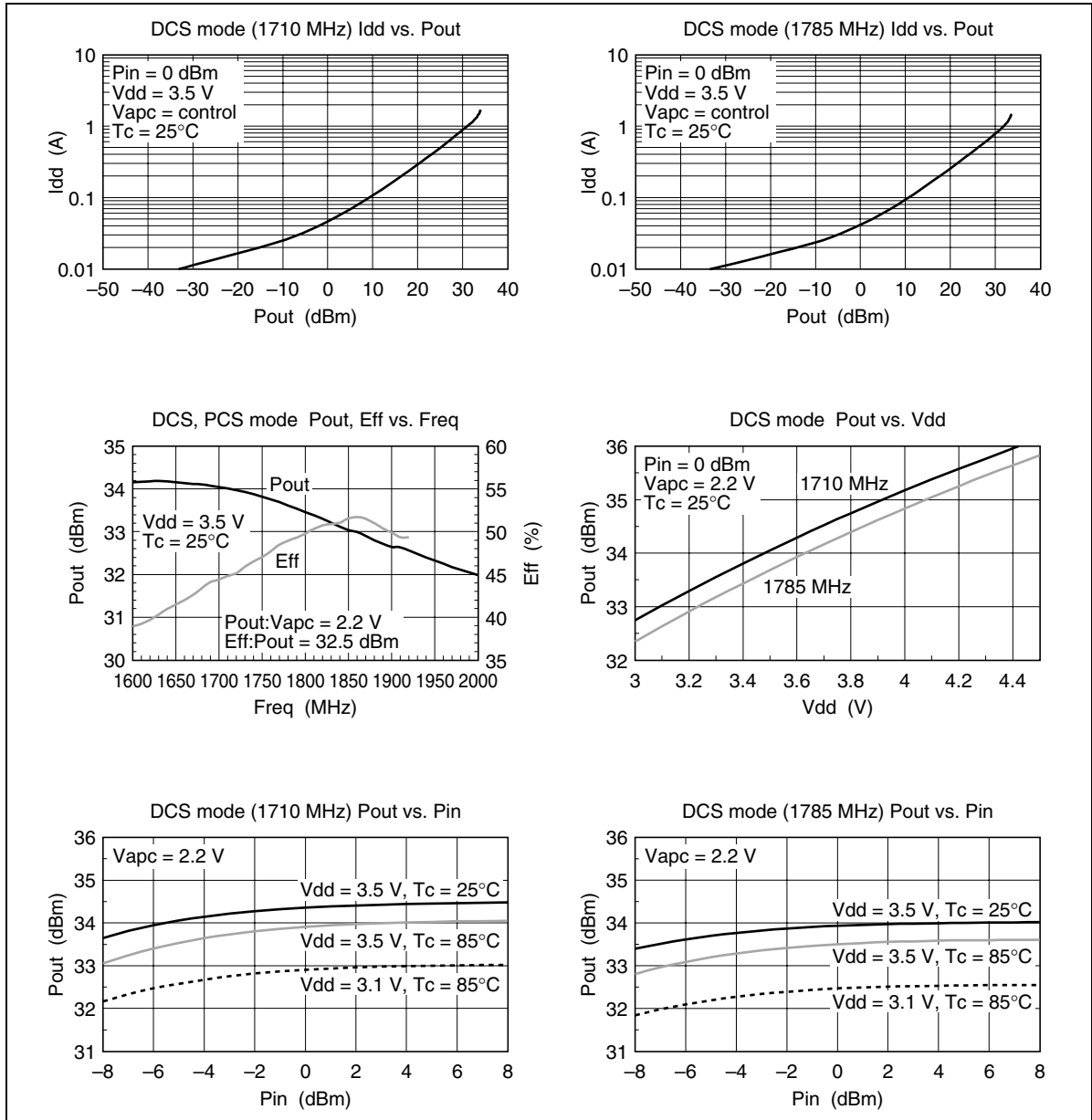

PCS mode (1850MHz to 1910 MHz)

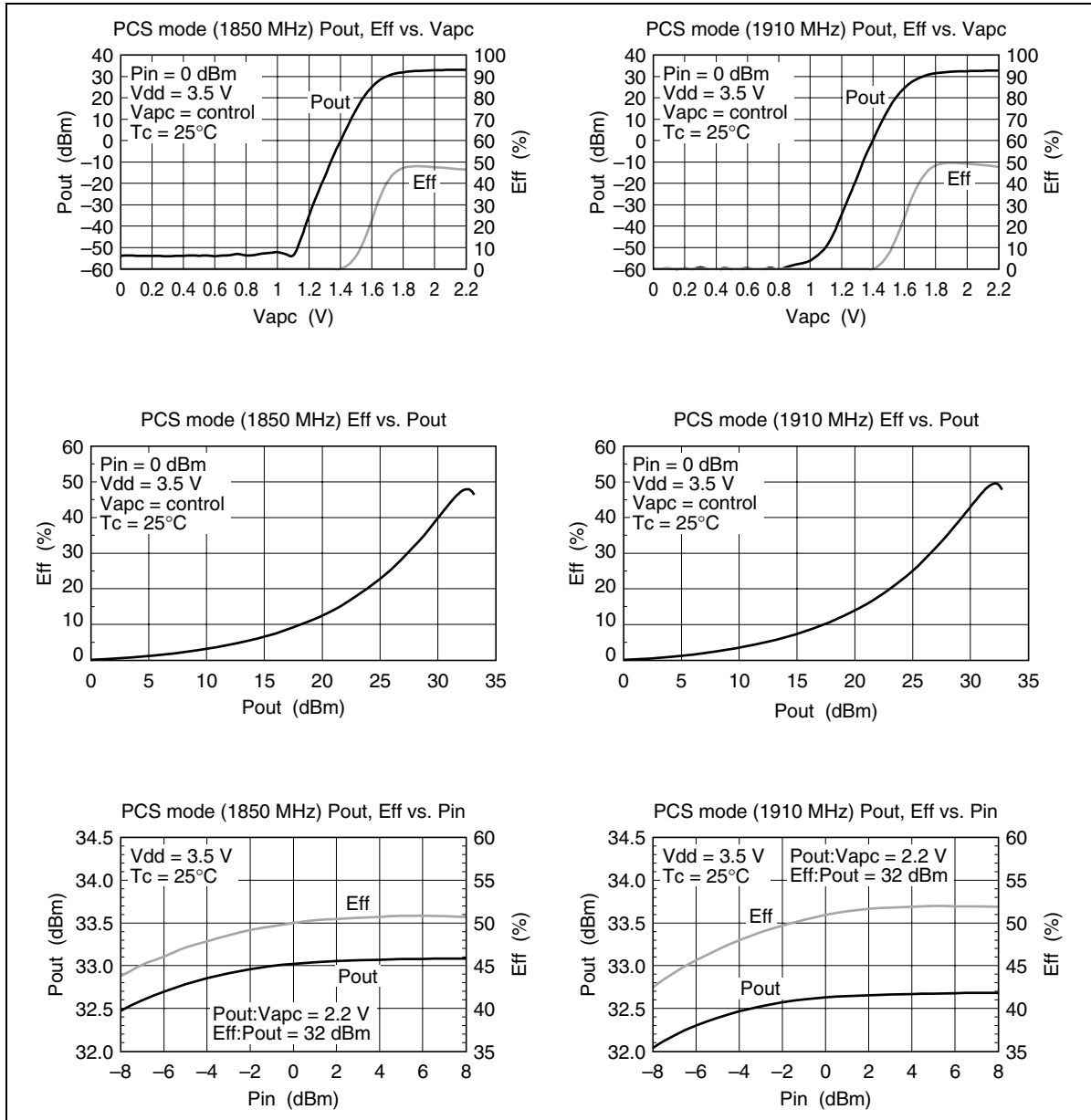

PF08127B

PCS mode (1850MHz to 1910 MHz) (cont.)

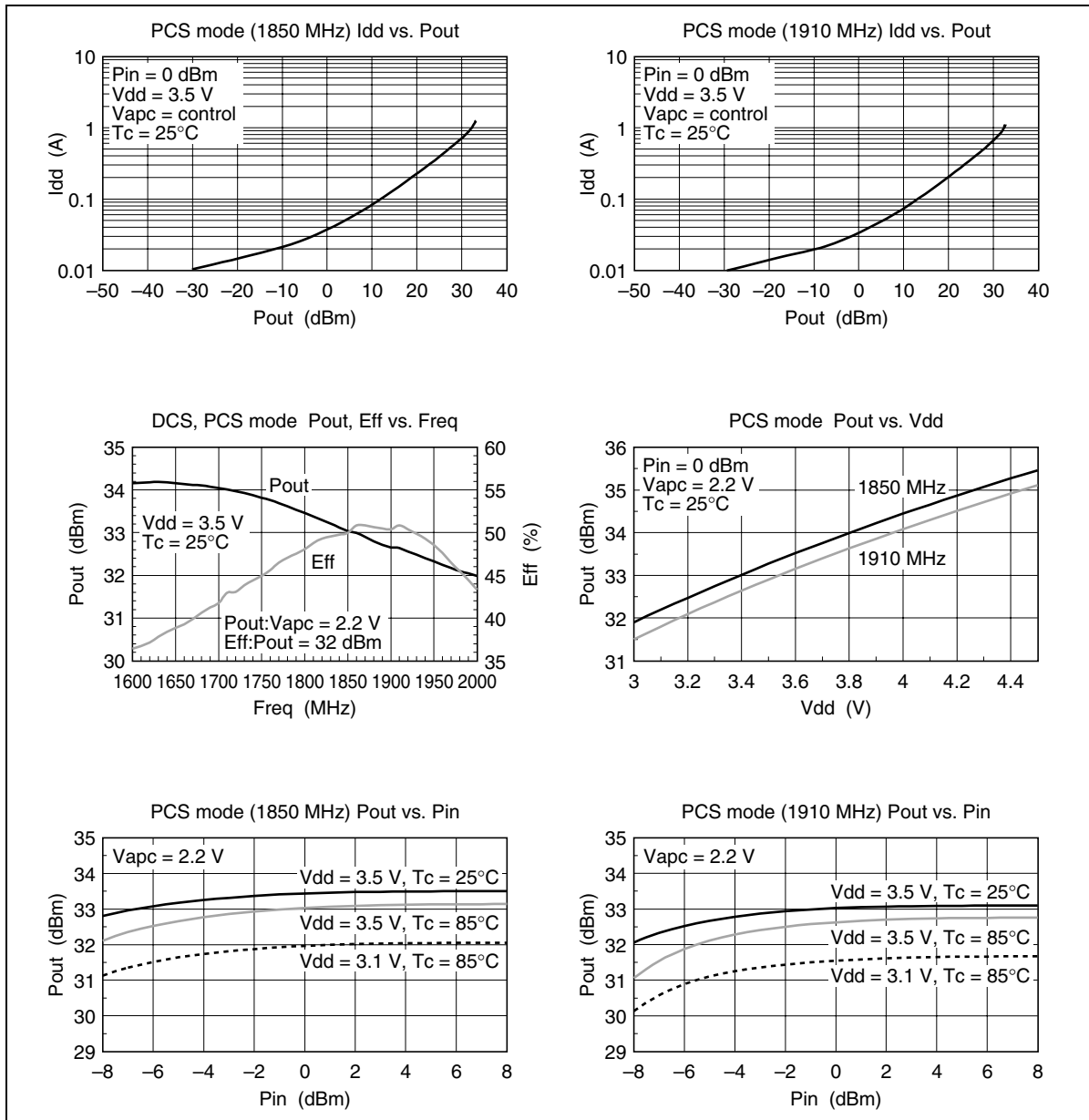

Package Dimensions

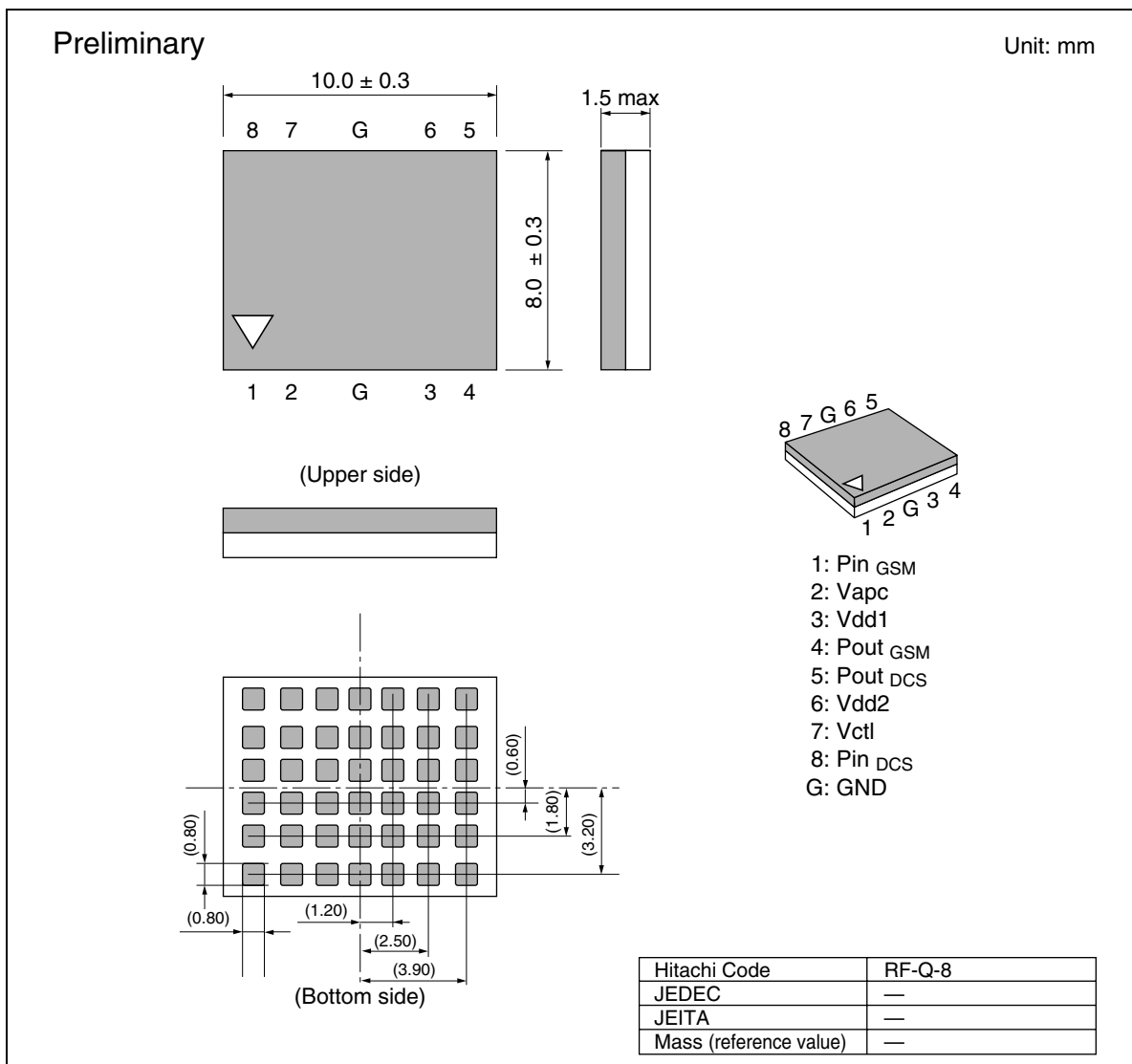

Renesas Technology Corp. Sales Strategic Planning Div. Nippon Bldg., 2-6-2, Ohte-machi, Chiyoda-ku, Tokyo 100-0004, Japan

Keep safety first in your circuit designs!

1. Renesas Technology Corporation puts the maximum effort into making semiconductor products better and more reliable, but there is always the possibility that trouble may occur with them. Trouble with semiconductors may lead to personal injury, fire or property damage.
Remember to give due consideration to safety when making your circuit designs, with appropriate measures such as (i) placement of substitutive, auxiliary circuits, (ii) use of nonflammable material or (iii) prevention against any malfunction or mishap.

Notes regarding these materials

1. These materials are intended as a reference to assist our customers in the selection of the Renesas Technology Corporation product best suited to the customer's application; they do not convey any license under any intellectual property rights, or any other rights, belonging to Renesas Technology Corporation or a third party.
 2. Renesas Technology Corporation assumes no responsibility for any damage, or infringement of any third-party's rights, originating in the use of any product data, diagrams, charts, programs, algorithms, or circuit application examples contained in these materials.
 3. All information contained in these materials, including product data, diagrams, charts, programs and algorithms represents information on products at the time of publication of these materials, and are subject to change by Renesas Technology Corporation without notice due to product improvements or other reasons. It is therefore recommended that customers contact Renesas Technology Corporation or an authorized Renesas Technology Corporation product distributor for the latest product information before purchasing a product listed herein.
The information described here may contain technical inaccuracies or typographical errors.
Renesas Technology Corporation assumes no responsibility for any damage, liability, or other loss rising from these inaccuracies or errors.
Please also pay attention to information published by Renesas Technology Corporation by various means, including the Renesas Technology Corporation Semiconductor home page (<http://www.renesas.com>).
 4. When using any or all of the information contained in these materials, including product data, diagrams, charts, programs, and algorithms, please be sure to evaluate all information as a total system before making a final decision on the applicability of the information and products. Renesas Technology Corporation assumes no responsibility for any damage, liability or other loss resulting from the information contained herein.
 5. Renesas Technology Corporation semiconductors are not designed or manufactured for use in a device or system that is used under circumstances in which human life is potentially at stake. Please contact Renesas Technology Corporation or an authorized Renesas Technology Corporation product distributor when considering the use of a product contained herein for any specific purposes, such as apparatus or systems for transportation, vehicular, medical, aerospace, nuclear, or undersea repeater use.
 6. The prior written approval of Renesas Technology Corporation is necessary to reprint or reproduce in whole or in part these materials.
 7. If these products or technologies are subject to the Japanese export control restrictions, they must be exported under a license from the Japanese government and cannot be imported into a country other than the approved destination.
Any diversion or reexport contrary to the export control laws and regulations of Japan and/or the country of destination is prohibited.
 8. Please contact Renesas Technology Corporation for further details on these materials or the products contained therein.
-



<http://www.renesas.com>



Copyright © 2003. Renesas Technology Corporation, All rights reserved. Printed in Japan.
Colophon 0.0