



\* Standard

# SPECIFICATION [SWAA0B]

SSC			Customer
Drawn by	Checked by	Approved by	Approved by
Semi Park	S.R. Ryu	H.J.HONG	
10/16	10/16	10/22	

Rev. 00

October, 2012

www.acrich.com



# Contents

1.	Description	-----	4
2.	Absolute Maximum Ratings	-----	5
3.	Electro-Optical Characteristics	-----	5
4.	Characteristic Diagram	-----	6
5.	Reliability Test	-----	9
6.	Color & Binning	-----	10
7.	Outline Dimension	-----	12
8.	Material List	-----	13
9.	Packing	-----	14
10.	Soldering	-----	16
11.	Precaution for use	-----	17



# SWAA0B

## SWAA0B

### 1. Description

- 1-chip in one package
- SMT solderability
- Own patent reserved
- RoHS Compliant
- Low Thermal Resistance
- Pb-free Reflow Soldering application
- SWAA0B is very useful side view LED in back light unit application



### Features

- 3.7 (W) X 0.9 (D) X 0.4 (T) mm
- Side View LED of Reflector type

### Applications

- Flat Backlighting (LCD, Display)
- Mobile Phone, Camera, PDA, Notebook
- Coupling into Light Guide Panel
- AV systems

## 2. Absolute maximum ratings

( $T_a = 25^\circ\text{C}$ )

Parameter	Symbol	Value	Unit
Power Dissipation	$P_d^{*1}$	102	mW
DC Forward Current	$I_F$	30	mA
Peak Forward Current	$I_{FM}^{*2}$	100	mA
Reverse Voltage	$V_R$	5	V
Operating Temperature	$T_{opr}$	-30 ~ +85	$^\circ\text{C}$
Storage Temperature	$T_{stg}$	-40 ~ +100	$^\circ\text{C}$
Junction Temperature	$T_j \text{ max}$	100	$^\circ\text{C}$

\*1 Care is to be taken that power dissipation does not exceed the absolute maximum rating of the product.

\*2  $I_{FM}$  was measured at  $T_w \leq 0.1$  msec of pulse width and  $D \leq 1/10$  of duty ratio.

## 3. Electro-Optical characteristics

( $T_a = 25^\circ\text{C}$ )

Parameter		Symbol	Condition	Min	Typ	Max	Unit
Forward Voltage	Rank Z28	$V_F$	$I_F = 20\text{mA}$	2.8	-	3.0	V
	Rank Z30			3.0	-	3.2	
	Rank Z32			3.2	-	3.4	
	Rank z30			3.0	-	3.4	
Reverse Current		$I_R$	$V_R = 5\text{V}$	-	-	50	$\mu\text{A}$
Luminous Intensity* <sup>1</sup>	Rank S15H	$I_V$	$I_F = 20\text{mA}$	1500	-	1600	mcd
	Rank S16H			1600	-	1700	
	Rank S17H			1700	-	1800	
	Rank S18H			1800	-	1900	
	Rank S19H			1900	-	2000	
	Rank S20H			2000	-	2100	
	Rank S21H			2100	-	2200	
Viewing Angle * <sup>2</sup>		$2\theta_{1/2}$	$I_F = 20\text{mA}$	120			deg.

\*<sup>1</sup> Luminous intensity  $I_V$  is measured at the peak of the spatial pattern which may not be aligned with the mechanical axis of the LED package. Luminous Intensity Measurement allowance is  $\pm 10\%$ .

\*<sup>2</sup>  $\theta_{1/2}$  is the off-axis where the luminous intensity is 1/2 of the peak intensity.

\* Tolerance of measurements of the Color Coordinates is  $\pm 0.007$

\* Tolerance of measurements of the Forward Voltage is  $\pm 0.1\text{V}$

\* The preliminary color coordinate can be changed without notice

\* Note : All products confirm to the listed minimum and maximum specifications for electric and optical characteristics, when operated at 20mA within the maximum ratings shown above.

All measurements were made under the standardized environment of Seoul Semiconductor.

Rev. 00

October, 2012

www.acrich.com

### 4. Characteristic Diagram

<p>Forward Current vs. Forward Voltage</p>	<p>Intensity vs. Forward Current</p>
<p><math>T_a = 25^\circ\text{C}</math></p>	<p><math>T_a = 25^\circ\text{C}</math></p>
<p>Color Coordinate vs. Forward Current</p>	<p>Radiation Diagram</p>
<p><math>T_a = 25^\circ\text{C}</math></p>	

Forward Voltage vs. Ambient Temperature

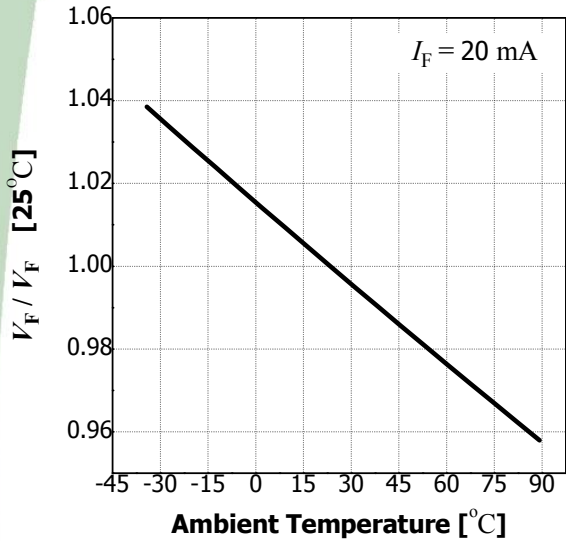

Relative Luminosity vs. Ambient Temperature

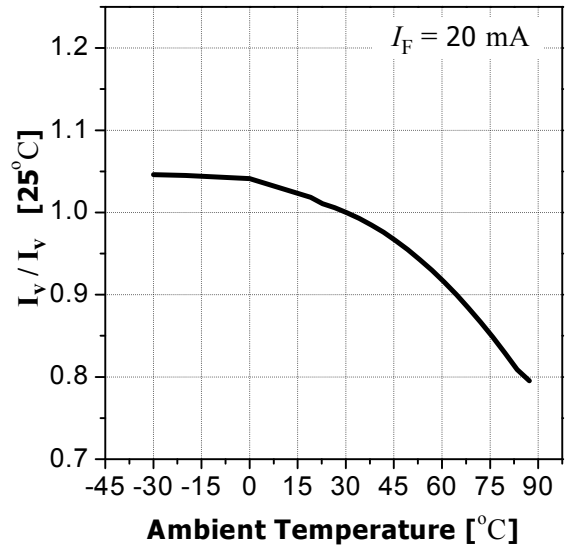

Color Coordinate vs. Ambient Temperature

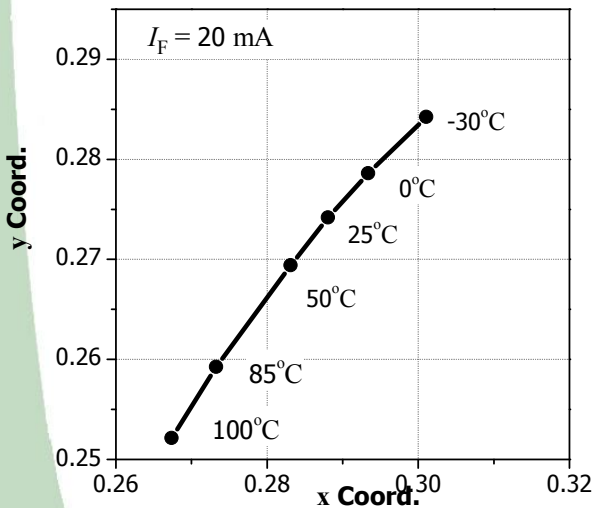

Spectrum

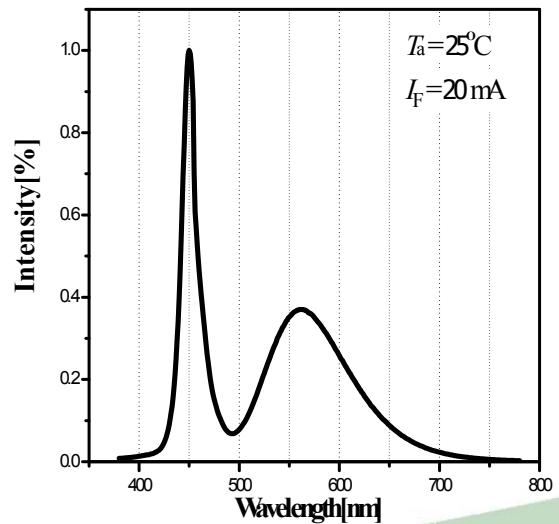

Allowable Forward Current vs. Ambient Temperature

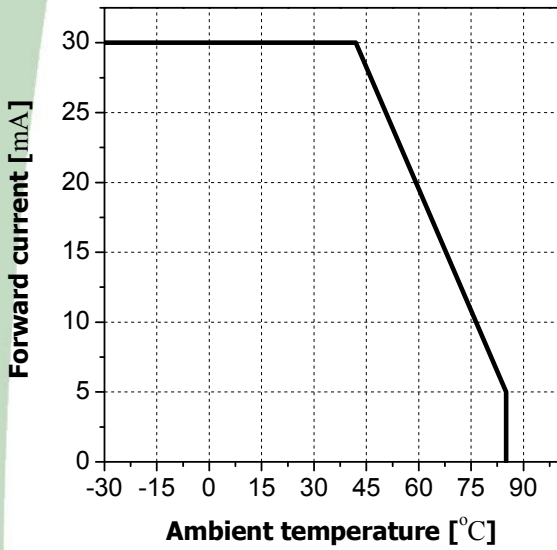

Allowable Forward Current vs. Duty Ratio

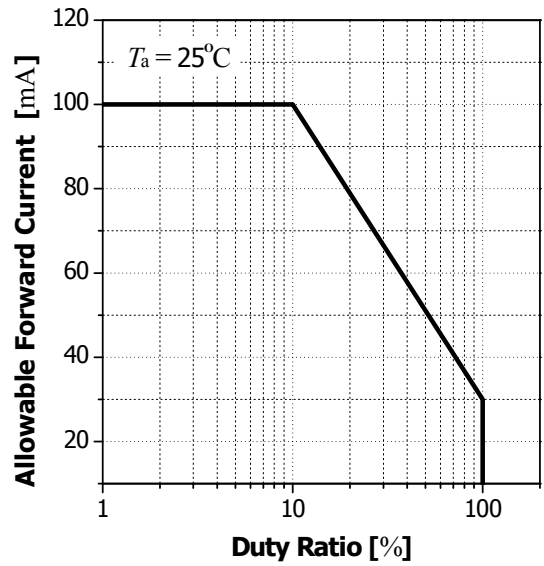



### 5. Reliability Test

\* TEST ITEMS AND RESULTS

Item	Reference	Test Condition	Duration / Cycle	Number of Damage
Life Test	-	$T_a = 25^{\circ}\text{C}, I_F = 20\text{mA}$	1,000 Hours	0/20
High Temperature Life Test	-	$T_a = 85^{\circ}\text{C}, I_F = 5\text{mA}$	1,000 Hours	0/20
Low Temperature Life Test	-	$T_a = -30^{\circ}\text{C}, I_F = 20\text{mA}$	1,000 Hours	0/20
High Humidity Heat Life Test	JEITA ED-4701 100 102	$T_a = 60^{\circ}\text{C}, \text{RH} = 90\%, I_F = 20\text{mA}$	500 Hours	0/20
High Temperature Storage	JEITA ED-4701 200 201	$T_a = 100^{\circ}\text{C}$	1,000 Hours	0/20
Low Temperature Storage	JEITA ED-4701 200 202	$T_a = -40^{\circ}\text{C}$	1,000 Hours	0/20
Temperature Cycle	JEITA ED-4701 100 105	$-40^{\circ}\text{C} \sim 25^{\circ}\text{C} \sim 100^{\circ}\text{C} \sim 25^{\circ}\text{C}$ (30min) (5min) (30min) (5min)	100 cycle	0/50

\* Criteria for Judging the Damage

Item	Symbol	Condition	Criteria for Judgement	
			MIN	MAX
Forward Voltage	$V_F$	$I_F = 20\text{mA}$	-	I.V. *1 × 1.2
Reverse Current	$I_R$	$V_R = 5\text{V}$	-	U.S.L. *2 × 2.0
Luminous Intensity	$I_V$	$I_F = 20\text{mA}$	I.V. × 0.7	-

Note : \*1 I.V. : Initial Value

\*2 U.S.L. : Upper Standard Level

Rev. 00

October, 2012

www.acrich.com

## 6. Color & Binning

\* CIE Chromaticity Diagram

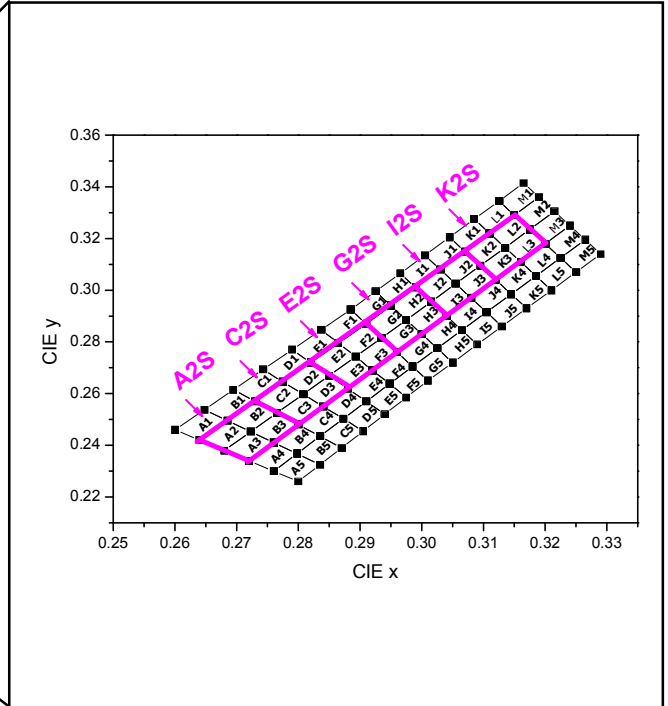
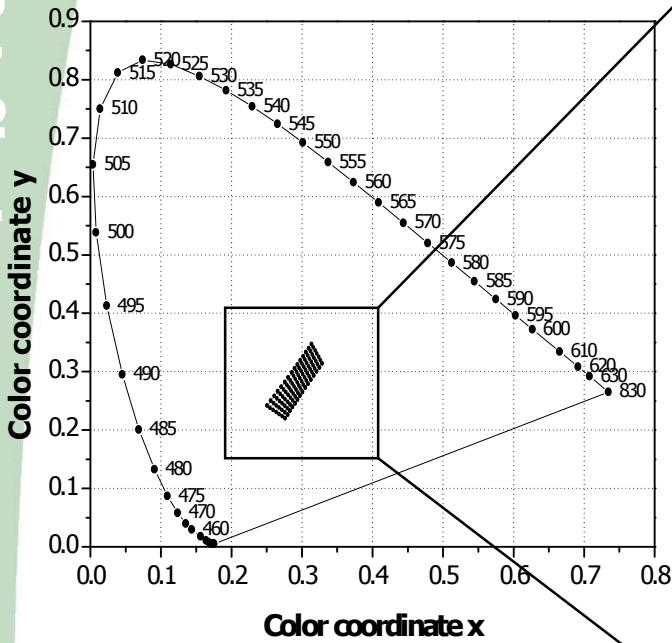

\* Color Rank

A2S		C2S		E2S	
x	y	x	y	x	y
0.2640	0.2420	0.2730	0.2570	0.2820	0.2720
0.2720	0.2340	0.2800	0.2480	0.2880	0.2620
0.2800	0.2480	0.2880	0.2620	0.2960	0.2760
0.2730	0.2570	0.2820	0.2720	0.2910	0.2870

G2S		I2S		K2S	
x	y	x	y	x	y
0.2910	0.2870	0.2990	0.3010	0.3070	0.3150
0.2960	0.2760	0.3040	0.2900	0.3120	0.3040
0.3040	0.2900	0.3120	0.3040	0.3200	0.3180
0.2990	0.3010	0.3070	0.3150	0.3150	0.3290

\* Measurement Uncertainty of the Color Coordinates is  $\pm 0.007$

\* Bin Code description

▷ Part Number : SWAA0B

Bin Code		
Luminous Intensity	CIE	Forward Voltage
S18H	E2S	z30

Luminous Intensity(mcd) @ $I_F = 20\text{mA}$		
Bin Code	Min.	Max.
S15H	1500	1600
S16H	1600	1700
S17H	1700	1800
S18H	1800	1900
S19H	1900	2000
S20H	2000	2100
S21H	2100	2200

Color Rank @ $I_F = 20\text{mA}$
A2S
C2S
E2S
G2S
I2S
K2S

Forward Voltage (V) @ $I_F = 20\text{mA}$		
Bin Code	Min.	Max.
Z28	2.8	3.0
Z30	3.0	3.2
Z32	3.2	3.4
z30	3.0	3.4

□ Available ranks

7. Outline Dimension

( Tolerance:  $\pm 0.1$ , Unit: mm )

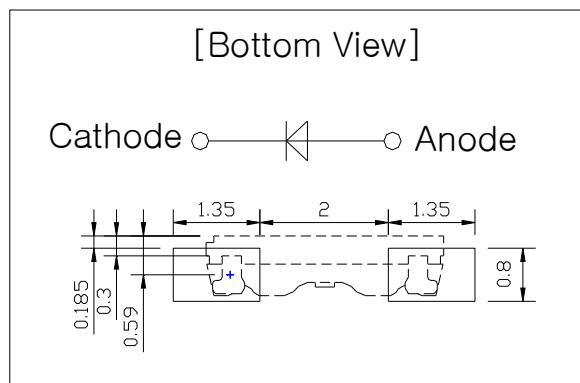
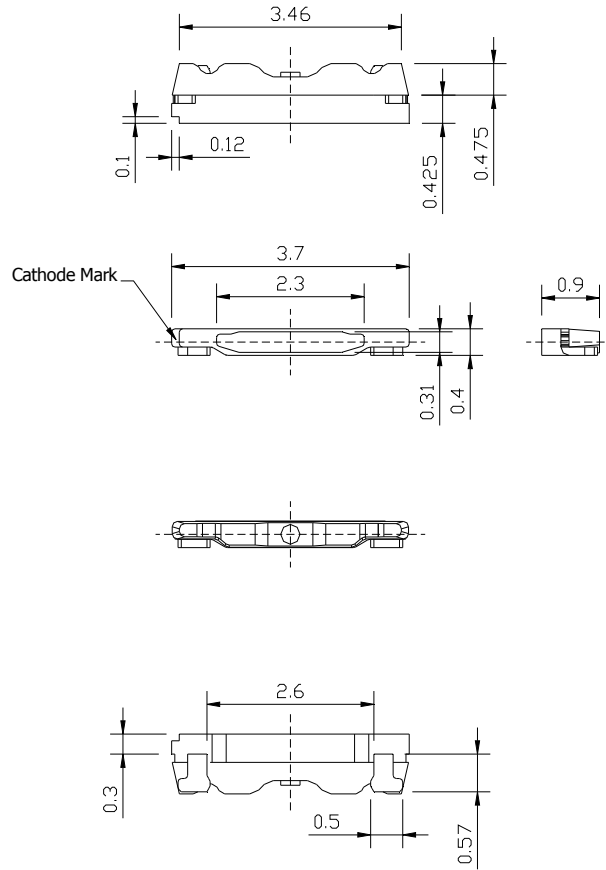

<Recommended solder Pattern>

8. Material

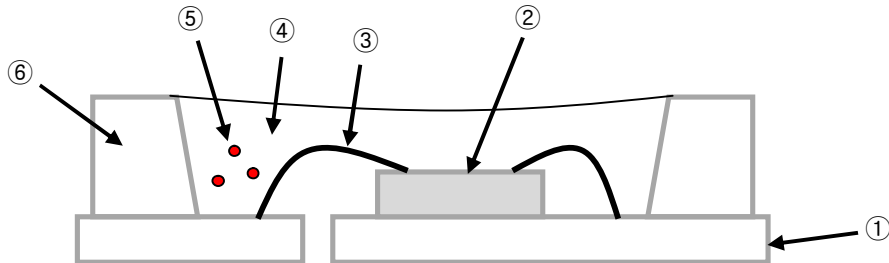

No.	LIST	MATERIAL
①	FRAME	COPPER FRAME (SILVER PLATED)
②	LED CHIP	GaN ON SAPPHIRE
③	WIRE	GOLD WIRE
④	ENCAPSULATION	SILICONE
⑤	PHOSPHOR	SILICATE
⑥	PACKAGE	HEAT-RESISTANT POLYMER

## 9. Packing

### 1) Reel & Carrier

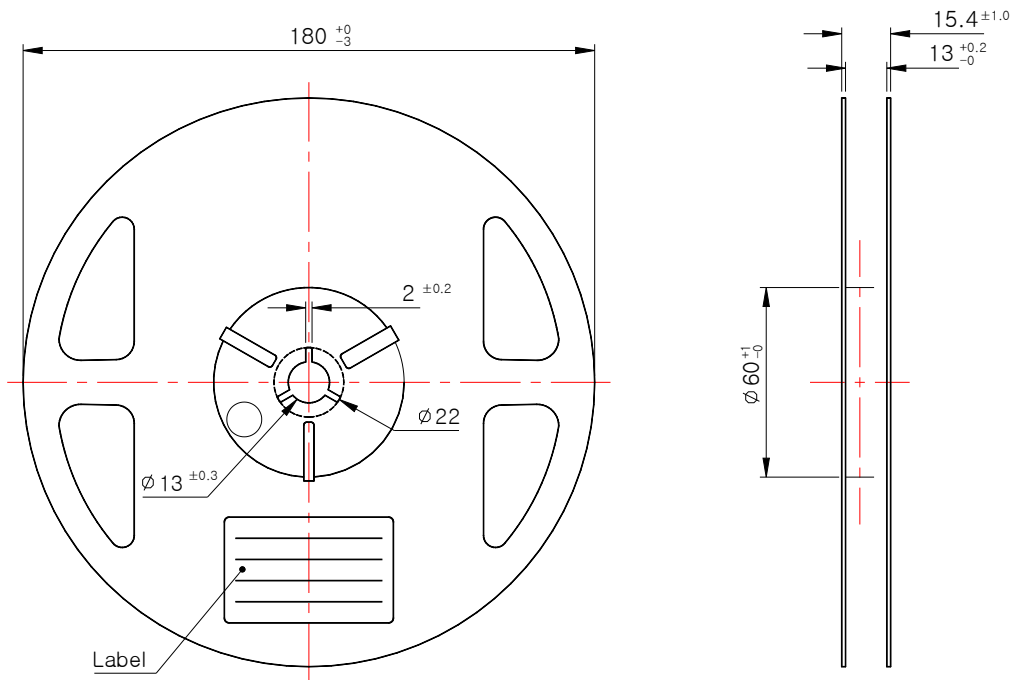
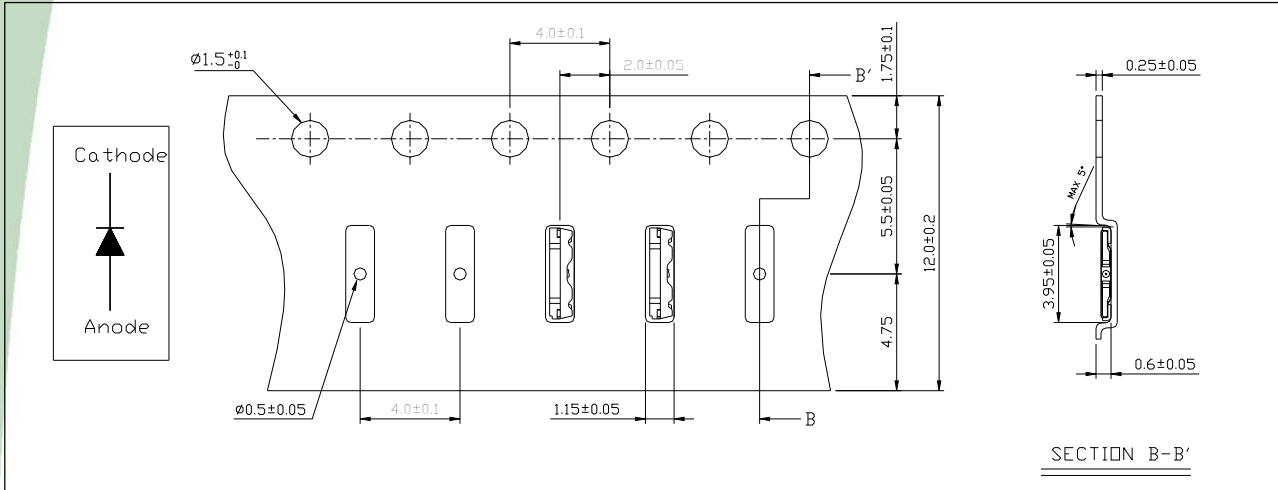

( Tolerance:  $\pm 0.2$ , Unit: mm )

- (1) Quantity : 3500pcs/Reel
- (2) Cumulative Tolerance : Cumulative Tolerance/10 pitches to be  $\pm 0.2$ mm
- (3) Adhesion Strength of Cover Tape : Adhesion strength to be 0.1-0.7N when the cover tape is turned off from the carrier tape at the angle of  $10^\circ$  to the carrier tape
- (4) Package : P/N, Manufacturing data Code No. and quantity to be indicated on a damp proof Package

Rev. 00

October, 2012

www.acrich.com

## 2) Reel Packing Structure

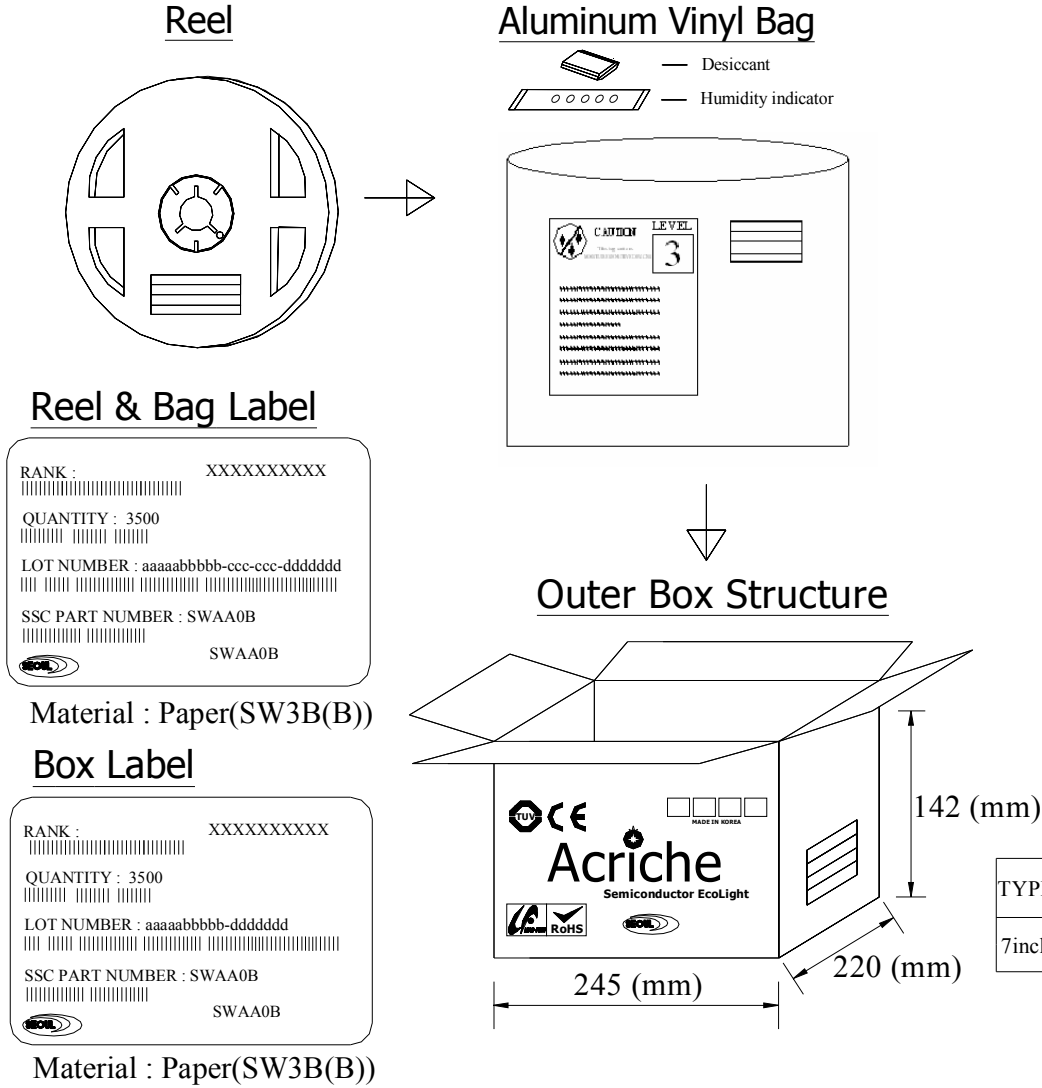

## 3) Lot Number

The lot number is composed of the following characters  
 aaaaabbbb-ccc-ccc-ddddddd

Symbol	Meaning	Example
aaaa	THE DATE	09A23 (Year : 09, A : Month, 23 : day)
bbbb	SSC's Number	Ex) S0017 0001~9999 allowance
ccc-ccc	Order of Taping	014-001
ddddddd	SSC's Number	7300024(Automatic)

Rev. 00

October, 2012

www.acrich.com

## 10. Soldering

### (1) Lead Solder

Lead Free Solder	
Pre-heat	120~150℃
Pre-heat time	120 sec. Max.
Peak-Temperature	240℃ Max.
Soldering time Condition	10 sec. Max.

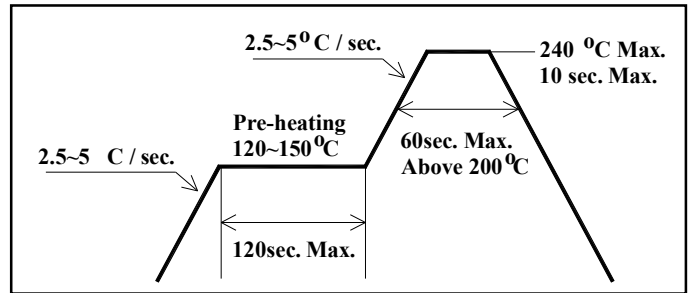

### (2) Lead-Free Solder

Lead Free Solder	
Pre-heat	150~200℃
Pre-heat time	120 sec. Max.
Peak-Temperature	260℃ Max.
Soldering time Condition	10 sec. Max.

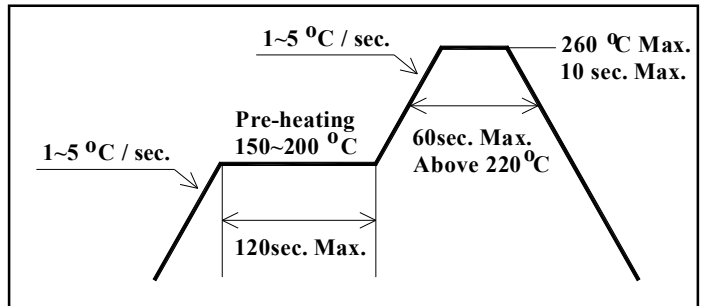

### (3) Hand Soldering conditions

Not more than 3 seconds @MAX 350°C, under Soldering iron.

Note : In case that the soldered products are reused in soldering process, we don't guarantee the products.

Rev. 00

October, 2012

www.acrich.com



## 11. Precaution for use

### (1) Storage conditions

- Keep the product in a dry box or a desiccator with a desiccant in order to prevent moisture absorption.
  - a. Keep it at a temperature in the range from 5°C to 30°C and at a humidity of less than 50% RH.
- The product should be kept within a year.

### (2) After opening the package .

- When soldering, this could result in a decrease of the photoelectric effect or light intensity.
  - a. Soldering should be done right after mounting the product.
  - b. Keep the temperature in the range from 5°C to 30°C and the humidity at less than 60%.
- Soldering should be done within 7 days after opening the desiccant package. If the product has been exposed for more than 7 days after opening the package or the indicating color of the desiccator changes, the product must be baked at a temperature between  $65 \pm 5^\circ\text{C}$  for less than 24 hours.
- An unused and unsealed product should be repacked in a desiccant package and kept sealed in a dry atmosphere.
- Stored at a humidity of less than 10% RH.

### (3) Precautions for use

- Any external mechanical force or excessive vibration should not be applied to the product during cooling after soldering, and it is preferable to avoid rapid cooling.
- The product should not be mounted on a distorted part of PCB.
- Gloves or wrist bands for ESD(Electric Static Discharge) should be wore in order to prevent ESD and surge damage, and all devices and equipments must be grounded to the earth.

### (4) Miscellaneous

- Radiation resistance is not considered.
- When cleaning the product, any kind of fluid such as water, oil and organic solvent must not be used and IPA(Isopropyl Alcohol) must be used.
- When using the product, operating current should be settled in consideration of the maximum ambient temperature.
- Its appearance or specification for improvement is subject to change without notice.