

High-Speed, Rail-to-Rail I/O, Single CMOS Operational Amplifier

■ FEATURES

- Operating Voltage: 2.7V to 5.5V
- High speed SR=9V/μs. typ(at V_{DD}= 5V)
GBW=5MHz typ
- Rail-to-Rail Input/Output
- Low input bias current I_B=1pA typ
- Unity gain stable
- Enhanced RF noise Immunity
- Package outline SOT-23-5, SC88A
- CMOS process
- Wide temperature range Ta=-40°C to 125°C

■ APPLICATIONS

- Current sensors / Sensor amplifiers
- Photodiode amplifiers
- ADC front ends
- ASIC input or output amplifiers
- Battery-powered instruments

■ PIN CONFIGURATION

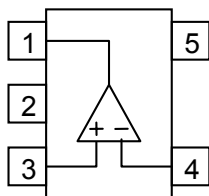

SOT-23-5, SC88A
(Top View)

PIN FUNCTION

- 1: OUTPUT
- 2: V_{SS}
- 3: +INPUT
- 4: -INPUT
- 5: V_{DD}

■ GENERAL DESCRIPTION

The NJU7046 is a single rail to rail input/output operational amplifier featuring high speed, low input bias current and wide temperature range.

High-speed characteristics of slew rate(SR=9V/us) and bandwidth (GBW=5MHz), low input bias current (I_B=1pA typ) and wide temperature range(Ta=-40°C to 125°C) makes NJU7046 especially suitable for sensors and filters application for industrial, buffers of input and output for ADC, DAC, ASIC and other wide output swing devices.

In addition to the NJU7046F3 is available in the ultra-small SC88A package. This package saves space on print circuit boards and enables the design of Battery-powered instruments.

■ PACKAGE OUTLINE



NJU7046F
(SOT-23-5)



NJU7046F3
(SC88A)

■ABSOLUTE MAXIMUM RATINGS(Ta=25°C unless otherwise noted.)

PARAMETER	SYMBOL	RATINGS	UNIT
Supply Voltage	V _{DD}	+7	V
Input Common Mode Voltage	V _{ICM}	V _{SS} -0.3 to V _{DD} +0.3	V
Differential Input Voltage	V _{ID}	±7 (Note1)	V
Power Dissipation	P _D	[SC88A] 360 (Note2), 480 (Note3)	mW
		[SOT-23-5] 480 (Note2), 640 (Note3)	
Operating Temperature Range	T _{opr}	-40 to +125	°C
Storage Temperature Range	T _{stg}	-55 to +150	°C

(Note1) For supply voltage less than +7V, the absolute maximum rating is equal to the supply voltage.

(Note2) EIA/JEDEC STANDARD Test board (76.2 x 114.3 x 1.6mm, 2layers, FR-4) mounting.

(Note3) EIA/JEDEC STANDARD Test board (76.2 x 114.3 x 1.6mm, 4layers, FR-4) mounting.

(Note4) Do not exceed "Power dissipation: P_D" in which power dissipation in IC is shown by the absolute maximum rating.

See Figure "Power Dissipation Curve" when ambient temperature is over 25° C.

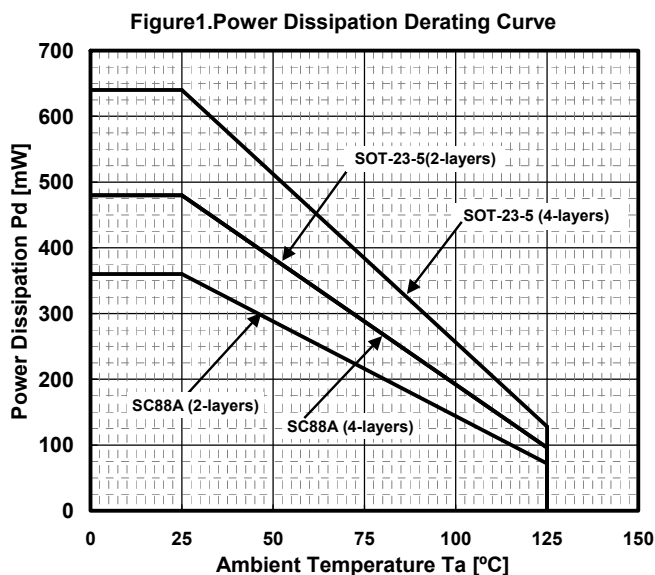

■RECOMMENDED OPERATING CONDITION (Ta=25°C)

PARAMETER	SYMBOL	RATING	UNIT
Supply Voltage	V _{DD}	2.7 to 5.5	V

■ ELECTRICAL CHARACTERISTICS

DC CHARACTER ($V_{DD}=5V$, $V_{SS}=0V$, $T_a=25^{\circ}C$, unless otherwise noted.)

PARAMETER	SYMBOL	TEST CONDITION	MIN.	TYP.	MAX.	UNIT
Supply Current	I_{CC}	No Signal	-	1.4	2.2	mA
Input Offset Voltage	V_{IO}	$V_{ICM}=5V$	-	0.9	5	mV
		$V_{ICM}=2.5V$	-	0.9	5	mV
		$V_{ICM}=0V$	-	0.9	5	mV
Input Offset Voltage Drift	$\Delta V_{IO}/\Delta T$		-	2	-	$\mu V/^{\circ}C$
Input Bias Current	I_B		-	1	-	pA
Input Offset Current	I_{IO}		-	1	-	pA
Open Loop Gain	A_V	$V_{out}=1.5V$ to $3.5V$, $R_L=10k\Omega$ to $2.5V$	90	110	-	dB
Common Mode Rejection Ratio	CMR	$V_{ICM}=0V$ to $5V$	60	80	-	dB
Supply Voltage Rejection Ratio	SVR	$V_{DD}=2.7V$ to $5.5V$, $V_{ICM}=0V$	65	90	-	dB
Maximum Output Voltage	V_{OH}	$R_L=10k\Omega$ to $2.5V$	4.95	4.99	-	V
		$R_L=600\Omega$ to $2.5V$	4.88	4.93	-	V
	V_{OL}	$R_L=10k\Omega$ to $2.5V$	-	0.01	0.05	V
		$R_L=600\Omega$ to $2.5V$	-	0.07	0.12	V
Common Mode Input Voltage Range	V_{ICM}	CMR \geq 60dB	0	-	5	V

AC CHARACTER ($V_{DD}=5V$, $V_{SS}=0V$, $V_{ICM}=2.5V$, $T_a=25^{\circ}C$, unless otherwise noted.)

PARAMETER	SYMBOL	TEST CONDITION	MIN.	TYP.	MAX.	UNIT
Gain Bandwidth Product	GBW	$G_V=40dB$, $R_F=100k\Omega$, $R_L=10k\Omega$, $C_L=20pF$	-	5	-	MHz
Phase Margin	ϕ_M	$G_V=40dB$, $R_F=100k\Omega$, $R_L=10k\Omega$, $C_L=20pF$	-	70	-	deg
Gain Margin	G_M	$G_V=40dB$, $R_F=100k\Omega$, $R_L=10k\Omega$, $C_L=20pF$	-	16	-	dB
Equivalent Input Noise Voltage	V_{NI}	$f=1kHz$	-	20	-	nV/\sqrt{Hz}
Slew Rate	SR	$G_V=0dB$, $R_L=10k\Omega$, $C_L=20pF$, $V_{IN}=2V_{PP}$	5	9	-	$V/\mu s$
Total Harmonic Distortion	THD	$G_V=0dB$, $R_L=10k\Omega$, $f=1kHz$, $V_O=1V_{rms}$	-	0.01	-	%

■ ELECTRICAL CHARACTERISTICS

DC CHARACTER ($V_{DD}=2.7V$, $V_{SS}=0V$, $T_a=25^{\circ}C$, unless otherwise noted.)

PARAMETER	SYMBOL	TEST CONDITION	MIN.	TYP.	MAX.	UNIT
Supply Current	I_{CC}	No Signal	-	1.2	2	mA
Input Offset Voltage	V_{IO}	$V_{ICM}=2.7V$	-	0.9	5	mV
		$V_{ICM}=1.35V$	-	0.9	5	mV
		$V_{ICM}=0V$	-	0.9	5	mV
Input Offset Voltage Drift	$\Delta V_{IO}/\Delta T$		-	2	-	$\mu V/^{\circ}C$
Input Bias Current	I_B		-	1	-	pA
Input Offset Current	I_{IO}		-	1	-	pA
Open Loop Gain	A_V	$V_{out}=0.35V$ to $2.35V$, $R_L=10k\Omega$ to $1.35V$	90	110	-	dB
Common Mode Rejection Ratio	CMR	$V_{ICM}=0V$ to $2.7V$	55	75	-	dB
Maximum Output Voltage	V_{OH}	$R_L=10k\Omega$ to $1.35V$	2.65	2.69	-	V
		$R_L=600\Omega$ to $1.35V$	2.6	2.64	-	V
	V_{OL}	$R_L=10k\Omega$ to $1.35V$	-	0.01	0.05	V
		$R_L=600\Omega$ to $1.35V$	-	0.05	0.1	V
Common Mode Input Voltage Range	V_{ICM}	CMR \geq 55dB	0	-	2.7	V

AC CHARACTER ($V_{DD}=5V$, $V_{SS}=0V$, $V_{ICM}=2.5V$, $T_a=25^{\circ}C$, unless otherwise noted.)

PARAMETER	SYMBOL	TEST CONDITION	MIN.	TYP.	MAX.	UNIT
Gain Bandwidth Product	GBW	$G_V=40dB$, $R_F=100k\Omega$, $R_L=10k\Omega$, $C_L=20pF$	-	5	-	MHz
Phase Margin	ϕ_M	$G_V=40dB$, $R_F=100k\Omega$, $R_L=10k\Omega$, $C_L=20pF$	-	65	-	deg
Gain Margin	G_M	$G_V=40dB$, $R_F=100k\Omega$, $R_L=10k\Omega$, $C_L=20pF$	-	18	-	dB
Equivalent Input Noise Voltage	V_{NI}	$f=1kHz$	-	20	-	nV/\sqrt{Hz}
Slew Rate	SR	$G_V=0dB$, $R_L=10k\Omega$, $C_L=20pF$, $V_{IN}=2V_{PP}$	3.5	7	-	$V/\mu s$
Total Harmonic Distortion	THD	$G_V=0dB$, $R_L=10k\Omega$, $f=1kHz$, $V_O=1V_{rms}$	-	0.02	-	%

■ TYPICAL CHARACTERISTICS

Gain/Phase vs. Frequency (Temperature)
 $G_V=40\text{dB}$, $V_{DD}=5\text{V}$, $R_F=100\text{k}\Omega$, $R_G=1\text{k}\Omega$, $R_L=10\text{k}\Omega$, $C_L=20\text{pF}$

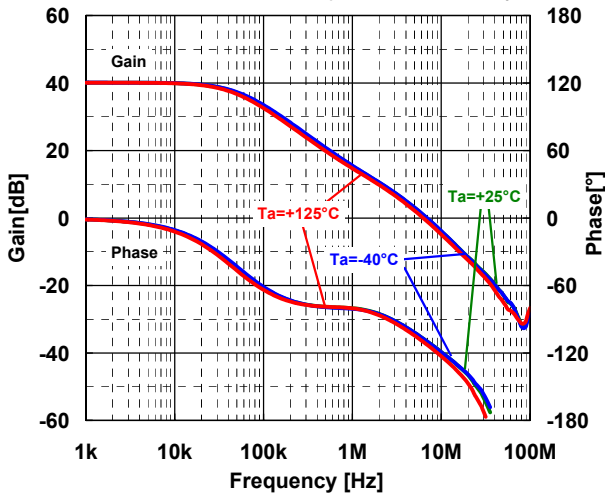

Gain/Phase vs. Frequency (Temperature)
 $G_V=40\text{dB}$, $V_{DD}=2.7\text{V}$, $R_F=100\text{k}\Omega$, $R_G=1\text{k}\Omega$, $R_L=10\text{k}\Omega$, $C_L=20\text{pF}$

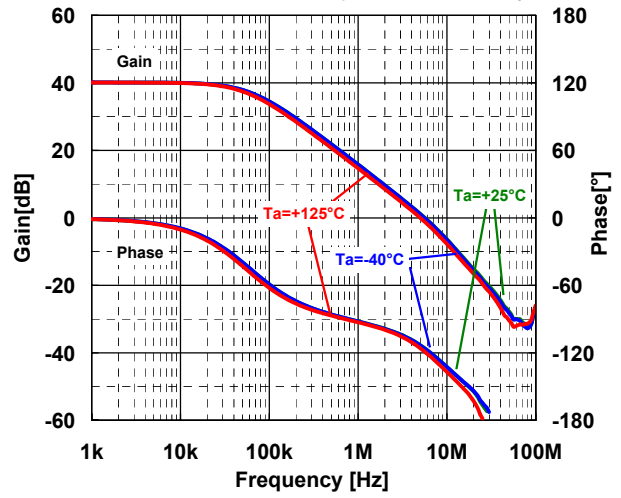

Gain/Phase vs. Frequency (Load Capacitance)
 $G_V=40\text{dB}$, $V_{DD}=5\text{V}$, $R_F=100\text{k}\Omega$, $R_G=1\text{k}\Omega$, $R_L=10\text{k}\Omega$, $T_a=25^\circ\text{C}$

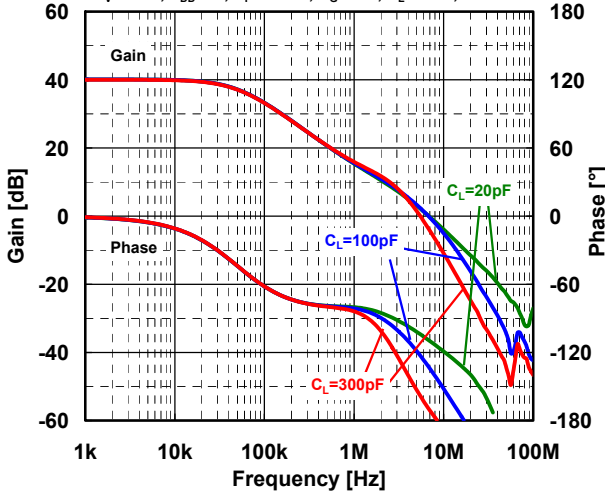

Gain/Phase vs. Frequency (Load Capacitance)
 $G_V=40\text{dB}$, $V_{DD}=2.7\text{V}$, $R_F=100\text{k}\Omega$, $R_G=1\text{k}\Omega$, $R_L=10\text{k}\Omega$, $T_a=25^\circ\text{C}$

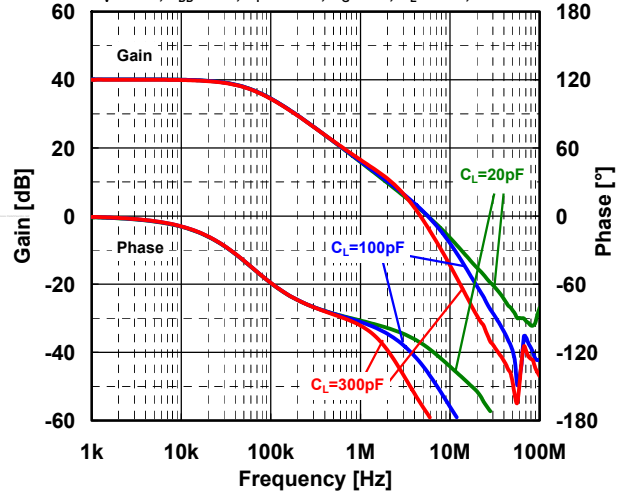

Unity Gain Frequency Response (Load Capacitance)
 $G_V=0\text{dB}$, $V_{DD}=5\text{V}$, $T_a=25^\circ\text{C}$

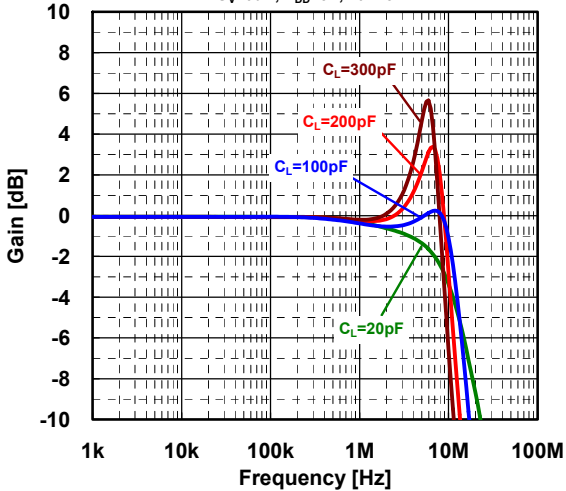

Unity Gain Frequency Response (Load Capacitance)
 $G_V=0\text{dB}$, $V_{DD}=2.7\text{V}$, $T_a=25^\circ\text{C}$

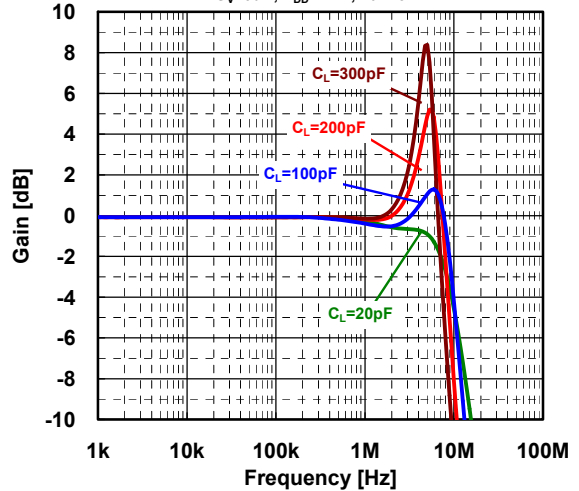

Transient Response (Temperature)
 $V_{DD}=5V, V_{IN}=2V_{pp}, R_L=10k\Omega, C_L=20pF$

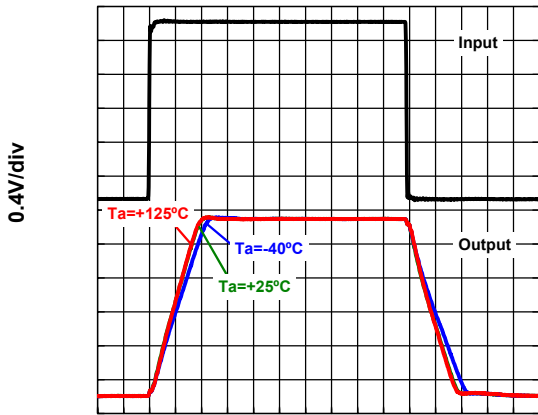

0.1µs/div

Transient Response (Temperature)
 $V_{DD}=2.7V, V_{IN}=2V_{pp}, R_L=10k\Omega, C_L=20pF$

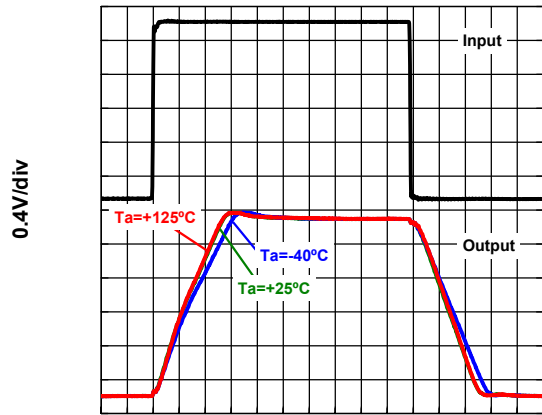

0.1µs/div

Transient Response (Load Capacitance)
 $V_{DD}=5V, V_{IN}=2V_{pp}, R_L=10k\Omega, Ta=25^\circ C$

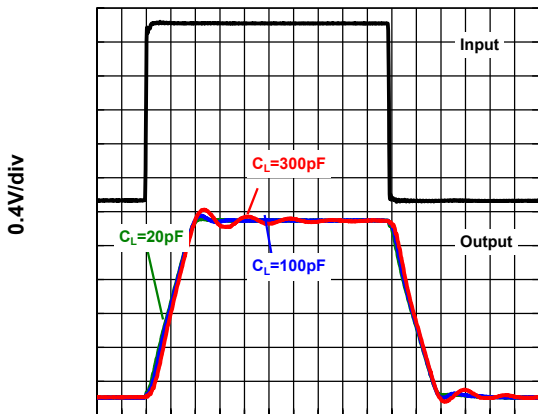

0.1µs/div

Transient Response (Load Capacitance)
 $V_{DD}=2.7V, V_{IN}=2V_{pp}, R_L=10k\Omega, Ta=25^\circ C$

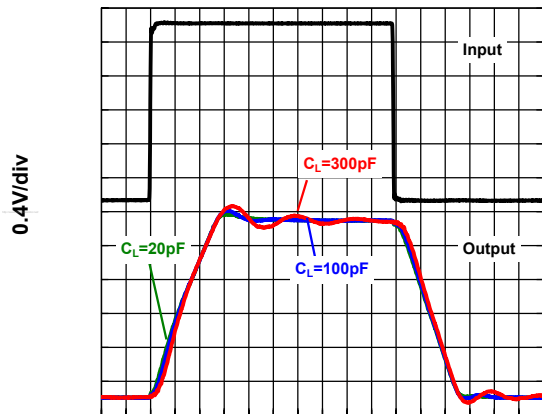

0.1µs/div

Gain Bandwidth Product vs. Temperature
 $G_V=40dB, R_L=10k\Omega, C_L=20pF$

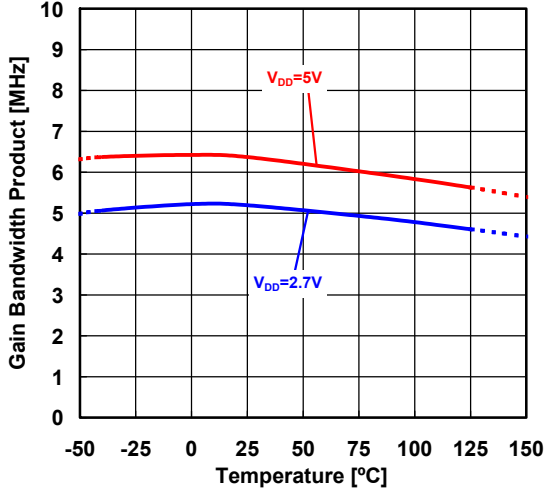

Slew Rate vs. Temperature (Supply Voltage)
 $G_V=0dB, V_{IN}=1V_{pp}, R_L=10k\Omega, C_L=20pF$

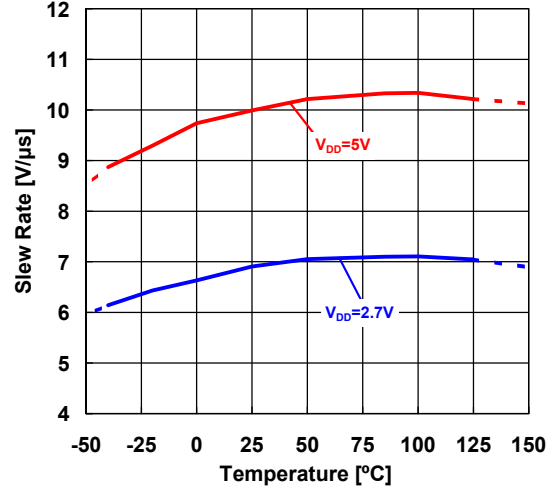

Input Offset Voltage Distribution

$V_{DD}=5V, V_{ICM}=2.5V, T_a=25^\circ C$

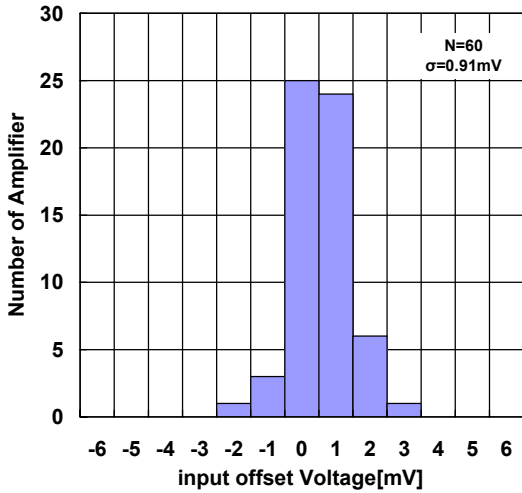

Input Offset Voltage Drift Distribution

$V_{DD}=5V, V_{ICM}=2.5V, T_a=-40^\circ C$ to $125^\circ C$

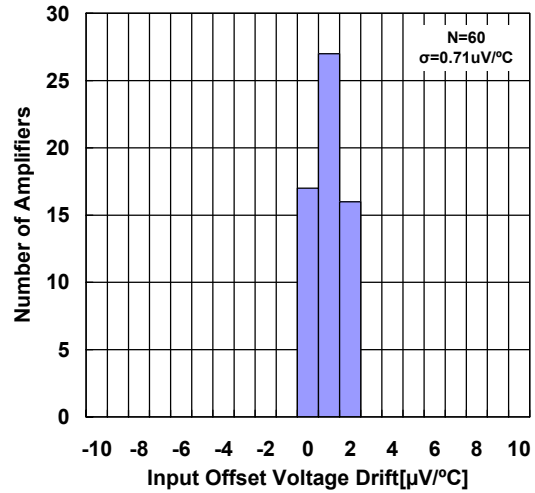

Input Offset Voltage vs. Temperature

$V_{DD}=5V, V_{ICM}=2.5V$

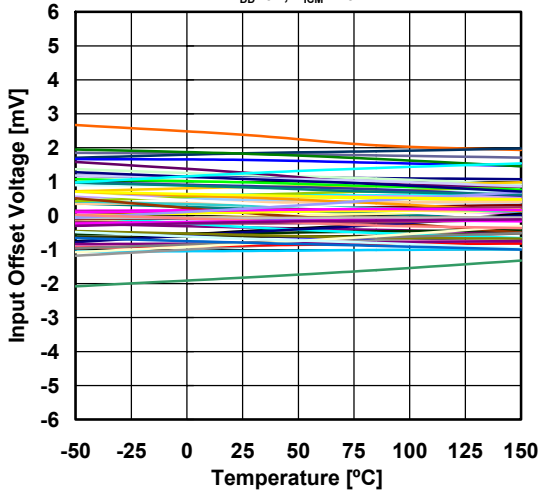

Supply Current vs. Temperature

$V_{ICM}=V_{DD}/2$

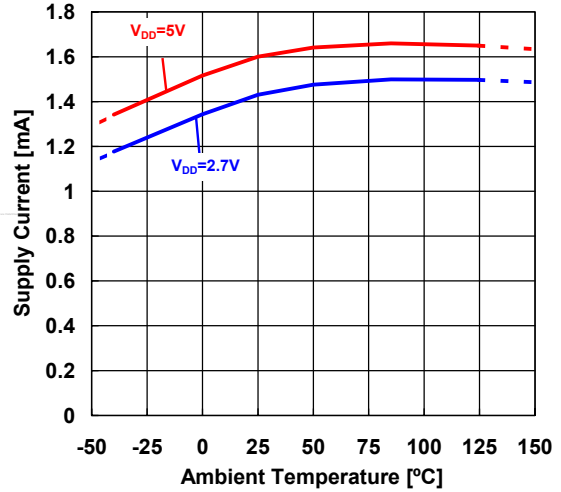

Supply Current vs. Supply Voltage (Temperature)

$V_{ICM}=V_{DD}/2$

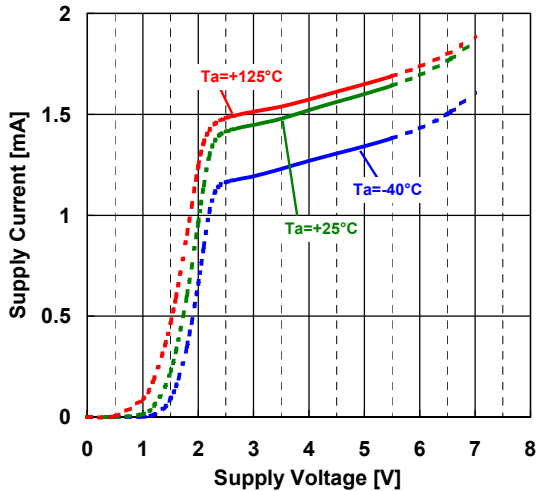

Input Voltage Noise vs. Frequency

$V_{DD}=5V, R_S=100\Omega, R_F=10k\Omega, T_a=25^\circ C$

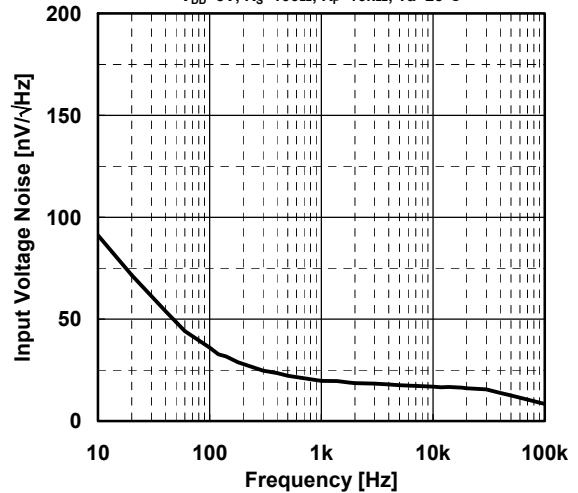

Input Offset Voltage vs. Common Mode Input Voltage (Temperature)
 $V_{DD}=5V, V_{ICM}=V_{DD}/2$

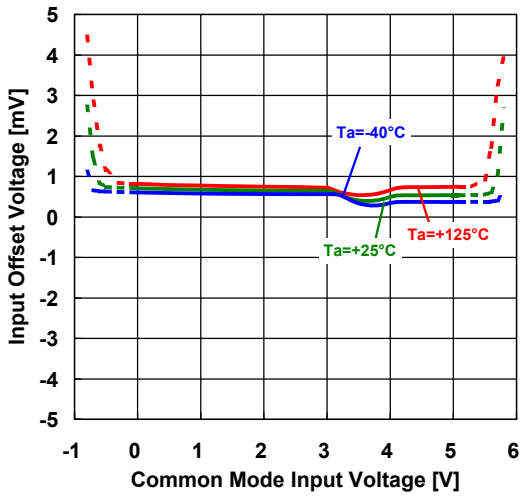

Input Offset Voltage vs. Common Mode Input Voltage (Temperature)
 $V_{DD}=2.7V, V_{ICM}=V_{DD}/2$

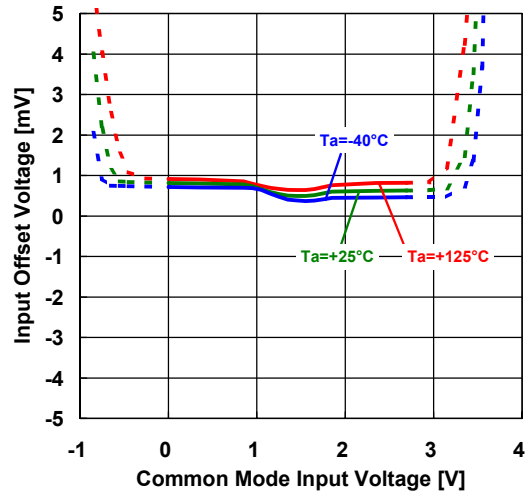

CMR vs. Temperature (Supply Voltage)
 $V_{ICM}=V_{SS} \text{ to } V_{DD}$

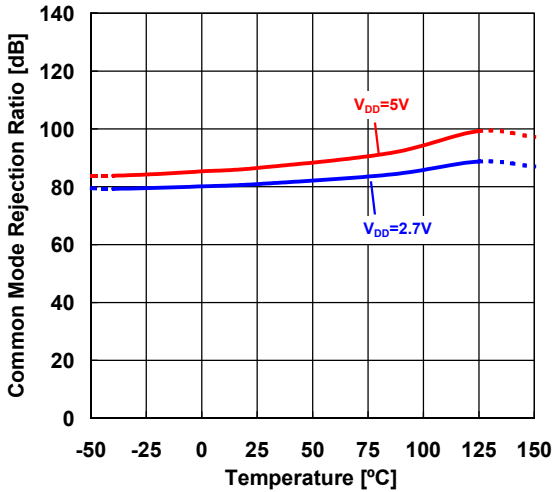

Open Loop Gain vs. Temperature (Supply Voltage)
 $V_O=V_{DD}/2 \pm 1V$

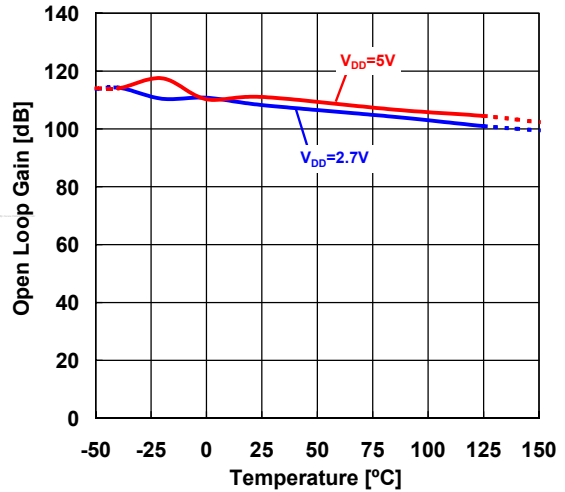

SVR vs. Temperature
 $V_{DD}=2.7V \text{ to } 5.5V$

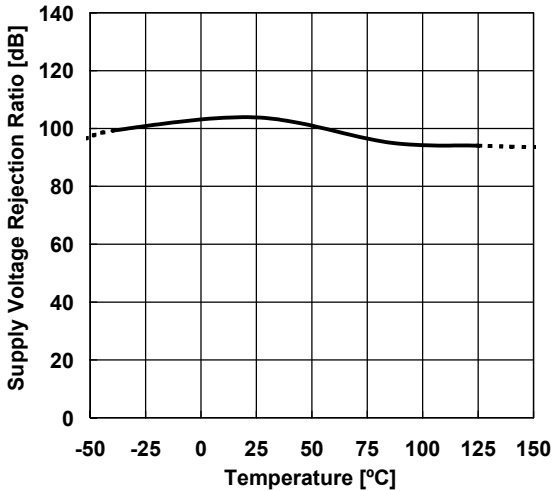

Maximum Output Voltage vs. Load Resistance
 $T_a=25^\circ C$

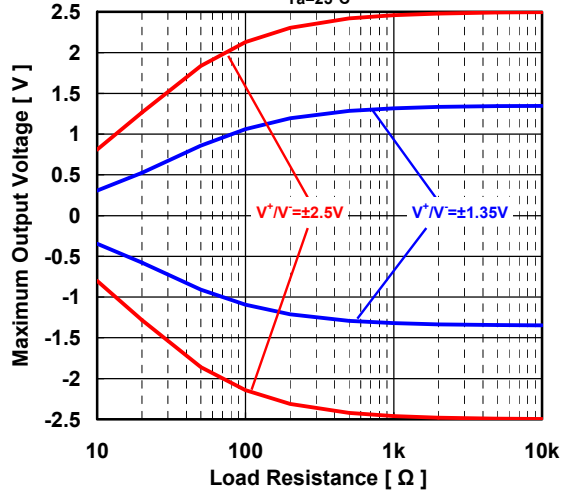

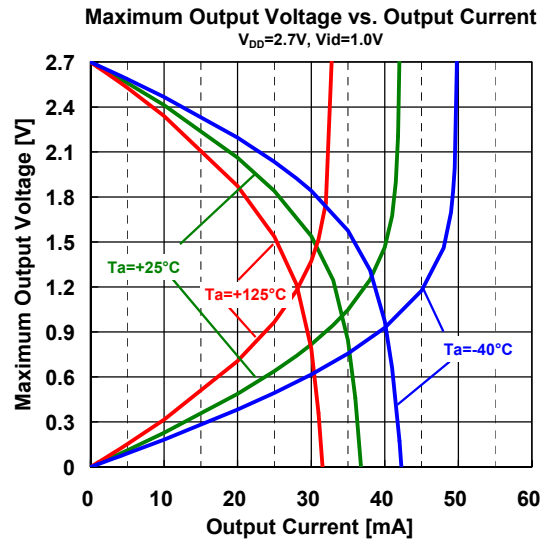
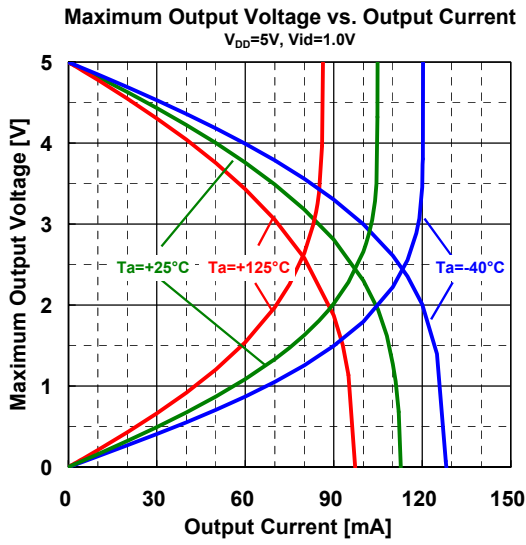

NJU7046

■ PACKAGE DIMENSIONS

SOT-23-5

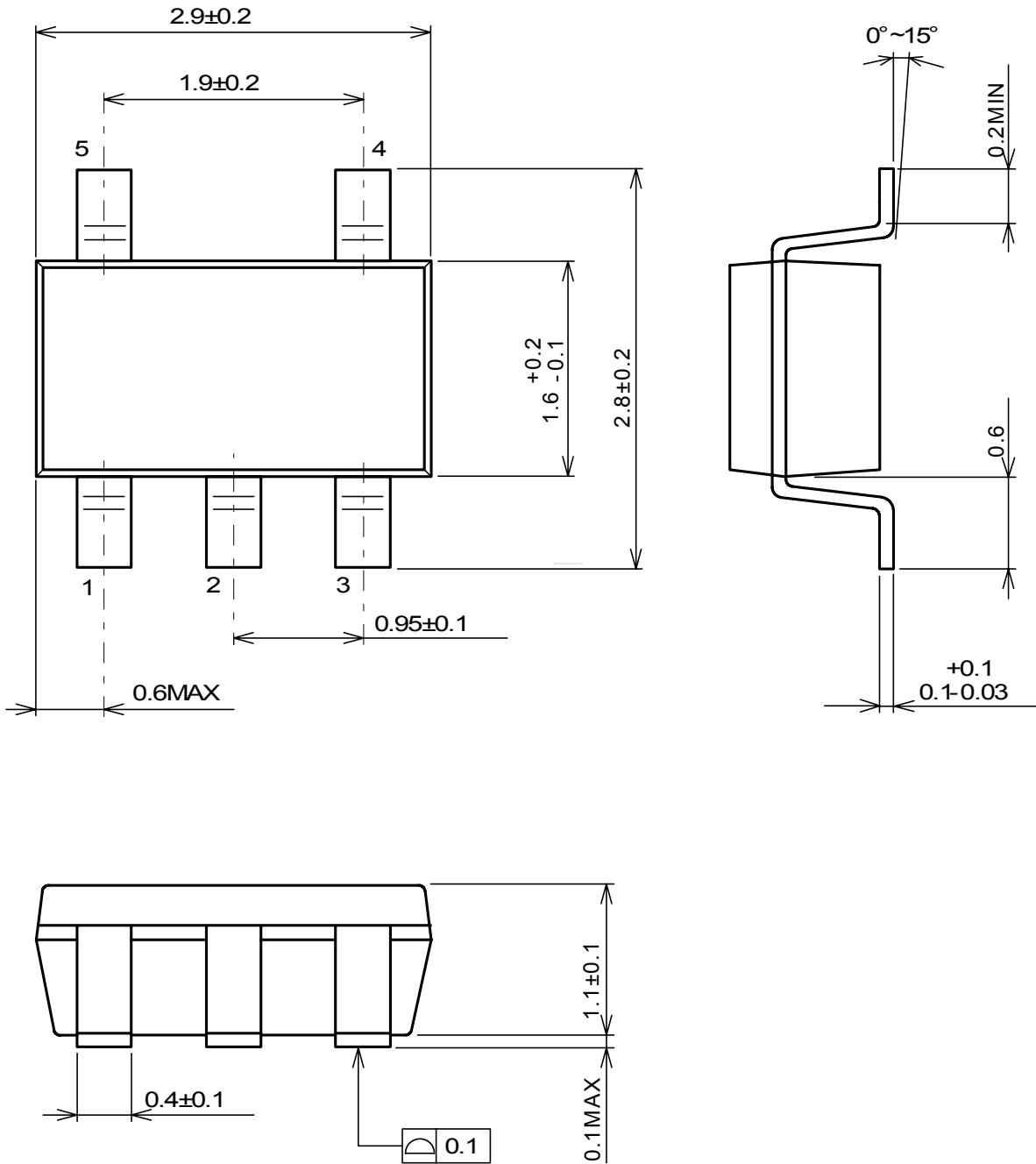

UNIT: mm

■ PACKAGE DIMENSIONS

SC88A

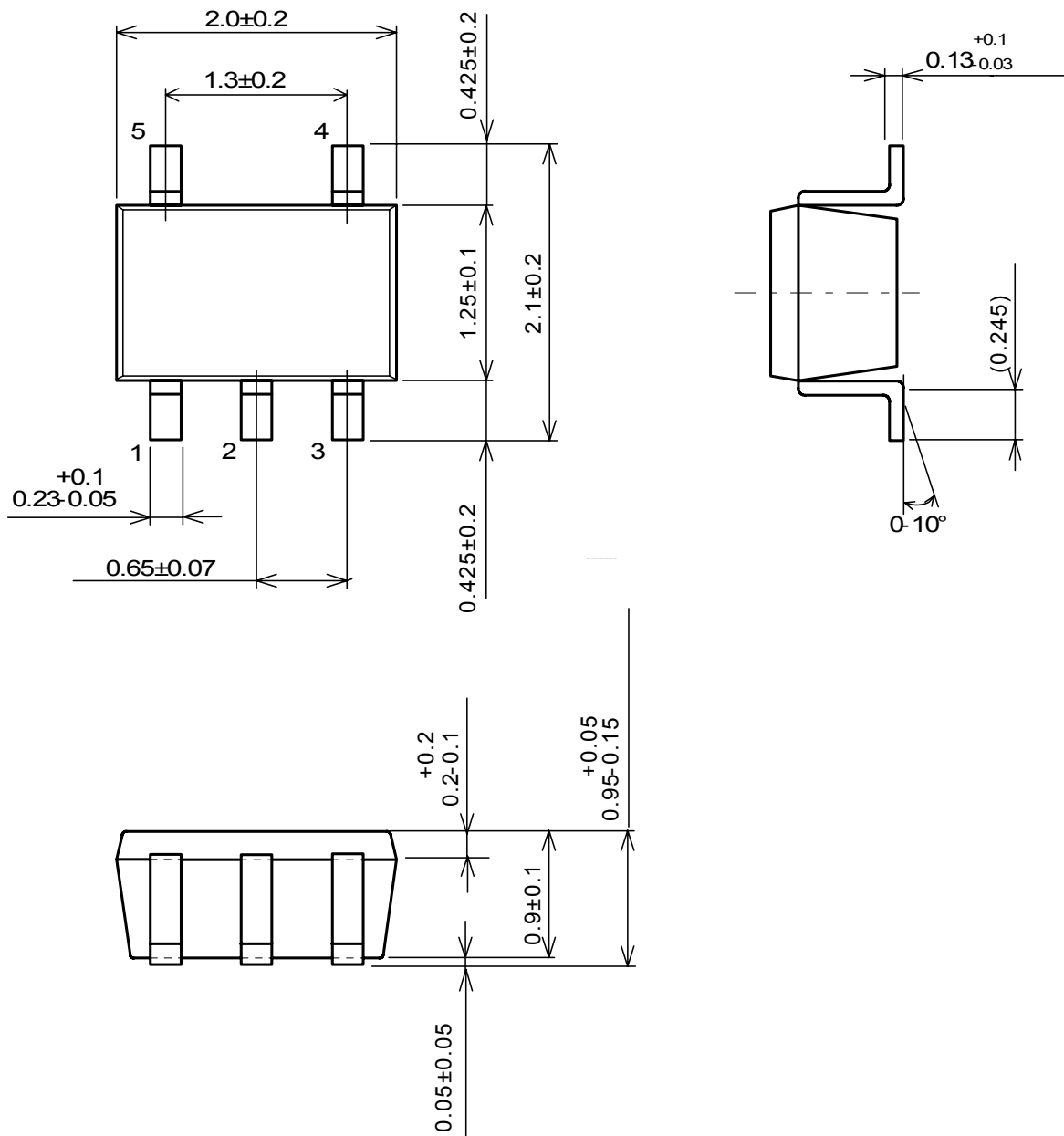

UNIT: mm

■ MEMO

[CAUTION]

The specifications on this databook are only given for information, without any guarantee as regards either mistakes or omissions. The application circuits in this databook are described only to show representative usages of the product and not intended for the guarantee or permission of any right including the industrial rights.