

## 1.2A Integrated FETs, High Efficiency Synchronous Buck Regulator

ISL8011 is an integrated FET, 1.2A synchronous buck regulator for general purpose point-of load applications. It is optimized for generating low output voltages down to 0.8V. The supply voltage range is from 2.7V to 5.5V allowing the use from common 3.3V or 5V supply rails and Lithium ion battery inputs. It has guaranteed minimum output current of 1.2A. 1.5MHz pulse-width modulation (PWM) switching frequency allowing the use of small external components.

The ISL8011 includes a pair of low ON-resistance P-Channel and N-Channel internal MOSFETs to maximize efficiency and minimize external component count. 100% duty-cycle operation allows less than 200mV dropout voltage at 1.2A.

The ISL8011 offers a 200ms Power-On-Reset (POR) timer at power-up. When shutdown, the ISL8011 discharges the output capacitor. Other features include internal digital soft-start, enable for power sequence, overcurrent protection, and thermal shutdown.

The ISL8011 is offered in a 10 Ld 3mmx3mm DFN package with 1mm maximum height. The complete converter occupies less than 1cm<sup>2</sup> area.

### Ordering Information

PART NUMBER (Note)	PART MARKING	TEMP. RANGE (°C)	PACKAGE (Pb-Free)	PKG. DWG. #
ISL8011IRZ	011Z	-40 to +85	10 Ld 3x3 DFN	L10.3x3C
ISL8011IRZ-T*	011Z	-40 to +85	10 Ld 3x3 DFN Tape and Reel	L10.3x3C

\*Please refer to TB347 for details on reel specifications.

NOTE: These Intersil Pb-free plastic packaged products employ special Pb-free material sets, molding compounds/die attach materials, and 100% matte tin plate plus anneal (e3 termination finish, which is RoHS compliant and compatible with both SnPb and Pb-free soldering operations). Intersil Pb-free products are MSL classified at Pb-free peak reflow temperatures that meet or exceed the Pb-free requirements of IPC/JEDEC J STD-020.

### Features

- High Efficiency Synchronous Buck Regulator with Up to 95% Efficiency
- 2.7V to 5.5V Supply Voltage
- 1.2A Output Current
- 100% Maximum Duty Cycle
- Peak Current Limiting, Short Circuit Protection
- 200ms Power-On Reset
- 3% Output Accuracy Over-Temperature/Load/Line
- Less than 1µA Logic Controlled Shutdown Current
- Internal Loop Compensation
- Internal Digital Soft-Start
- Over-Temperature Protection
- Enable
- Small 10 Ld 3mmx3mm DFN
- Pb-Free (RoHS Compliant)

### Applications

- DC/DC POL Modules
- µC/µP, FPGA and DSP Power
- Plug-in DC/DC Modules for Routers and Switchers
- Portable Instruments
- Test and Measurement Systems

### Pinout

**ISL8011**  
**(10 LD 3x3 DFN)**  
TOP VIEW

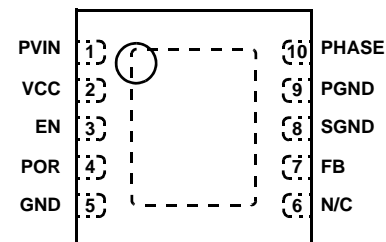

**Absolute Maximum Ratings** (Reference to SGND)

Supply Voltage (PVIN, V <sub>CC</sub> )	-0.3V to 6.5V
EN, MODE, PHASE, POR	-0.3V to V <sub>CC</sub> +0.3V
FB	-0.3V to 2.7V
PGND	-0.3V to 0.3V

**Recommended Operating Conditions**

PVIN Supply Voltage Range	2.7V to 5.5V
Load Current Range	0A to 1.2A
Ambient Temperature Range	-40°C to +85°C

**Thermal Information**

Thermal Resistance (Notes 1, 2)	$\theta_{JA}$ (°C/W)	$\theta_{JC}$ (°C/W)
10 Ld 3x3 DFN Package	48	5
Junction Temperature Range	-55°C to +125°C	
Storage Temperature Range	-65°C to +150°C	
Pb-free reflow profile	see link below	
<a href="http://www.intersil.com/pbfree/Pb-FreeReflow.asp">http://www.intersil.com/pbfree/Pb-FreeReflow.asp</a>		

*AUTION: Do not operate at or near the maximum ratings listed for extended periods of time. Exposure to such conditions may adversely impact product reliability and result in failures not covered by warranty.*

**NOTES:**

1.  $\theta_{JA}$  is measured in free air with the component mounted on a high effective thermal conductivity test board with “direct attach” features. See Tech Brief TB379.
2.  $\theta_{JC}$ , “case temperature” location is at the center of the exposed metal pad on the package underside. See Tech Brief TB379.

**Electrical Specifications**  $T_A = +25^\circ\text{C}$ ,  $V_{PVIN} = V_{VCC} = 3.6\text{V}$ ,  $EN = V_{CC}$ ,  $L = 1.8\mu\text{H}$ ,  $C_1 = 10\mu\text{F}$ ,  $C_2 = 10\mu\text{F}$ ,  $I_{OUT} = 0\text{A}$  (see “Typical Applications” on page 6); Parameters with MIN and/or MAX limits are 100% tested at +25°C, unless otherwise specified. Temperature limits established by characterization and are not production tested.

PARAMETER	SYMBOL	TEST CONDITIONS	MIN	TYP	MAX	UNITS
<b>SUPPLY</b>						
V <sub>CC</sub> Undervoltage Lockout Threshold	V <sub>UVLO</sub>	Rising	-	2.5	2.7	V
		Falling	2.2	2.4	-	V
Quiescent Supply Current	I <sub>PVIN</sub>	No load at the output	-	5	8	mA
Shut Down Supply Current	I <sub>SD</sub>	V <sub>CC</sub> = PVIN = 5.5V, EN = low	-	0.1	2	μA
<b>OUTPUT REGULATION</b>						
FB Regulation Voltage	V <sub>FB</sub>	T <sub>A</sub> = 0°C to +85°C	0.784	0.8	0.816	V
		T <sub>A</sub> = -40°C to +85°C	0.78	0.8	0.82	V
FB Bias Current	I <sub>FB</sub>	FB = 0.75V	-	0.1	-	μA
Output Voltage Accuracy		PVIN = V <sub>O</sub> + 0.5V to 5.5V, I <sub>O</sub> = 0A to 1.2A, T <sub>A</sub> = -40°C to +85°C	-3	-	3	%
Line Regulation		PVIN = V <sub>O</sub> + 0.5V to 5.5V (minimal 2.7V)	-	0.2	-	%/V
Maximum Output Current			1.2	-	-	A
<b>COMPENSATION</b>						
Error Amplifier Trans-conductance		Adjustable version, design info only	-	20	-	μA/V
<b>PHASE</b>						
P-Channel MOSFET On-Resistance		PVIN = 3.6V, I <sub>O</sub> = 200mA	-	0.12	0.22	Ω
		PVIN = 2.7V, I <sub>O</sub> = 200mA	-	0.16	0.27	Ω
N-Channel MOSFET On-Resistance		PVIN = 3.6V, I <sub>O</sub> = 200mA	-	0.11	0.22	Ω
		PVIN = 2.7V, I <sub>O</sub> = 200mA	-	0.15	0.27	Ω
P-Channel MOSFET Peak Current Limit	I <sub>PK</sub>		1.5	2.1	2.6	A
PHASE Maximum Duty Cycle			-	100	-	%
PWM Switching Frequency	f <sub>S</sub>	T <sub>A</sub> = -40°C to +85°C	1.35	1.6	1.75	MHz
PHASE Minimum On Time			-	-	140	ns
Soft Start-Up Time			-	1.1	-	ms

**Electrical Specifications**  $T_A = +25^\circ\text{C}$ ,  $V_{PVIN} = V_{VCC} = 3.6\text{V}$ ,  $EN = V_{CC}$ ,  $L = 1.8\mu\text{H}$ ,  $C_1 = 10\mu\text{F}$ ,  $C_2 = 10\mu\text{F}$ ,  $I_{OUT} = 0\text{A}$  (see "Typical Applications" on page 6); Parameters with MIN and/or MAX limits are 100% tested at  $+25^\circ\text{C}$ , unless otherwise specified. Temperature limits established by characterization and are not production tested. **(Continued)**

PARAMETER	SYMBOL	TEST CONDITIONS	MIN	TYP	MAX	UNITS
<b>POR</b>						
Output Low Voltage		Sinking 1mA, FB = 0.7V	-	-	0.3	V
Delay Time			150	200	275	ms
POR Pin Leakage Current		POR = $V_{CC} = 3.6\text{V}$	-	0.01	0.1	$\mu\text{A}$
Minimum Supply Voltage for Valid POR Signal			1.2	-	-	V
Internal PGOOD Low Rising Threshold		Percentage of Nominal Regulation Voltage	89.5	92	94.5	%
Internal PGOOD Low Falling Threshold		Percentage of Nominal Regulation Voltage	85	88	91	%
Internal PGOOD High Rising Threshold		Percentage of Nominal Regulation Voltage	105.5	108	110.5	%
Internal PGOOD High Falling Threshold		Percentage of Nominal Regulation Voltage	102	105	108	%
Internal PGOOD Delay Time			-	50	-	$\mu\text{s}$
<b>EN</b>						
Logic Input Low			-	-	0.4	V
Logic Input High			1.4	-	-	V
Logic Input Leakage Current		Pulled up to 5.5V	-	0.1	1	$\mu\text{A}$
Thermal Shutdown			-	150	-	$^\circ\text{C}$
Thermal Shutdown Hysteresis			-	25	-	$^\circ\text{C}$

**Typical Operating Performance**

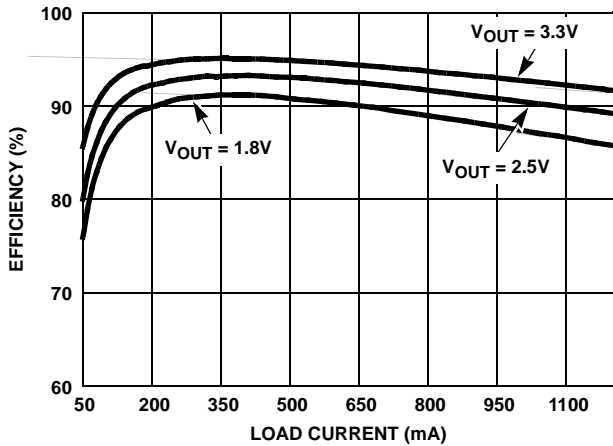

FIGURE 1. EFFICIENCY vs LOAD CURRENT ( $V_{IN} = 5.0\text{V}$ )

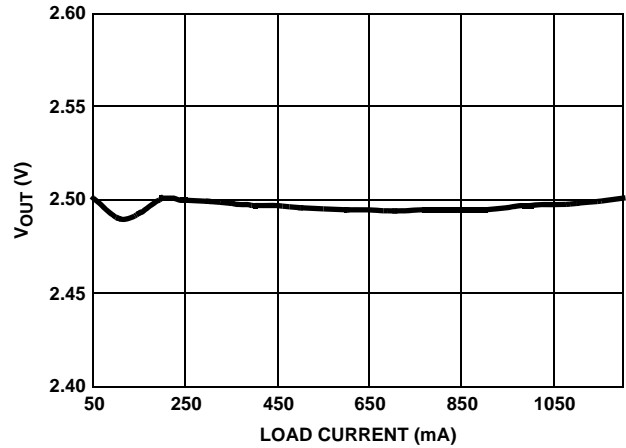

FIGURE 2.  $V_{OUT}$  vs LOAD CURRENT ( $V_{IN} = 5\text{V}$ )

Typical Operating Performance (Continued)

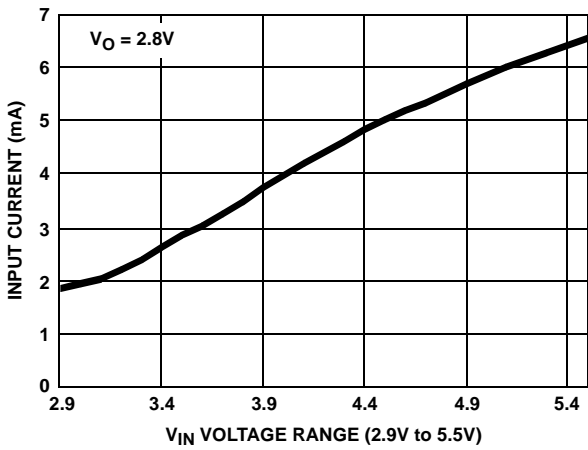

FIGURE 3.  $I_Q$  vs  $V_{IN}$

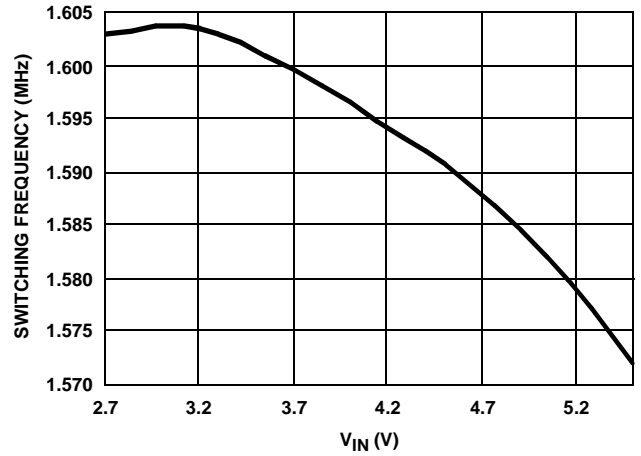

FIGURE 4. SWITCHING FREQUENCY vs  $V_{IN}$

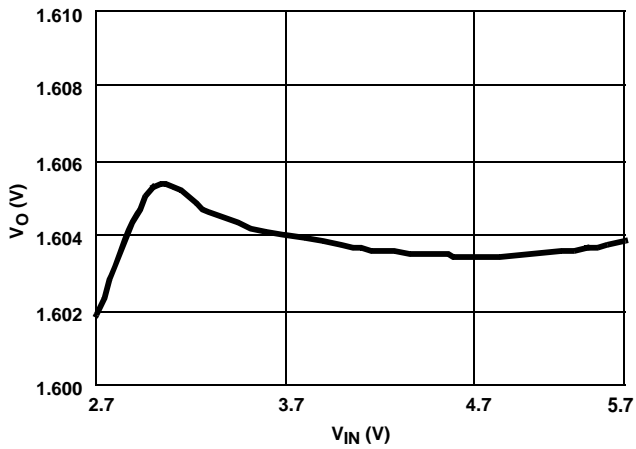

FIGURE 5. LINE REGULATION ( $I_O = 1A$ )

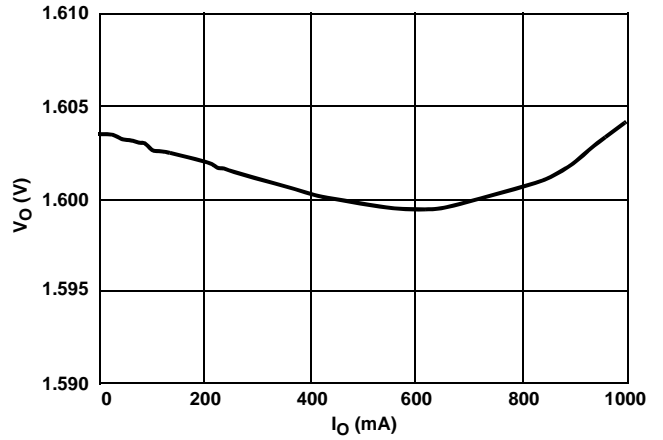

FIGURE 6. LOAD REGULATION ( $V_{IN} = 3.6V$ )

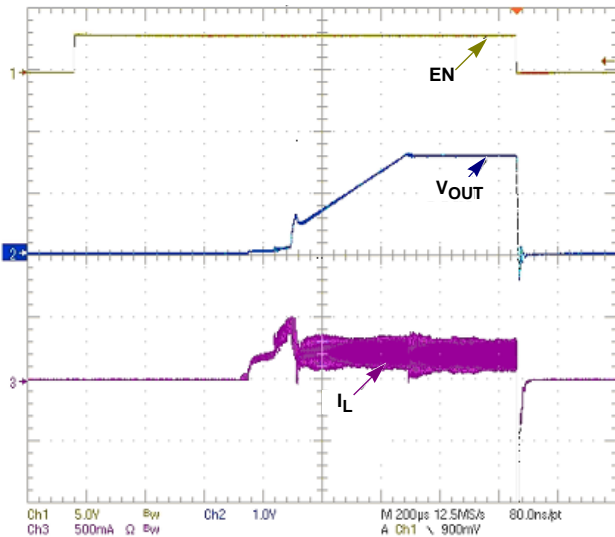

FIGURE 7. SOFT-START

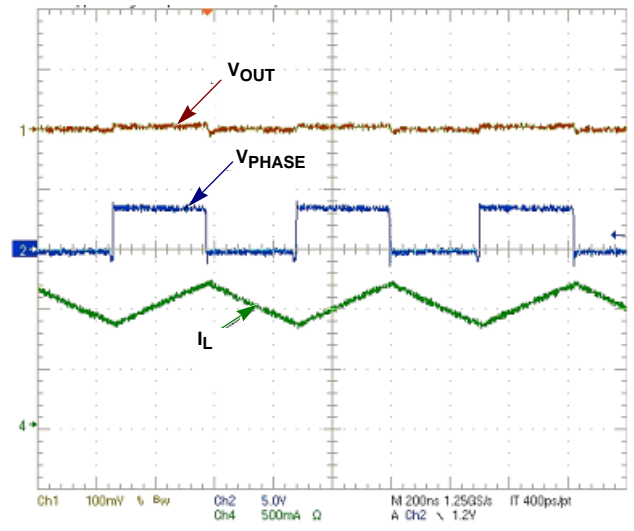

FIGURE 8. STEADY-STATE ( $V_{IN} = 3.6V$ ;  $V_O = 1.6V$ ;  $I_O = 1A$ )

**Typical Operating Performance** (Continued)

FIGURE 9. LOAD TRANSIENT ( $V_{IN} = 3.6V$ ;  $V_O = 1.6V$ ;  $I_O = 0A$  TO  $\sim 1A$ )

**Pin Descriptions****PVIN**

Input supply voltage. Connect a  $10\mu F$  ceramic capacitor to power ground.

**VCC**

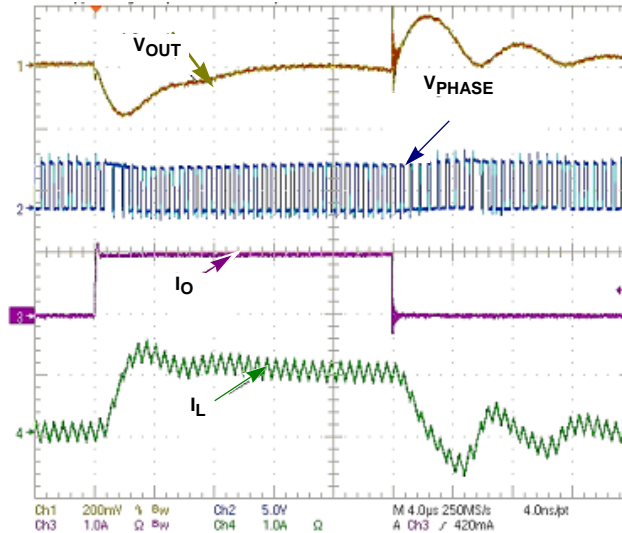
Supply voltage for internal analog and digital control circuits, delivered from PVIN. Bypass with  $0.1\mu F$  ceramic capacitor to signal ground.

**EN**

Regulator enable pin. Force this pin above  $1.4V$  enable the chip. Force this pin below  $0.4V$  shutdown the chip and discharge output capacitor when driven to low. Do not leave this pin floating.

**POR**

200ms timer output. At power-up or EN HI, this output is a 200ms delayed Power-Good signal for the output voltage.

**GND**

Ground. **Connect this pin to the exposed pad and SGND.**

**PHASE**

Switching node connection. Connect to one terminal of inductor.

**PGND**

Power ground. Connect all power grounds to this pin.

**SGND**

Analog ground. SGND and PGND should only have one point connection.

**FB**

Buck regulator output feedback. Connect to the output through a resistor divider for adjustable the output voltage.

**Exposed Pad**

The exposed pad must be connected to the PGND pin for proper electrical performance and optimal thermal performance.

**NC**

**NC is the No Connect pin. Tie this pin to SGND to prevent noise.**

Typical Applications

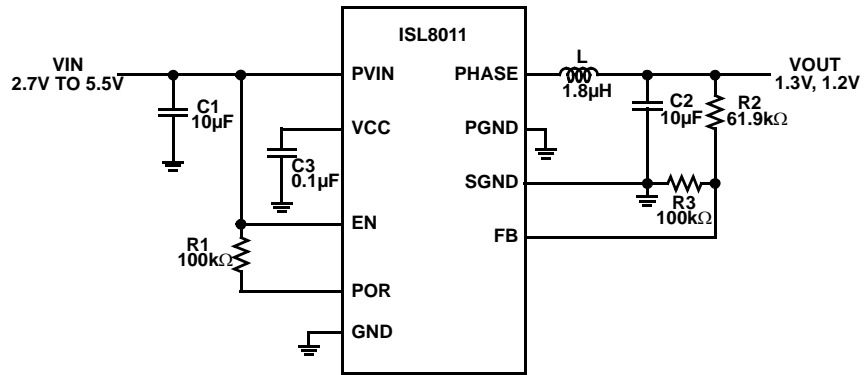

FIGURE 10. TYPICAL APPLICATION FOR ADJUSTABLE VERSION

Block Diagram

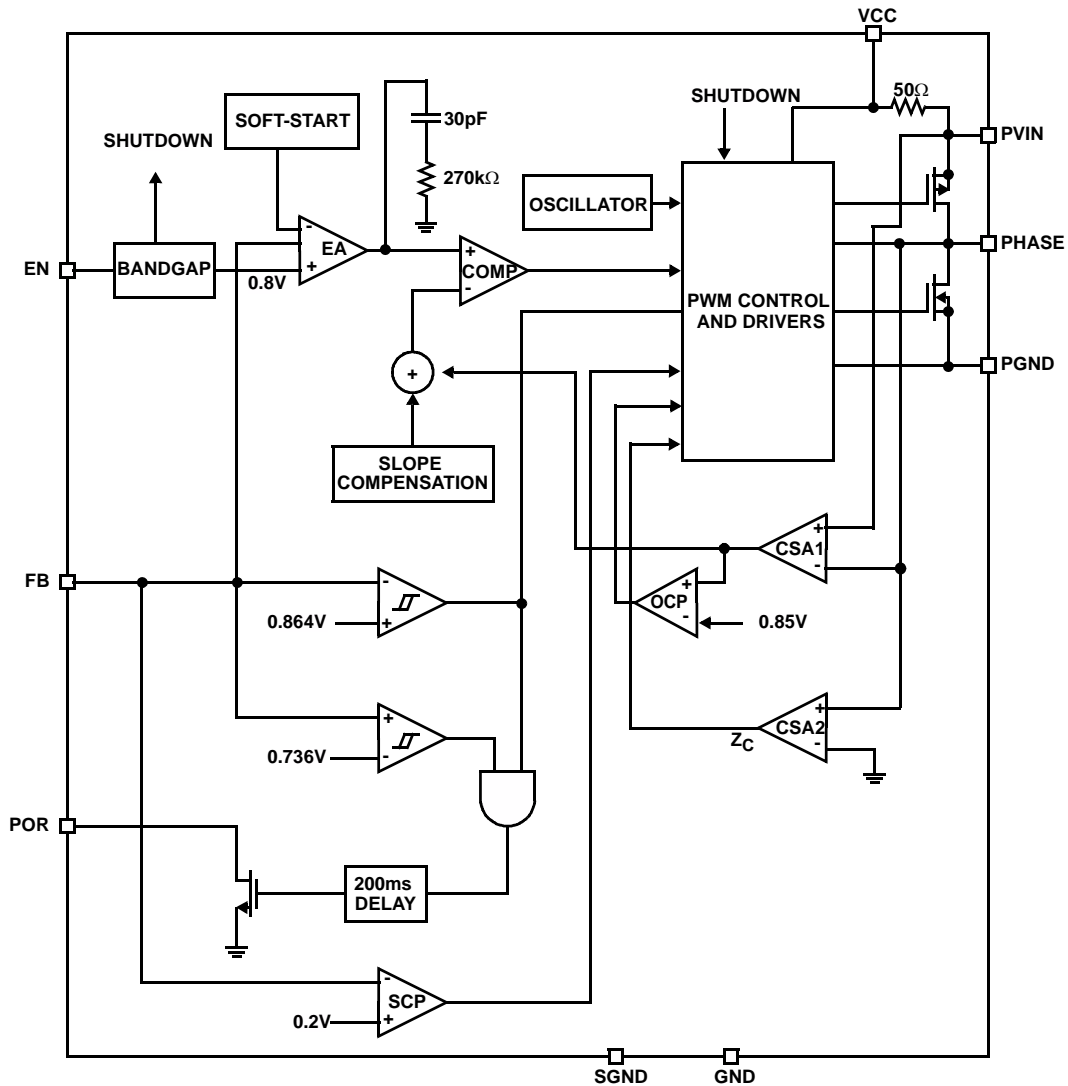

FIGURE 11. FUNCTIONAL BLOCK DIAGRAM

## Theory of Operation

ISL8011 is an integrated FET, 1.2A synchronous buck regulator for general purpose point-of load applications. The regulator operates at 1.5MHz fixed switching frequency under heavy load condition to allow small external inductor and capacitors to be used for minimal printed-circuit board (PCB) area. The supply current is typically only 0.1 $\mu$ A when the regulator is shut down.

### PWM Control Scheme

The ISL8011 employs the current-mode pulse-width modulation (PWM) control scheme for fast transient response and pulse-by-pulse current limiting. Figure 11 shows the block diagram. The current loop consists of the oscillator, the PWM comparator COMP, current sensing circuit, and the slope compensation for the current loop stability. The current sensing circuit consists of the resistance of the P-Channel MOSFET when it is turned on and the current sense amplifier (CSA1). The gain for the current sensing circuit is typically 0.4V/A. The control reference for the current loops comes from the error amplifier EAMP of the voltage loop.

The PWM operation is initialized by the clock from the oscillator. The P-Channel MOSFET is turned on at the beginning of a PWM cycle and the current in the MOSFET starts to ramp up. When the sum of the CSA1 and the compensation slope (0.675V/ $\mu$ s) reaches the control reference of the current loop, the PWM comparator COMP sends a signal to the PWM logic to turn off the P-MOSFET and to turn on the N-Channel MOSFET. The N-MOSFET stays on until the end of the PWM cycle. Figure 12 shows the typical operating waveforms during the PWM operation. The dotted lines illustrate the sum of the compensation ramp and the CSA1 output.

The output voltage is regulated by controlling the reference voltage to the current loop. The bandgap circuit outputs a 0.8V reference voltage to the voltage control loop. The feedback signal comes from the FB pin. The soft-start block only affects the operation during the start-up and will be discussed separately shortly. The error amplifier is a transconductance amplifier that converts the voltage error signal to a current output. The voltage loop is internally compensated with the 25pF and 400k $\Omega$  RC network. The maximum EAMP voltage output is precisely clamped to the bandgap voltage (1.172V).

### Overcurrent Protection

The overcurrent protection is realized by monitoring the CSA1 output with the OCP comparator, as shown in Figure 11. The current sensing circuit has a gain of 0.4V/A, from the N-MOSFET current to the CSA1 output. When the CSA1 output reaches 1V, which is equivalent to 2.5A for the switch current, the OCP comparator is tripped to turn off the P-MOSFET immediately.

### Short-Circuit Protection

A short-circuit protection (SCP) comparator monitors the FB pin voltage for output short-circuit protection. When the FB is lower than 0.2V, the SCP comparator forces the PWM oscillator frequency to drop to 1/3 of the normal operation value. This comparator is effective during start-up or an output short-circuit event.

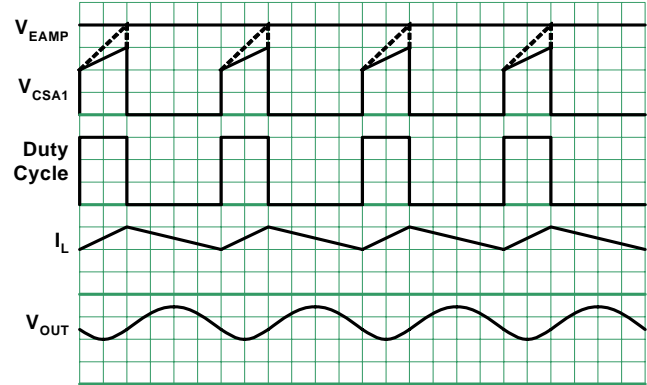

FIGURE 12. PWM OPERATION WAVEFORMS

### POR Signal

The ISL8011 offers a power-on reset (POR) signal for resetting the microprocessor at the power-up. When the output voltage is not within a power-good window, the POR pin outputs an open-drain low signal to reset the microprocessor. The output voltage is monitored through the FB pin. When the voltage of the monitored node is within the window of 0.736V and 0.864V, a power-good signal is issued to turn off the open-drain POR pin. The rising edge of the POR output is delayed by 200ms.

### UVLO

When the input voltage is below the undervoltage lock out (UVLO) threshold, the regulator is disabled.

### Soft Start-Up

The soft start-up eliminates the inrush current during the start-up. The soft-start block outputs a ramp reference to both the voltage loop and the current loop. The two ramps limit the inductor current rising speed as well as the output voltage speed so that the output voltage rises in a controlled fashion. At the very beginning of the start-up, the output voltage is less than 0.2V; hence the PWM operating frequency is 1/3 of the normal frequency. Figure 7 shows the start-up waveforms.

### Power MOSFETs

The power MOSFETs are optimized for best efficiency. The ON-resistance for the P-MOSFET is typically 150m $\Omega$  and the ON-resistance for the N-MOSFET is typically 150m $\Omega$ .

### 100% Duty Cycle

The ISL8011 features 100% duty cycle operation to maximize the battery life. When the battery voltage drops to

a level that the ISL8011 can no longer maintain the regulation at the output, the regulator completely turns on the P-MOSFET. The maximum drop out voltage under the 100% duty-cycle operation is the product of the load current and the ON-resistance of the P-MOSFET.

### Enable

The enable (EN) input allows user to control the turning on or off the regulator for purposes such as power-up sequencing. The the regulator is enabled, there is typically a 300µs delay for waking up the bandgap reference. Then the soft start-up begins. When the regulator is disabled, the P-MOSFET is turned off immediately and the N-MOSFET is turned on.

### Thermal Shut Down

The ISL8011 has built-in thermal protection. When the internal temperature reaches +150°C, the regulator is completely shut down. As the temperature drops to +130°C, the ISL8011 resumes operation by stepping through a soft start-up.

### V<sub>CC</sub> By-Passing

The V<sub>CC</sub> is voltage is the supply to the internal control circuit and is derived from the PVIN pin. An internal 5Ω resistor connects the two pins and also serves as an filtering resistor. An external 0.1µF ceramic capacitor is recommended to by-pass the V<sub>CC</sub> supply.

## Applications Information

### Output Inductor and Capacitor Selection

To consider state steady and transient operation, ISL8011 typically uses a 1.8µH output inductor. Higher or lower inductor values can be used to optimize the total converter system performance. For example, for higher output voltage 3.3V application, in order to decrease the inductor current ripple and output voltage ripple, the output inductor value can be increased as shown in Table 1. The inductor ripple current can be expressed as shown in Equation 1:

$$\Delta I = \frac{V_O \cdot \left(1 - \frac{V_O}{V_{IN}}\right)}{L \cdot f_S} \quad (\text{EQ. 1})$$

The inductor's saturation current rating needs be at least larger than the peak current. The maximum peak current of ISL8011 is 2.1A. The saturation current needs be over 2.1A for maximum output current application.

ISL8011 uses internal compensation network and the output capacitor value is dependent on the output voltage. The ceramic capacitor is recommended to be X5R or X7R. The recommended minimum output capacitor values are shown in Table 1.

TABLE 1. OUTPUT CAPACITOR VALUE vs V<sub>OUT</sub>

V <sub>OUT</sub>	C <sub>OUT</sub>	L
0.8V	10µF	1.0µH~2.2µH
1.2V	10µF	1.2µH~2.2µH
1.6V	10µF	1.8µH~2.2µH
1.8V	10µF	1.8µH~3.3µH
2.5V	10µF	1.8µH~3.3µH
3.3V	6.8µF	1.8µH~4.7µH
3.6V	4.7µF	1.8µH~4.7µH

In Table 1, the minimum output capacitor value is given for different output voltage to make sure the whole converter system stable. Due to the limitation on power dissipation when the regulator disable and discharge output capacitor, there is the maximum output capacitor value. The maximum output capacitor value is variable with the output voltage. The plot curve is shown in Figure 13.

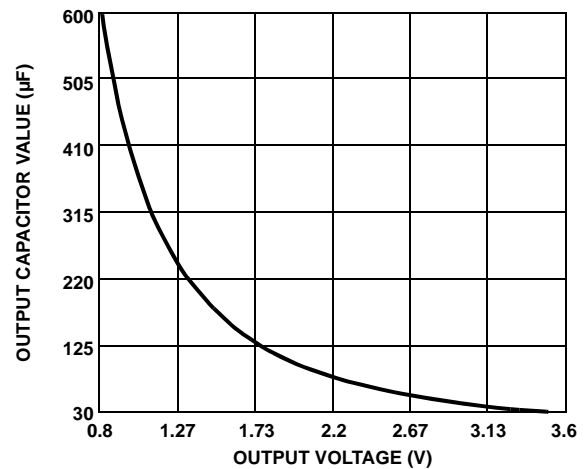

FIGURE 13. THE MAXIMUM CAP vs THE OUTPUT VOLTAGE

### Input Capacitor Selection

The main functions for the input capacitor are to provide decoupling of the parasitic inductance and to provide filtering function to prevent the switching current flowing back to the supply rail. A 10µF X5R or X7R ceramic capacitor is a good starting point for the input capacitor selection.

### Output Voltage Setting Resistor Selection

The resistors R<sub>2</sub> and R<sub>3</sub> shown in Figure 10 set the output voltage for the adjustable version. The output voltage can be calculated by using Equation 2:

$$V_O = 0.8 \cdot \left(1 + \frac{R_2}{R_3}\right) \quad (\text{EQ. 2})$$

where the 0.8V is the reference voltage. To minimize the accuracy impact on the output voltage, select the R<sub>2</sub> and R<sub>3</sub> no larger than 100kΩ.

## ***Layout Recommendation***

The layout is a very important converter design step to make sure the designed converter works well. For ISL8011 buck converter, the power loop is composed of the output inductor L, the output capacitor C<sub>OUT</sub>, Phase pin and PGND pin. It is necessary to make the power loop as small as possible. In order to make the output voltage regulate well and avoid the noise coupling from the power loop, SGND pin should be connected with PGND pin at the terminals of the load.

The heat of the IC is mainly dissipated through the thermal pad. Maximizing the copper area connected to the thermal pad is preferable. In addition, a solid ground plane is helpful for EMI performance.

Dual Flat No-Lead Plastic Package (DFN)

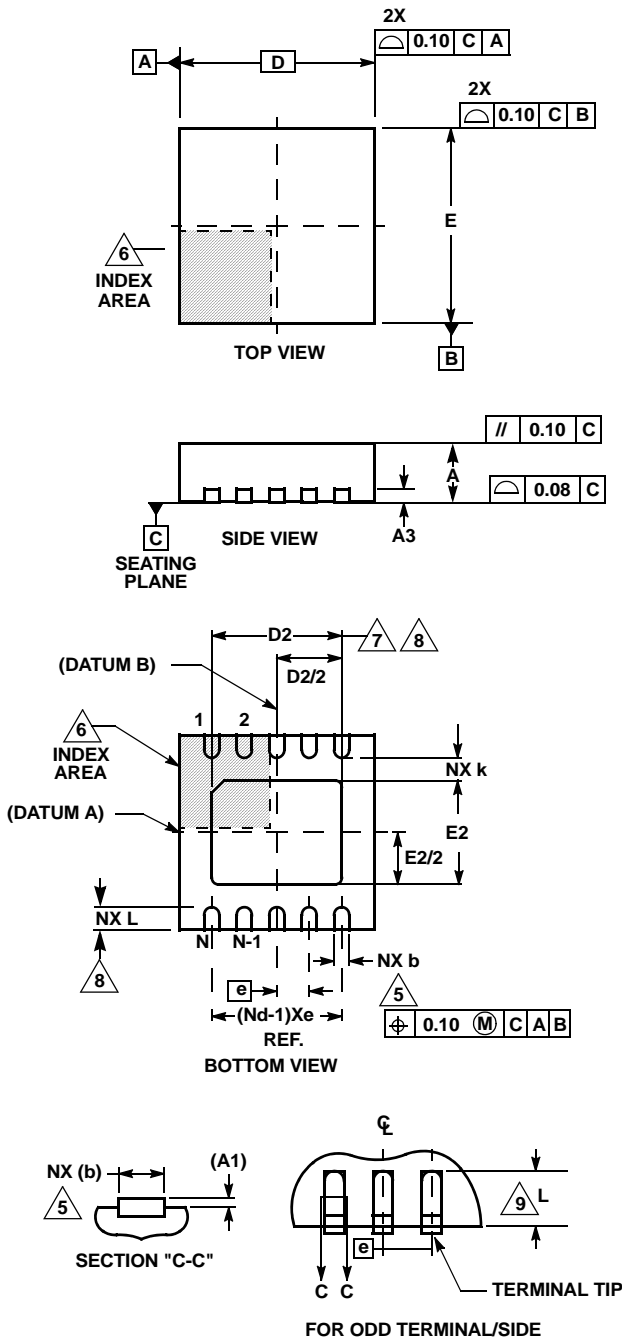

L10.3x3C

10 LEAD DUAL FLAT NO-LEAD PLASTIC PACKAGE

SYMBOL	MILLIMETERS			NOTES
	MIN	NOMINAL	MAX	
A	0.85	0.90	0.95	-
A1	-	-	0.05	-
A3	0.20 REF			-
b	0.20	0.25	0.30	5, 8
D	3.00 BSC			-
D2	2.33	2.38	2.43	7, 8
E	3.00 BSC			-
E2	1.59	1.64	1.69	7, 8
e	0.50 BSC			-
k	0.20	-	-	-
L	0.35	0.40	0.45	8
N	10			2
Nd	5			3

Rev. 1 4/06

NOTES:

1. Dimensioning and tolerancing conform to ASME Y14.5-1994.
2. N is the number of terminals.
3. Nd refers to the number of terminals on D.
4. All dimensions are in millimeters. Angles are in degrees.
5. Dimension b applies to the metallized terminal and is measured between 0.15mm and 0.30mm from the terminal tip.
6. The configuration of the pin #1 identifier is optional, but must be located within the zone indicated. The pin #1 identifier may be either a mold or mark feature.
7. Dimensions D2 and E2 are for the exposed pads which provide improved electrical and thermal performance.
8. Nominal dimensions are provided to assist with PCB Land Pattern Design efforts, see Intersil Technical Brief TB389.
9. COMPLIANT TO JEDEC MO-229-WEED-3 except for dimensions E2 & D2.

All Intersil U.S. products are manufactured, assembled and tested utilizing ISO9000 quality systems. Intersil Corporation's quality certifications can be viewed at [www.intersil.com/design/quality](http://www.intersil.com/design/quality)

Intersil products are sold by description only. Intersil Corporation reserves the right to make changes in circuit design, software and/or specifications at any time without notice. Accordingly, the reader is cautioned to verify that data sheets are current before placing orders. Information furnished by Intersil is believed to be accurate and reliable. However, no responsibility is assumed by Intersil or its subsidiaries for its use; nor for any infringements of patents or other rights of third parties which may result from its use. No license is granted by implication or otherwise under any patent or patent rights of Intersil or its subsidiaries.

For information regarding Intersil Corporation and its products, see [www.intersil.com](http://www.intersil.com)