

General Description

The AOD476 uses advanced trench technology and design to provide excellent $R_{DS(ON)}$ with low gate charge. This device is suitable for use in PWM, load switching and general purpose applications.

Features

V_{DS} (V) = 20V
 I_D = 25A (V_{GS} = 10V)
 $R_{DS(ON)}$ <21 m Ω (V_{GS} = 10V)
 $R_{DS(ON)}$ <28 m Ω (V_{GS} = 4.5V)
 $R_{DS(ON)}$ <79 m Ω (V_{GS} = 2.5V)

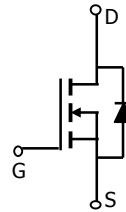

Absolute Maximum Ratings $T_A=25^\circ\text{C}$ unless otherwise noted

Parameter	Symbol	Maximum	Units
Drain-Source Voltage	V_{DS}	20	V
Gate-Source Voltage	V_{GS}	± 16	V
Continuous Drain Current	I_D	$T_C=25^\circ\text{C}^G$	25
		$T_C=100^\circ\text{C}$	20
Pulsed Drain Current ^C	I_{DM}	75	A
Avalanche Current ^C	I_{AR}	13	A
Repetitive avalanche energy $L=0.3\text{mH}^C$	E_{AR}	25	mJ
Power Dissipation ^B	P_D	$T_C=25^\circ\text{C}$	33.3
		$T_C=100^\circ\text{C}$	16.7
Power Dissipation ^A	P_{DSM}	$T_A=25^\circ\text{C}$	2.5
		$T_A=70^\circ\text{C}$	1.6
Junction and Storage Temperature Range	T_J, T_{STG}	-55 to 175	$^\circ\text{C}$

Thermal Characteristics

Parameter	Symbol	Typ	Max	Units
Maximum Junction-to-Ambient ^A	$R_{\theta JA}$	$t \leq 10\text{s}$	17	$^\circ\text{C/W}$
Maximum Junction-to-Ambient ^A		Steady-State	40	$^\circ\text{C/W}$
Maximum Junction-to-Case ^B	$R_{\theta JC}$	3.6	4.5	$^\circ\text{C/W}$

Electrical Characteristics (T_J=25°C unless otherwise noted)

Symbol	Parameter	Conditions	Min	Typ	Max	Units
STATIC PARAMETERS						
BV _{DSS}	Drain-Source Breakdown Voltage	I _D =250μA, V _{GS} =0V	20			V
I _{DSS}	Zero Gate Voltage Drain Current	V _{DS} =16V, V _{GS} =0V T _J =55°C			1 5	μA
I _{GSS}	Gate-Body leakage current	V _{DS} =0V, V _{GS} =±16V			100	nA
V _{GS(th)}	Gate Threshold Voltage	V _{DS} =V _{GS} , I _D =250μA	0.6	1.26	2	V
I _{D(ON)}	On state drain current	V _{GS} =10V, V _{DS} =5V	75			A
R _{DS(ON)}	Static Drain-Source On-Resistance	V _{GS} =10V, I _D =20A T _J =125°C		14 21	21	mΩ
		V _{GS} =4.5V, I _D =10A		20	28	
		V _{GS} =2.5V, I _D =4A		57	79	
g _{FS}	Forward Transconductance	V _{DS} =5V, I _D =20A		19		S
V _{SD}	Diode Forward Voltage	I _S =1A, V _{GS} =0V		0.77	1	V
I _S	Maximum Body-Diode Continuous Current ^G				30	A
DYNAMIC PARAMETERS						
C _{iss}	Input Capacitance	V _{GS} =0V, V _{DS} =10V, f=1MHz		900		pF
C _{oss}	Output Capacitance			162		pF
C _{rss}	Reverse Transfer Capacitance			105		pF
R _g	Gate resistance	V _{GS} =0V, V _{DS} =0V, f=1MHz		0.9	1.35	Ω
SWITCHING PARAMETERS						
Q _{g(10V)}	Total Gate Charge	V _{GS} =10V, V _{DS} =10V, I _D =20A		15	18	nC
Q _{g(4.5V)}	Total Gate Charge			7.2	9	nC
Q _{gs}	Gate Source Charge			1.8		nC
Q _{gd}	Gate Drain Charge			2.8		nC
t _{D(on)}	Turn-On DelayTime	V _{GS} =10V, V _{DS} =10V, R _L =0.5Ω, R _{GEN} =3Ω		4.5		ns
t _r	Turn-On Rise Time			9.2		ns
t _{D(off)}	Turn-Off DelayTime			18.7		ns
t _f	Turn-Off Fall Time		3.3		ns	
t _{rr}	Body Diode Reverse Recovery Time	I _F =20A, dI/dt=100A/μs		18		ns
Q _{rr}	Body Diode Reverse Recovery Charge	I _F =20A, dI/dt=100A/μs		9.5		nC

A: The value of R_{θJA} is measured with the device mounted on 1in² FR-4 board with 2oz. Copper, in a still air environment with T_A=25°C. The Power dissipation P_{DSM} is based on R_{θJA} and the maximum allowed junction temperature of 150°C. The value in any given application depends on the user's specific board design, and the maximum temperature of 175°C may be used if the PCB allows it.

B: The power dissipation P_D is based on T_{J(MAX)}=175°C, using junction-to-case thermal resistance, and is more useful in setting the upper dissipation limit for cases where additional heatsinking is used.

C: Repetitive rating, pulse width limited by junction temperature T_{J(MAX)}=175°C.

D: The R_{θJA} is the sum of the thermal impedance from junction to case R_{θJC} and case to ambient.

E: The static characteristics in Figures 1 to 6 are obtained using <300 μs pulses, duty cycle 0.5% max.

F: These curves are based on the junction-to-case thermal impedance which is measured with the device mounted to a large heatsink, assuming a maximum junction temperature of T_{J(MAX)}=175°C.

G: The maximum current rating is limited by bond-wires.

H: These tests are performed with the device mounted on 1 in² FR-4 board with 2oz. Copper, in a still air environment with T_A=25°C. The SOA curve provides a single pulse rating.

*This device is guaranteed green after data code 8X11 (Sep 1ST 2008).

Rev2: Oct. 2008

TYPICAL ELECTRICAL AND THERMAL CHARACTERISTICS

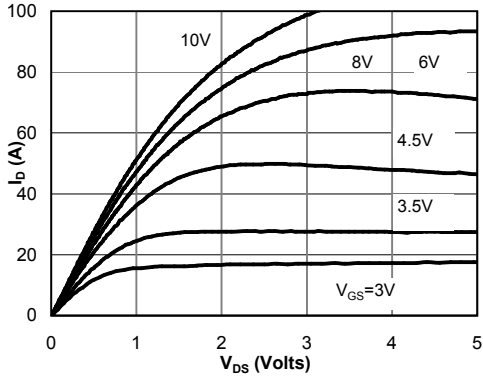

Fig 1: On-Region Characteristics

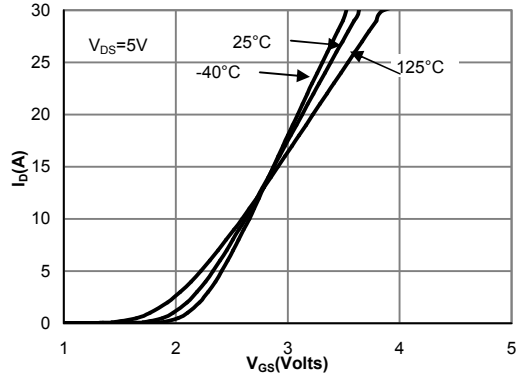

Figure 2: Transfer Characteristics

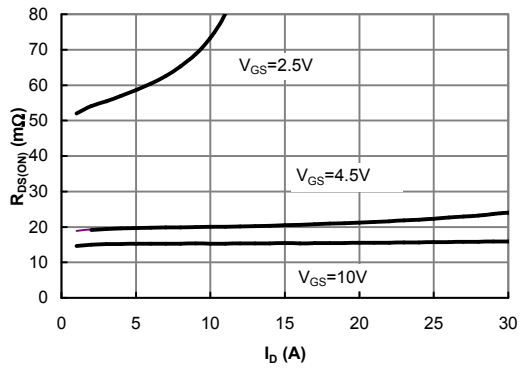

Figure 3: On-Resistance vs. Drain Current and Gate Voltage

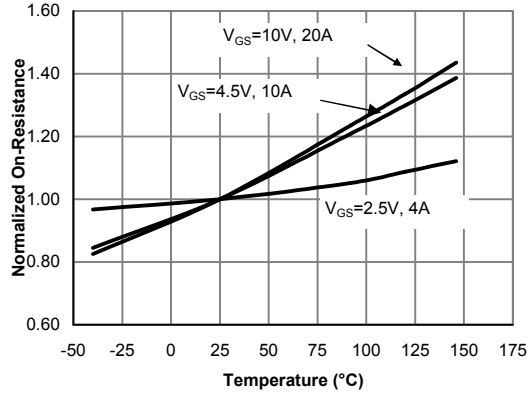

Figure 4: On-Resistance vs. Junction Temperature

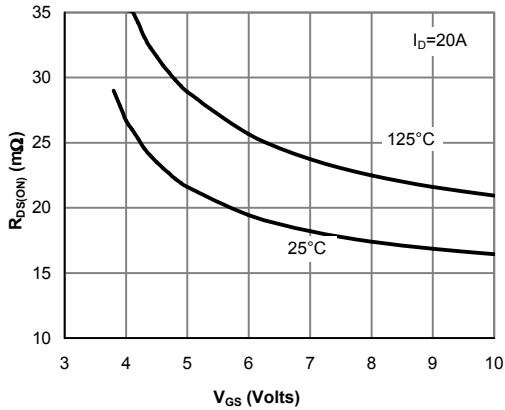

Figure 5: On-Resistance vs. Gate-Source Voltage

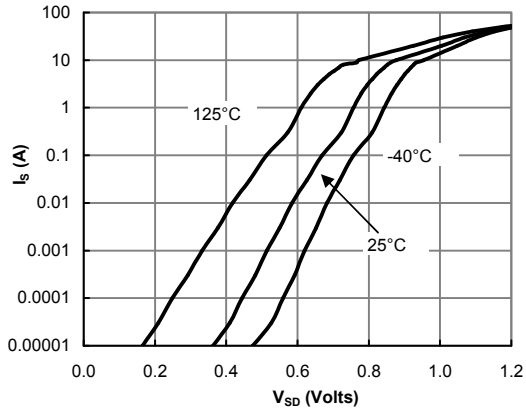

Figure 6: Body-Diode Characteristics

TYPICAL ELECTRICAL AND THERMAL CHARACTERISTICS

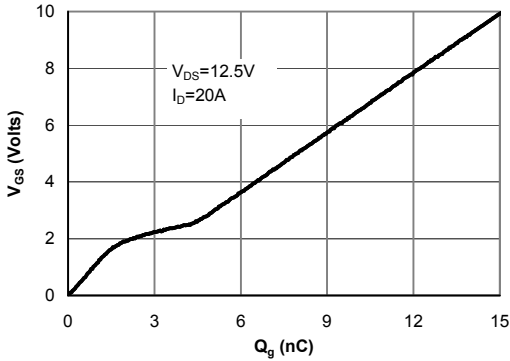

Figure 7: Gate-Charge Characteristics

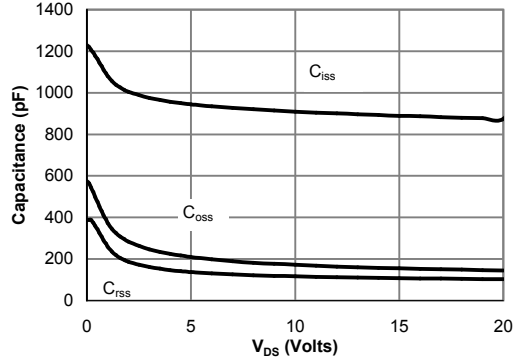

Figure 8: Capacitance Characteristics

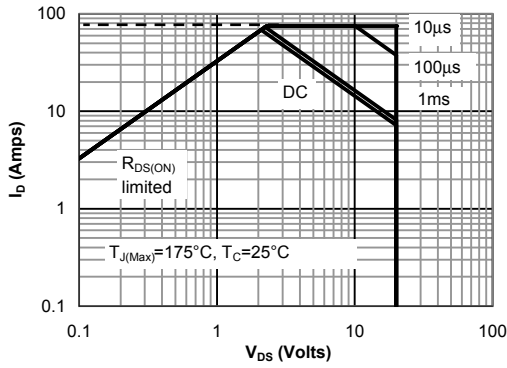

Figure 9: Maximum Forward Biased Safe Operating Area (Note F)

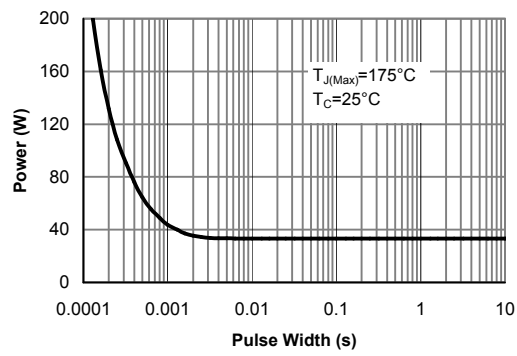

Figure 10: Single Pulse Power Rating Junction-to-Case (Note F)

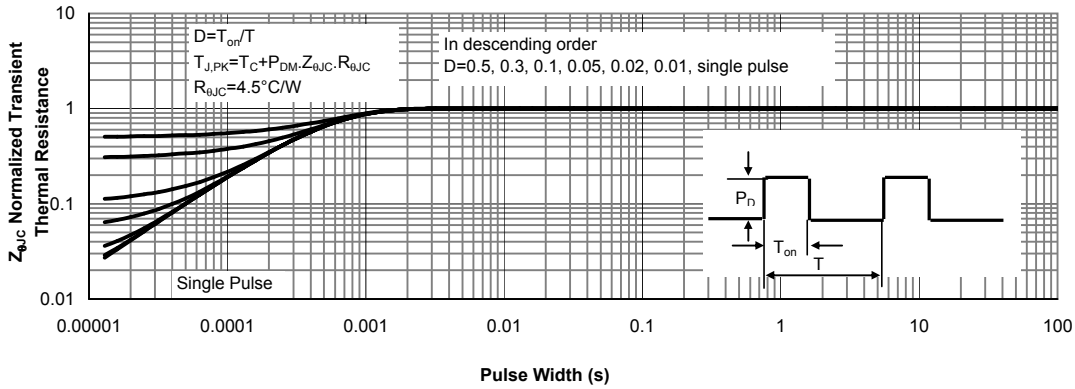

Figure 11: Normalized Maximum Transient Thermal Impedance (Note F)

TYPICAL ELECTRICAL AND THERMAL CHARACTERISTICS

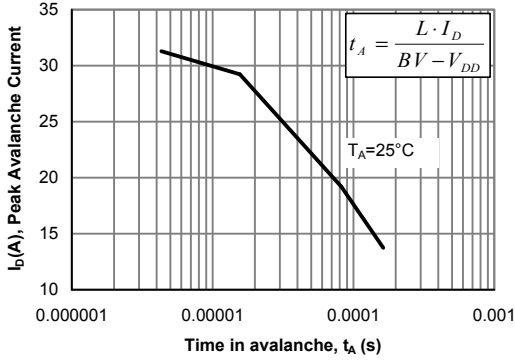

Figure 12: Single Pulse Avalanche capability

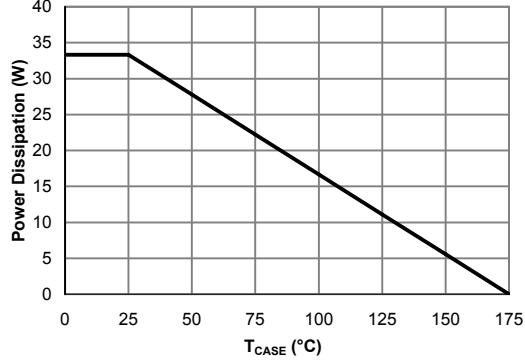

Figure 13: Power De-rating (Note B)

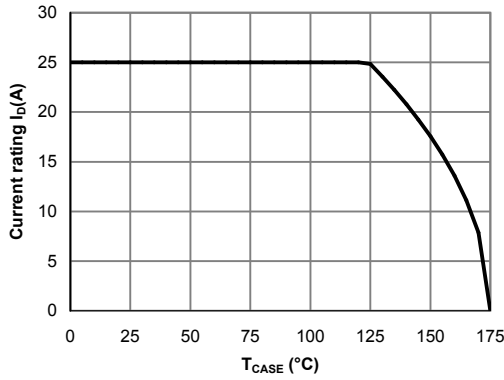

Figure 14: Current De-rating (Note B)

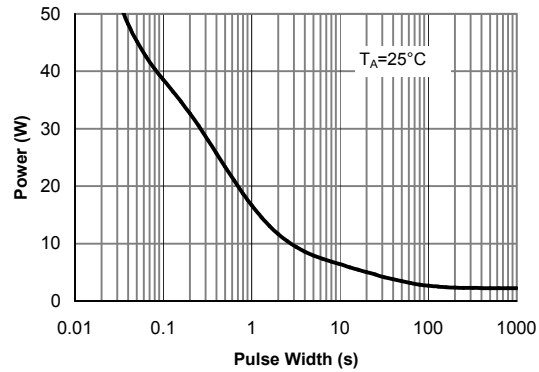

Figure 15: Single Pulse Power Rating Junction-to-Ambient (Note H)

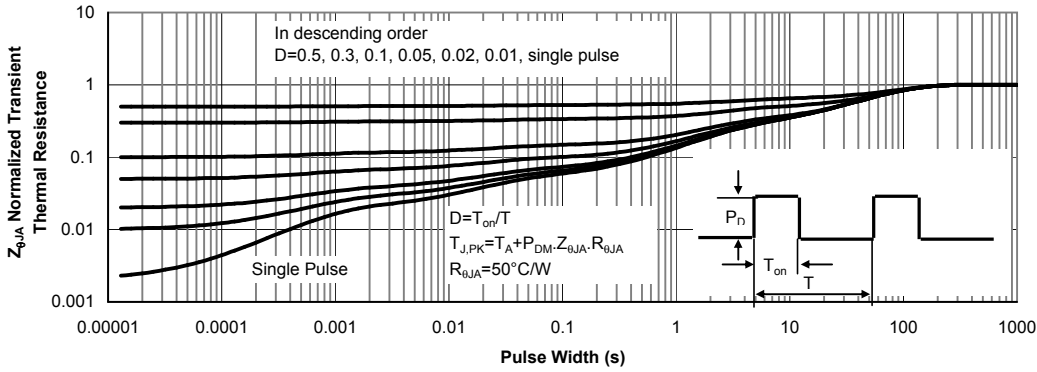
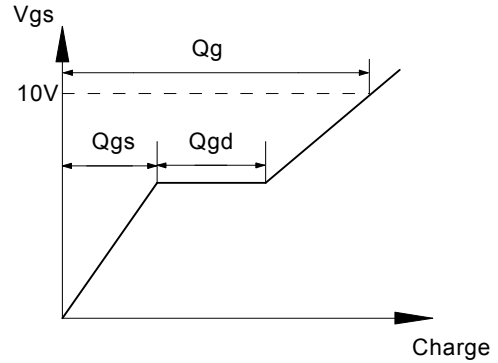
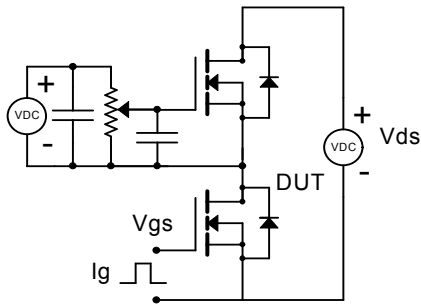
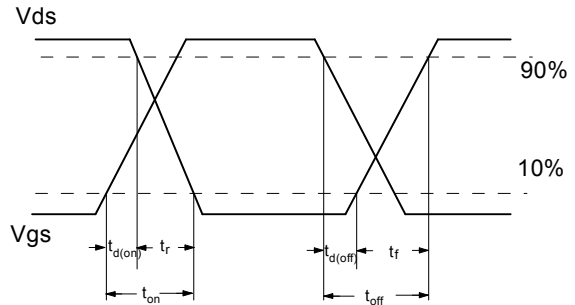
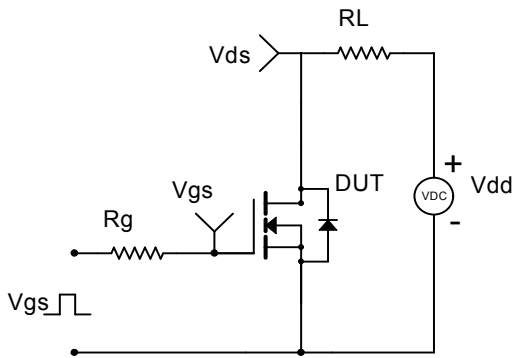

Figure 16: Normalized Maximum Transient Thermal Impedance (Note H)

Gate Charge Test Circuit & Waveform



Resistive Switching Test Circuit & Waveforms



Unclamped Inductive Switching (UIS) Test Circuit & Waveforms

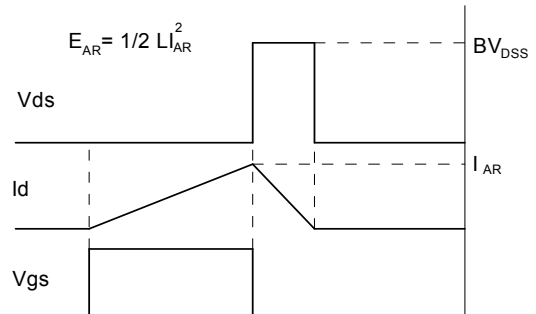
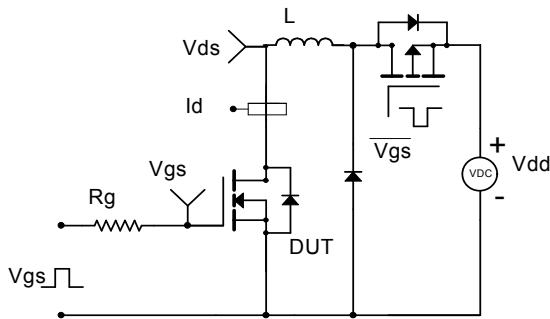

Diode Recovery Test Circuit & Waveforms

