

ULTRAFast RECOVERY POWER RECTIFIER

Description

The SF10S600D2 power rectifier is designed for use in switching power supplies, inverters, and as free-wheeling diode.

Feature

- Low forward voltage drop and leakage current
- Ultra fast reverse recovery time
- Low power loss and High efficiency
- Full lead (Pb)-free and RoHS compliant device

Applications

- Switching mode power supply
- Free-wheeling diode for motor application
- Polarity protection
- Power switching circuits

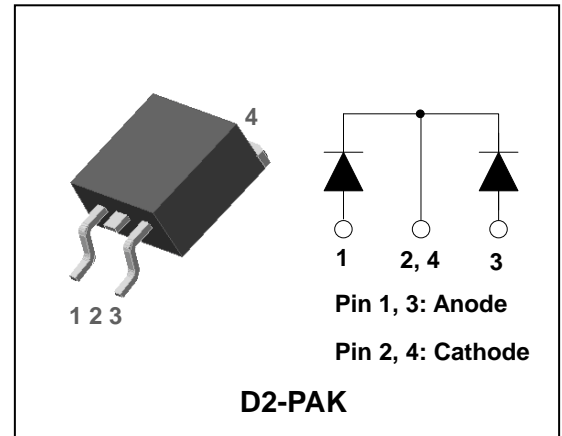

Product Characteristics

$I_{F(AV)}$	10A
V_{RRM}	600V
$V_{FM} @ T_j=125^{\circ}C$	1.68V
t_{rr}	35ns

Ordering Information

Device	Marking Code	Package	Packaging
SF10S600D2	SF10S600D2	D2-PAK	Tape & Reel

Marking Information

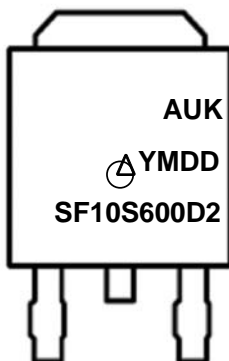

AUK = Manufacture Logo

Δ = Control Code of Manufacture

YMDD = Date Code Marking

- . Y = Year Code

- . M = Monthly Code

- . DD = Daily Code

SF10S600D2 = Specific Device Code

Absolute Maximum Ratings (Limiting Values)

Characteristic	Symbol	Value	Unit
Maximum repetitive reverse voltage Maximum working peak reverse voltage Maximum DC blocking voltage	V_{RRM} V_{RWM} V_R	600	V
Maximum average forward rectified current	$I_{F(AV)}$	10	A
Peak forward surge current 8.3ms single half sine-wave superimposed on rated load per diode	I_{FSM}	100	A
Storage temperature range	T_{stg}	-45°C to +150°C	°C
Maximum operating junction temperature	T_J	150	°C

Thermal Characteristics

Characteristic	Symbol	Value	Unit
Maximum thermal resistance junction to case	$R_{th(j-c)}$	3.0	°C/W

Electrical Characteristics

Characteristic	Symbol	Test Condition	Min.	Typ.	Max.	Unit	
Peak forward voltage drop	$V_{FM}^{(1)}$	$I_{FM} = 10A$	$T_j = 25^\circ C$	-	-	1.90	V
			$T_j = 125^\circ C$	-	-	1.68	V
Reverse leakage current	$I_{RM}^{(1)}$	$V_R = V_{RRM}$	$T_j = 25^\circ C$	-	-	20	uA
			$T_j = 125^\circ C$	-	-	200	uA
Reverse recovery time	t_{rr}	$I_F = 1A, di/dt = -100 A/us$	-	-	35	ns	
Junction capacitance	C_j	$V_R = 4V_{DC}, f=1MHz$	-	-	250	pF	

Note : (1) Pulse test : $t_p \leq 380 \mu s$, Duty cycle $\leq 2\%$

Rating and Characteristic Curves

Fig. 1) Typical Forward Characteristics

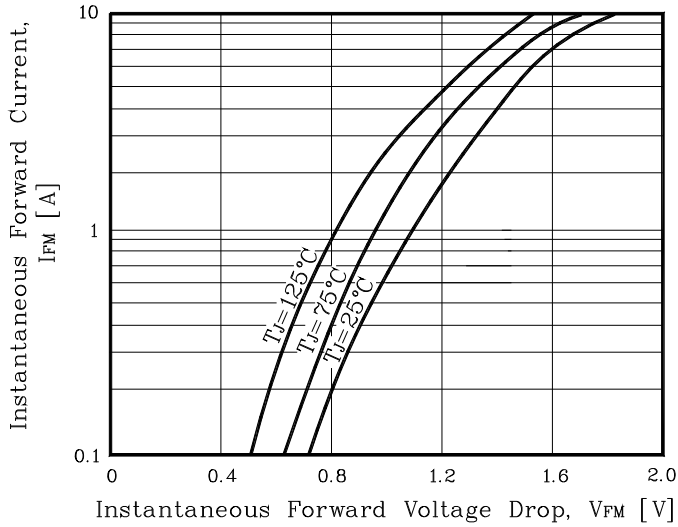

Fig. 2) Typical Reverse Characteristics

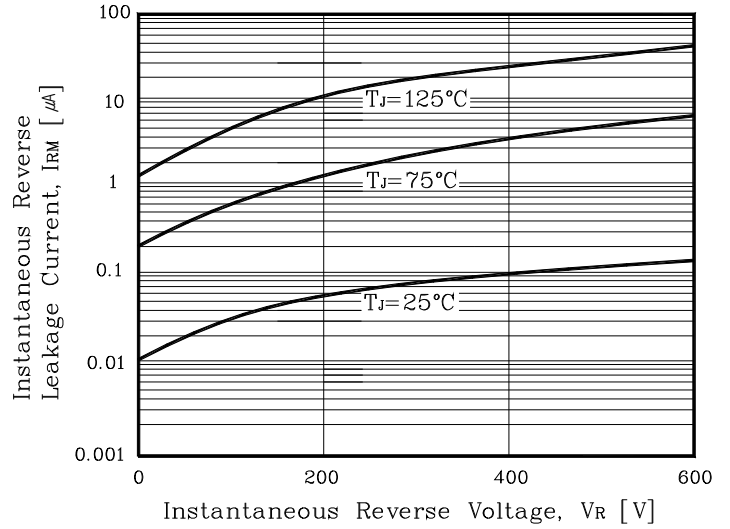

Fig. 3) Maximum Forward Derivative Curve

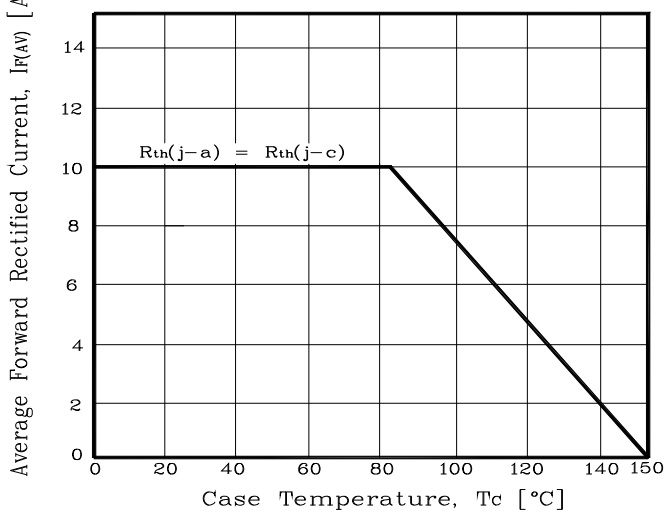

Fig. 4) Forward Power Dissipation

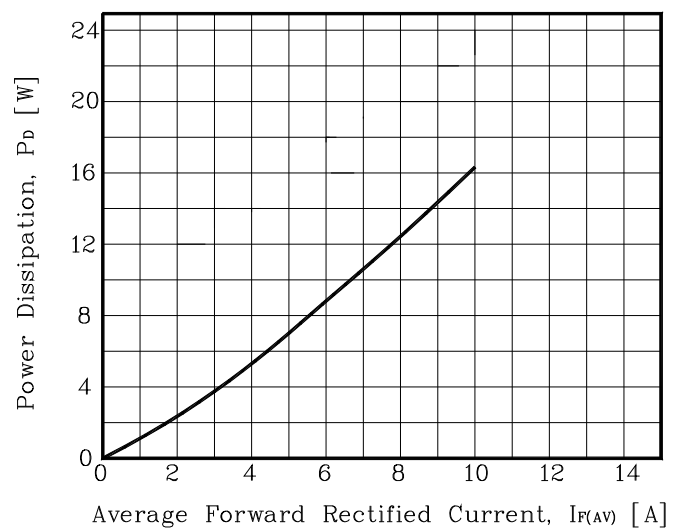

Fig. 5) Maximum Non-Repetitive Peak Forward Surge Current

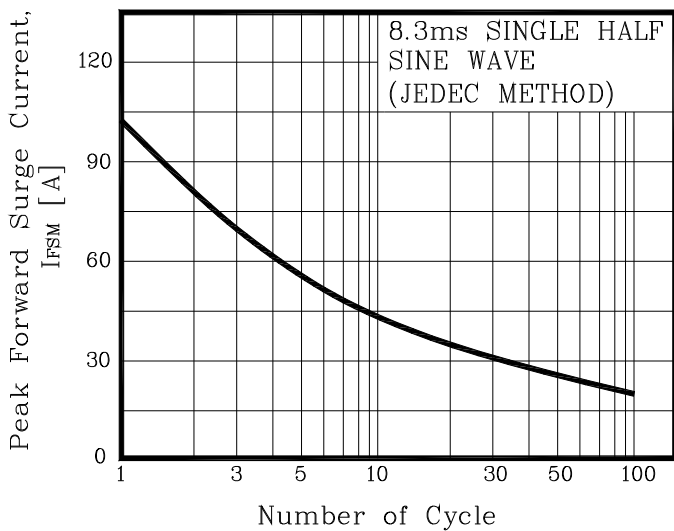
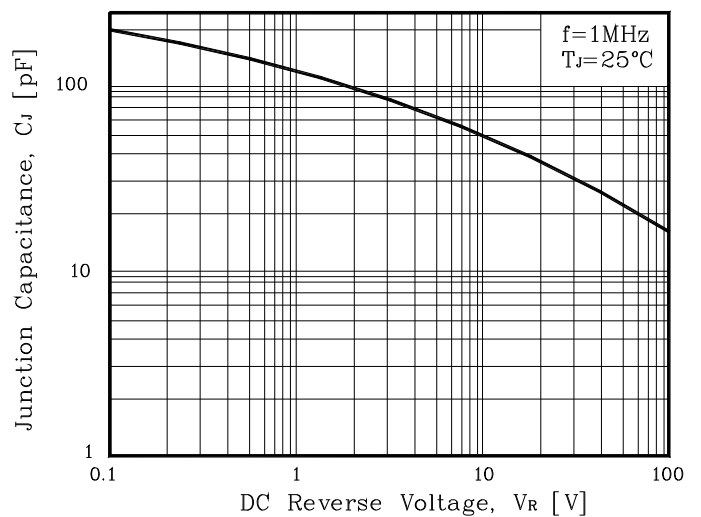
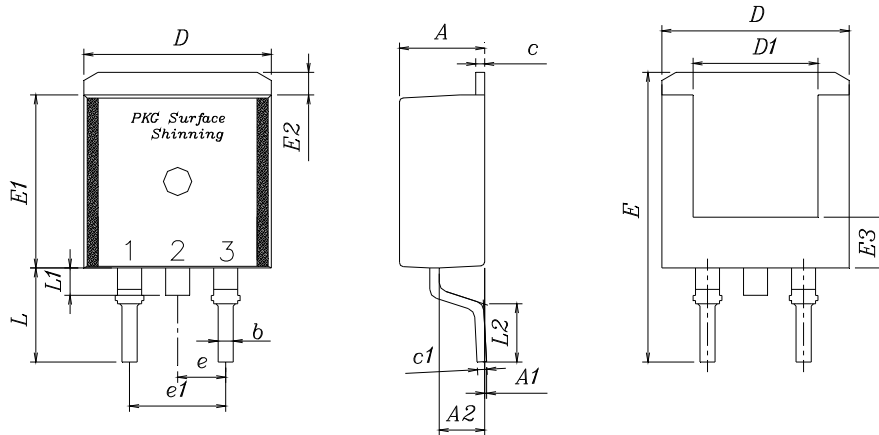

Fig. 6) Typical Junction Capacitance



Package Outline Dimension



SYMBOL	MILLIMETERS			NOTE
	MINIMUM	NOMINAL	MAXIMUM	
A	4.35	4.50	4.65	
A1	—	—	0.15	
A2	2.20	2.40	2.60	
b	0.70	0.80	0.90	
c	0.40	0.50	0.60	
c1	0.40	0.50	0.60	
D	9.80	10.00	10.20	
D1	6.40	6.60	6.80	
E	15.00	15.40	15.80	
E1	9.05	9.20	9.35	
E2	1.00	1.20	1.40	
E3	2.50	2.70	2.90	
e	2.34	2.54	2.74	
e1	4.88	5.08	5.28	
L	4.60	5.00	5.40	
L1	1.40	1.45	1.50	
L2	2.50	—	—	

※ Recommend PCB solder land (Unit: mm)

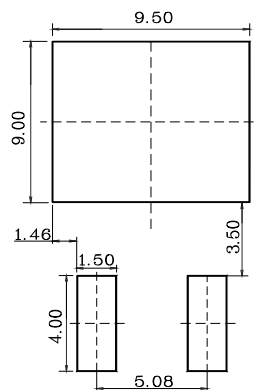

The AUK Corp. products are intended for the use as components in general electronic equipment (Office and communication equipment, measuring equipment, home appliance, etc.).

Please make sure that you consult with us before you use these AUK Corp. products in equipments which require high quality and / or reliability, and in equipments which could have major impact to the welfare of human life(atomic energy control, airplane, spaceship, transportation, combustion control, all types of safety device, etc.). AUK Corp. cannot accept liability to any damage which may occur in case these AUK Corp. products were used in the mentioned equipments without prior consultation with AUK Corp..

Specifications mentioned in this publication are subject to change without notice.