

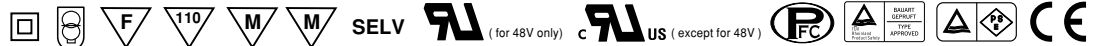

■ Features :

- Universal AC input / Full range
- Adjustable output voltage and current level
- Protections: Short circuit / Over current / Over voltage / Over temperature
- Cooling by free air convection
- Built-in constant current limiting circuit
- Fully isolated plastic case with terminal block style of I/O
- Built-in active PFC function, comply with EN61000-3-2 class C (Pin \geq 25W)
- Class II power unit, no FG
- Class 2 power unit
- 100% full load burn-in test
- High reliability
- Suitable for LED lighting and moving sign applications (Note.2)
- Compliance to worldwide safety regulations for lighting
- 2 years warranty

SPECIFICATION



MODEL	PLC-30-9	PLC-30-12	PLC-30-15	PLC-30-20	PLC-30-24	PLC-30-27	PLC-30-36	PLC-30-48		
OUTPUT	DC VOLTAGE	9V	12V	15V	20V	24V	27V	36V	48V	
	CONSTANT CURRENT REGION Note.6	6.3 ~ 9V	8.4 ~ 12V	10.5 ~ 15V	14 ~ 20V	16.8 ~ 24V	18.9 ~ 27V	25.2 ~ 36V	33.6 ~ 48V	
	RATED CURRENT	3.3A	2.5A	2A	1.5A	1.25A	1.12A	0.84A	0.63A	
	CURRENT RANGE	0 ~ 3.3A	0 ~ 2.5A	0 ~ 2A	0 ~ 1.5A	0 ~ 1.25A	0 ~ 1.12A	0 ~ 0.84A	0 ~ 0.63A	
	RATED POWER	29.7W	30W	30W	30W	30W	30.24W	30.24W	30.24W	
	RIPPLE & NOISE (max.) Note.2	2.6Vp-p	2Vp-p	2.6Vp-p	2.6Vp-p	2.4Vp-p	2.3Vp-p	3.6Vp-p	3.7Vp-p	
	VOLTAGE ADJ. RANGE Note.5	8.55 ~ 9.9V	11.4 ~ 13.2V	14.5 ~ 16.5V	19 ~ 22V	22.8 ~ 26.4V	25.65 ~ 29.7V	34.2 ~ 39.6V	45.6 ~ 52.8V	
	CURRENT ADJ. RANGE Note.5	2.475 ~ 3.399A	1.875 ~ 2.575A	1.5 ~ 2.06A	1.125 ~ 1.545A	0.938 ~ 1.288A	0.84 ~ 1.1536A	0.63 ~ 0.865A	0.473 ~ 0.649A	
	VOLTAGE TOLERANCE Note.3	$\pm 10\%$								
	LINE REGULATION	$\pm 3.0\%$								
LOAD REGULATION	$\pm 5.0\%$									
SETUP TIME	2000ms / 230VAC 3000ms / 115VAC at full load									
INPUT	VOLTAGE RANGE Note.4	90 ~ 264VAC 127 ~ 370VDC								
	FREQUENCY RANGE	47 ~ 63Hz								
	POWER FACTOR (Typ.)	PF>0.95/115VAC, PF>0.9/230VAC at full load (Please refer to "Power Factor Characteristic" curve)								
	EFFICIENCY (Typ.)	80%	82.5%	83.5%	84%	84%	84.5%	85%	85.5%	
	AC CURRENT (Typ.)	0.4A/115VAC 0.2A/230VAC								
	INRUSH CURRENT (max.)	40A/230VAC								
	LEAKAGE CURRENT	<0.5mA / 240VAC								
PROTECTION	OVER CURRENT	100 ~ 110% Protection type : Constant current limiting, recovers automatically after fault condition is removed								
	SHORT CIRCUIT	Hiccup mode, recovers automatically after fault condition is removed.								
	OVER VOLTAGE	10 ~ 14V	14 ~ 16V	17 ~ 22V	23 ~ 26V	27 ~ 34V	31 ~ 35V	40 ~ 50V	53 ~ 63V	
	OVER TEMPERATURE	95°C $\pm 10^\circ\text{C}$ (TSW1) Protection type : Shut down o/p voltage, re-power on to recover								
ENVIRONMENT	WORKING TEMP.	-30 ~ +50°C (Refer to "Derating Curve")								
	WORKING HUMIDITY	20 ~ 95% RH non-condensing								
	STORAGE TEMP., HUMIDITY	-40 ~ +80°C, 10 ~ 95% RH								
	TEMP. COEFFICIENT	$\pm 0.06\%/^\circ\text{C}$ (0 ~ 50°C)								
	VIBRATION	10 ~ 500Hz, 2G 12min./1cycle, period for 72min. each along X, Y, Z axes								
SAFETY & EMC	SAFETY STANDARDS	UL1310, TUV EN61347-1, EN61347-2-13, CAN/CSA C22.2 No. 223-M91(except for 48V), J61347-1, J61347-2-13 approved								
	WITHSTAND VOLTAGE	I/P-O/P:3.75KVAC								
	ISOLATION RESISTANCE	I/P-O/P:100M Ohms / 500VDC / 25°C / 70% RH								
	EMC EMISSION	Compliance to EN55015, EN61000-3-2 Class C (Pin \geq 25W), Class D (>70% load) ; EN61000-3-3								
OTHERS	EMC IMMUNITY	Compliance to EN61000-4-2,3,4,5,6,8,11, EN55024, EN61547, light industry level, criteria B								
	MTBF	625.5Khrs min. MIL-HDBK-217F (25°C)								
NOTE	DIMENSION	160*46*30mm (L*W*H)								
	PACKING	0.2Kg; 70pcs/15Kg/0.96CUFT								

1. All parameters NOT specially mentioned are measured at 230VAC input, rated load and 25°C of ambient temperature.
2. Ripple & noise are measured at 20MHz of bandwidth by using a 12" twisted pair-wire terminated with a 0.1uf & 47uf parallel capacitor.
3. Tolerance : includes set up tolerance, line regulation and load regulation.
4. Derating may be needed under low input voltage. Please check the static characteristics for more details.
5. Output voltage can be adjusted through the SVR1 on the PCB; limit of output constant current level can be adjusted through the SVR2 on the PCB.
6. Constant current operation region is within 70% ~100% rated output voltage. This is the suitable operation region for LED related applications, but please reconfirm special electrical requirements for some specific system design.
7. The power supply is considered as a component that will be operated in combination with final equipment. Since EMC performance will be affected by the complete installation, the final equipment manufacturers must re-qualify EMC Directive on the complete installation again.
8. Direct connecting to LEDs is suggested, but is not suitable for using additional drivers.

Mechanical Specification

Case No. 990A Unit:mm

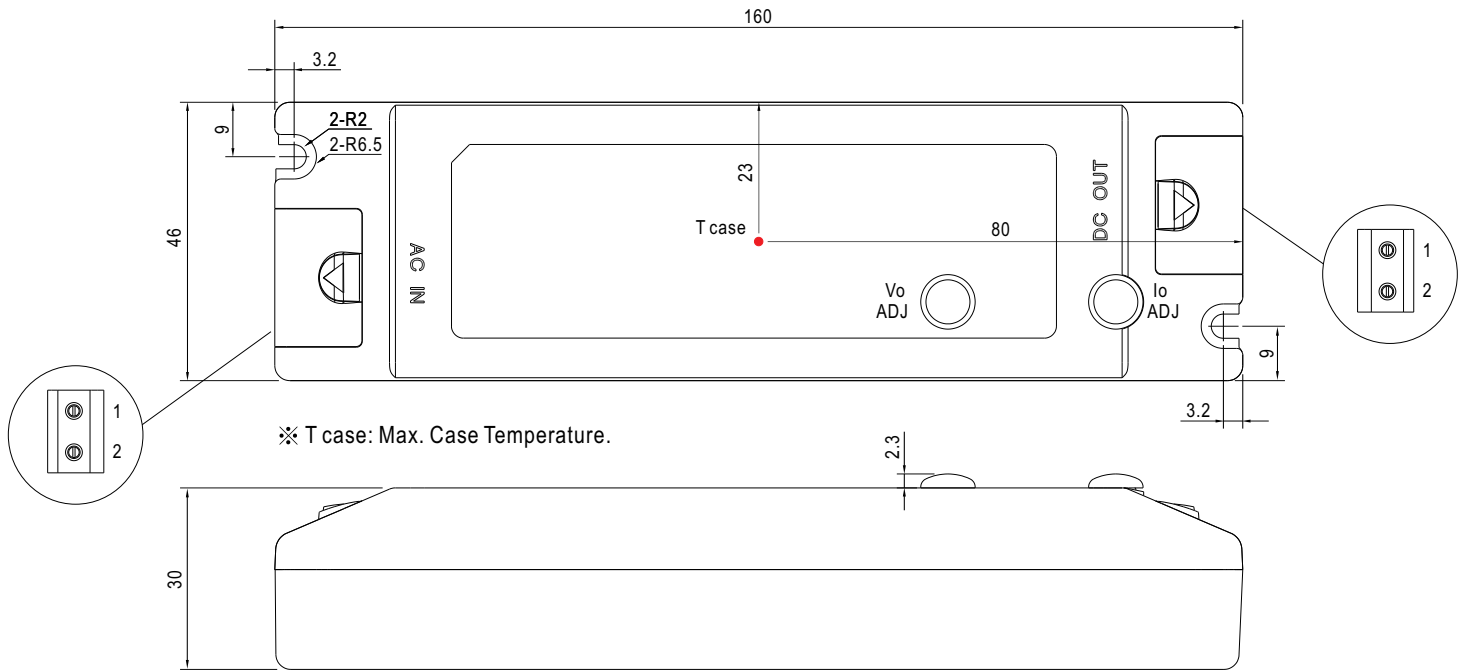

Block Diagram

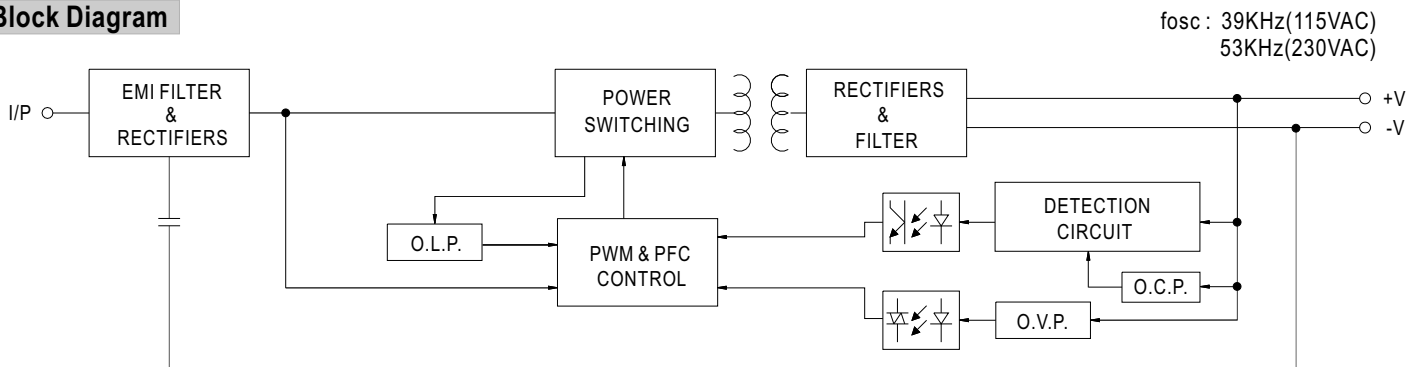

Derating Curve

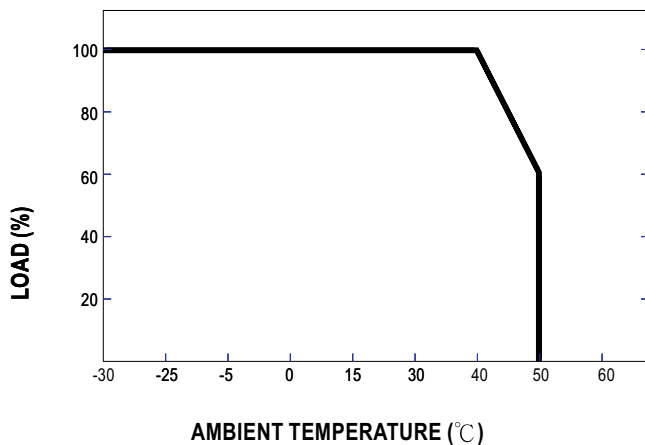

Static Characteristics

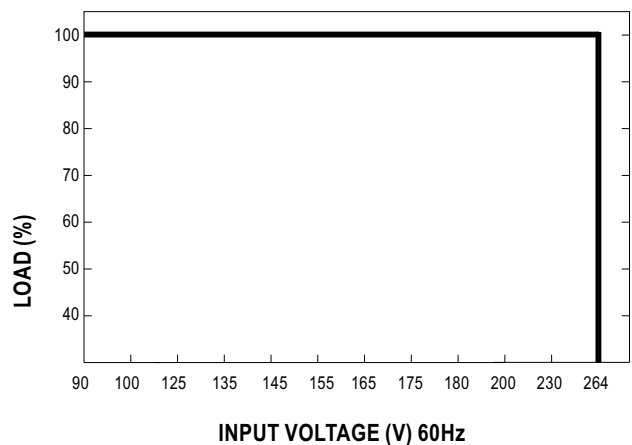

Power Factor Characteristic

Constant Current Mode

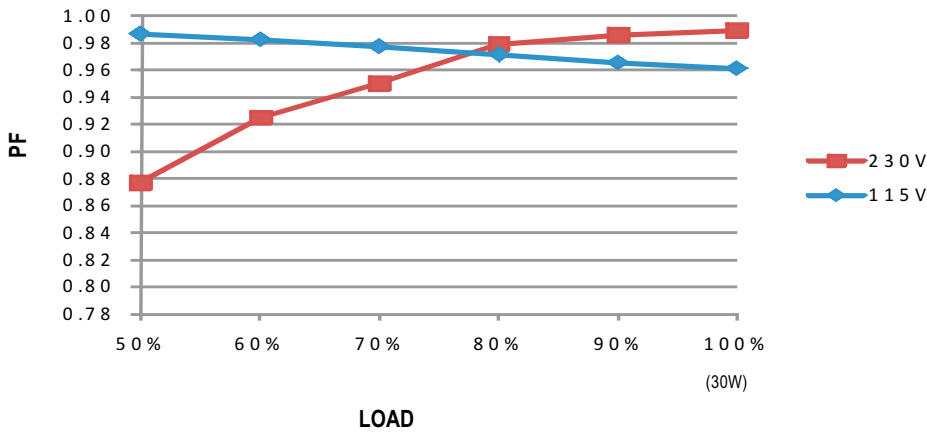

EFFICIENCY vs LOAD (48V Model)

PLC-30 series possess superior working efficiency that up to 85.5% can be reached in field applications.

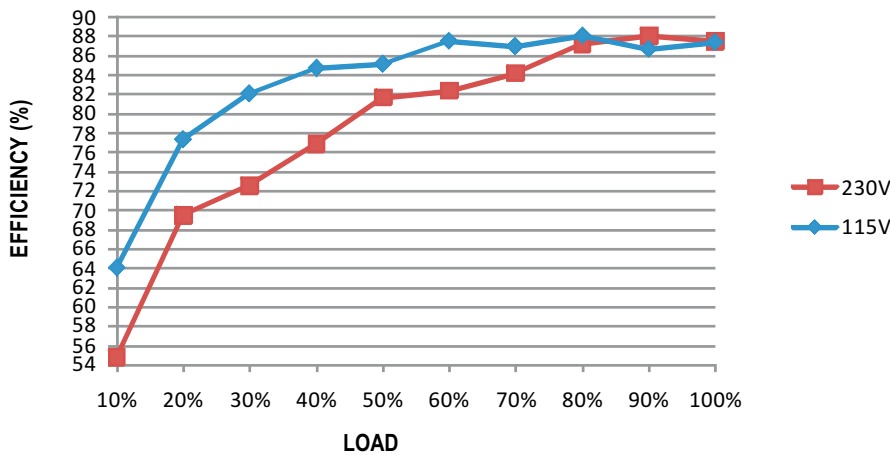

DRIVING METHODS OF LED MODULE

This LED power supply is suggested to work in constant current mode area (CC) to drive the LEDs.

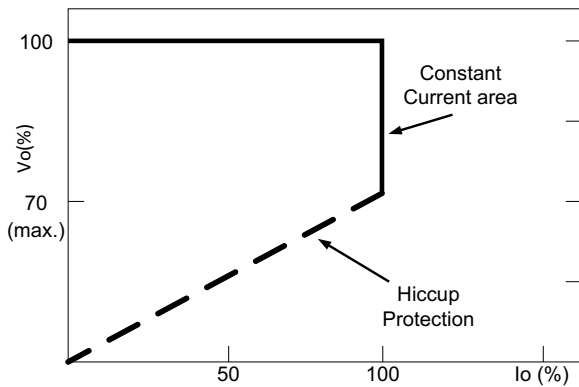

Typical LED power supply I-V curve