



Leaded Oscillator, TCXO, TCVCXO  
Metal Package, Full Size DIP



I123/I124/I323/I324 Series

**Product Features:**

Available in Both Clipped Sinewave and HCMOS Output Levels  
Compatible with Leadfree Processing

**Applications:**

Base Station  
IP  
WiMax/Wlan  
General Purpose

<b>Frequency</b> I123/I323 I124/I324	9.600 Mhz to 40 Mhz 1.000 Mhz to 40 Mhz
<b>Output Level</b> Clipped Sinewave HCMOS	1.0 V p-p Min. '0'=0.1 VCC Max., '1'=0.9Vcc Min.
<b>Output Load</b> Clipped Sinewave HCMOS	20K Ohms / 10 pF 15pF
<b>Duty Cycle (HCMOS)</b>	50% ±10%
<b>Rise / Fall Time (HCMOS)</b>	10 nS Max.
<b>Frequency Stability</b>	See Frequency Stability Table
<b>Frequency Tolerance @ 25° C</b>	Included in Stability Tolerance
<b>Aging</b>	± 1 ppm / Year Max.
<b>Supply Voltage</b>	See Supply Voltage Table , tolerance ± 5%
<b>Current</b>	3.0 mA Max. (Clipped Sinewave) 20.0 mA Max. (HCMOS)
<b>Voltage Control (I321/ I322)</b>	1.65 VDC ± 1.5 VDC, ± 5.0 ppm Min. for Vcc = 3.3 VDC 2.5 VDC ± 2.0 VDC, ± 5.0 ppm Min. for Vcc = 5.0 VDC
<b>Slope</b>	Positive
<b>Operating</b>	See Operating Temperature Table
<b>Storage</b>	-40° C to +85° C

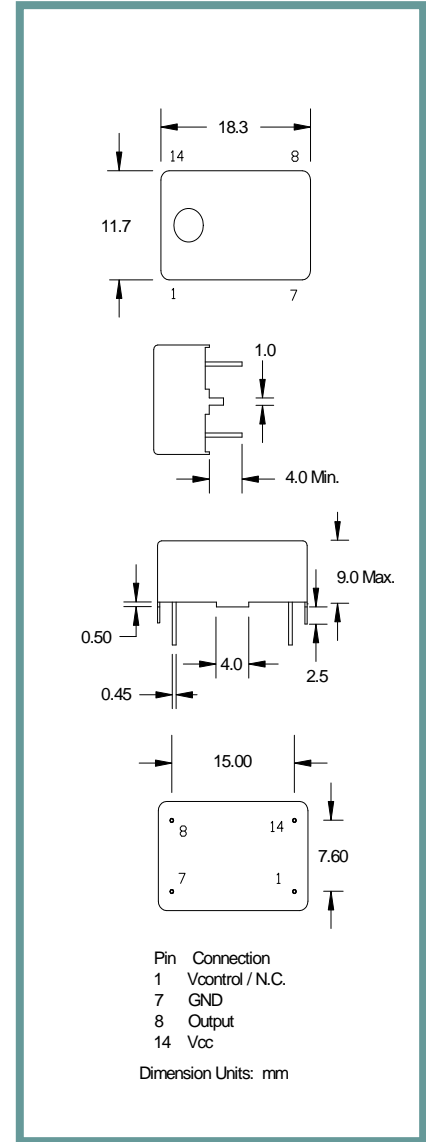

Part Number Guide		Sample Part Number: I123-1Q3-20.000 Mhz		
Package	Operating Temperature	Frequency Stability vs Temperature	Supply Voltage	Frequency
I123 (Clipped Sinewave TCXO) I124 (HCMOS TCXO) I323 (Clipped Sinewave TCVCXO) I324 (HCMOS TCVCXO)	7 = 0° C to +50° C	**O = ±1.5 ppm	3 = 3.3 V	- 20.000 Mhz
	1 = 0° C to +70° C	**P = ±2.0 ppm	5 = 5.0 V	
	3 = -20° C to +70° C	Q = ±2.5 ppm		
	2 = -40° C to +85° C	R = ±3.0 ppm		
		J = ±5.0 ppm		

NOTE: A 0.01 µF bypass capacitor is recommended between Vcc (pin 4) and GND (pin 2) to minimize power supply noise.  
\*\* Not available for all temperature ranges.



Leaded Oscillator, TCXO, TCVCXO  
Metal Package, Full Size DIP



I123/I124/I323/I324 Series

**Pb Free Solder Reflow Profile:**

**Typical Application:**

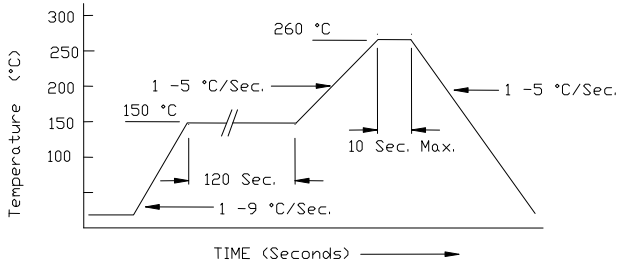

\*Units are backward compatible with 240C reflow processes

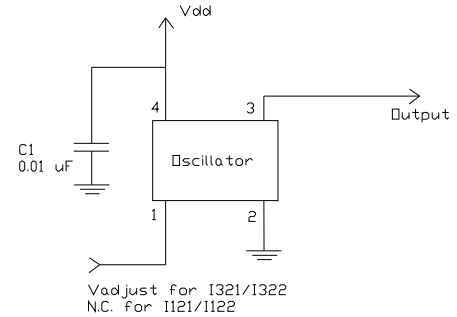

**Package Information:**

MSL = 2a  
Termination = e1 (Sn / Cu / Ag over Ni over Kovar base metal).

**Environmental Specifications**

Thermal Shock	MIL-STD-883, Method 1011, Condition A
Moisture Resistance	MIL-STD-883, Method 1004
Mechanical Shock	MIL-STD-883, Method 2002, Condition B
Mechanical Vibration	MIL-STD-883, Method 2007, Condition A
Resistance to Soldering Heat	J-STD-020C, Table 5-2 Pb-free devices (except 2 cycles max)
Hazardous Substance	Pb-Free / RoHS / Green Compliant
Solderability	JESD22-B102-D Method 2 (Preconditioning E)
Terminal Strength	MIL-STD-883, Method 2004, Test Condition D
Gross Leak	MIL-STD-883, Method 1014, Condition C
Fine Leak	MIL-STD-883, Method 1014, Condition A2, R1=2x10 <sup>-8</sup> atm cc/s
Solvent Resistance	MIL-STD-202, Method 215

**Marking**

Line 1: ILSI and Date Code  
Line 2: IXXX-XXX (Part Number detail = IXXX-XXX-Freq.)  
Line 3: Frequency