

Bi-Directional Triode Thyristor

Features

- ◆ Repetitive Peak Off-State Voltage : 600V
- ◆ R.M.S On-State Current ($I_{T(RMS)} = 1.5 \text{ A}$)
- ◆ High Commutation dv/dt

General Description

This device is suitable for low power AC switching application, phase control application such as fan speed and temperature modulation control, lighting control and static switching relay.

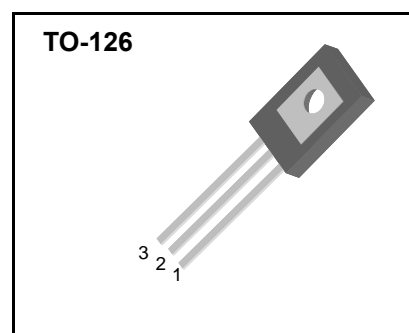
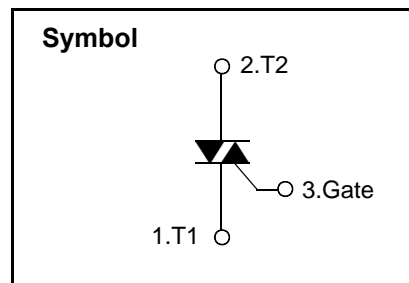

Absolute Maximum Ratings ($T_J = 25^\circ\text{C}$ unless otherwise specified)

Symbol	Parameter	Condition	Ratings	Units
V_{DRM}	Repetitive Peak Off-State Voltage		600	V
$I_{T(RMS)}$	R.M.S On-State Current	$T_C = 116^\circ\text{C}$	1.5	A
I_{TSM}	Surge On-State Current	One Cycle, 50Hz/60Hz, Peak, Non-Repetitive	13/15	A
I^2t	I^2t	$t = 10\text{ms}$	0.5	A^2s
P_{GM}	Peak Gate Power Dissipation		1.0	W
$P_{G(AV)}$	Average Gate Power Dissipation	Over any 20ms period	0.1	W
I_{GM}	Peak Gate Current		0.5	A
V_{GM}	Peak Gate Voltage		6.0	V
T_J	Operating Junction Temperature		- 40 ~ 125	$^\circ\text{C}$
T_{STG}	Storage Temperature		- 40 ~ 150	$^\circ\text{C}$

STR2A60

Electrical Characteristics

Symbol	Items		Conditions	Ratings			Unit
				Min.	Typ.	Max.	
I_{DRM}	Repetitive Peak Off-State Current		$V_D = V_{DRM}$, Single Phase, Half Wave $T_J = 125\text{ }^\circ\text{C}$	—	—	0.5	mA
V_{TM}	Peak On-State Voltage		$I_T = 2.1\text{ A}$, Inst. Measurement	—	—	1.6	V
I_{GT1}^+	I	Gate Trigger Current	$V_D = 6\text{ V}$, $R_L = 10\text{ }\Omega$	—	—	20	mA
I_{GT1}^-	II			—	—	20	
I_{GT3}^-	III			—	—	20	
V_{GT1}^+	I	Gate Trigger Voltage	$V_D = 6\text{ V}$, $R_L = 10\text{ }\Omega$	—	—	1.5	V
V_{GT1}^-	II			—	—	1.5	
V_{GT3}	III			—	—	1.5	
V_{GD}	Non-Trigger Gate Voltage		$T_J = 125\text{ }^\circ\text{C}$, $V_D = 1/2 V_{DRM}$	0.2	—	—	V
$(dv/dt)_c$	Critical Rate of Rise Off-State Voltage at Commutation		$T_J = 125\text{ }^\circ\text{C}$, $[di/dt]_c = -0.75\text{ A/ms}$, $V_D = 2/3 V_{DRM}$	5.0	—	—	V/ μs
I_H	Holding Current			—	5	—	mA
$R_{th(j-c)}$	Thermal Impedance		Junction to case	—	—	3.5	$^\circ\text{C/W}$



Fig 1. Gate Characteristics

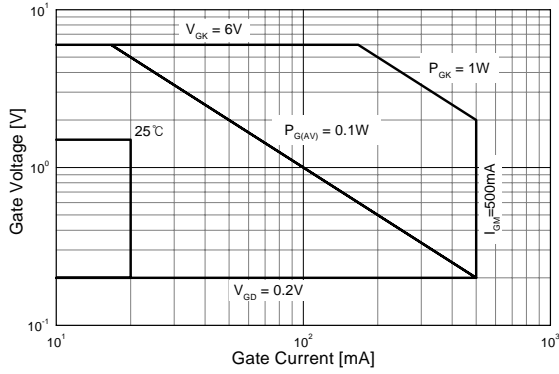

Fig 2. On-State Voltage

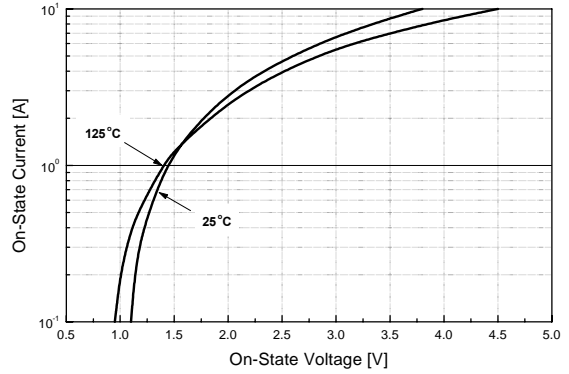

Fig 3. On State Current vs. Maximum Power Dissipation

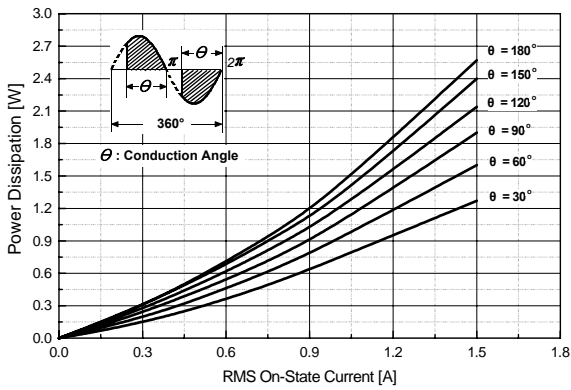

Fig 4. On State Current vs. Allowable Case Temperature

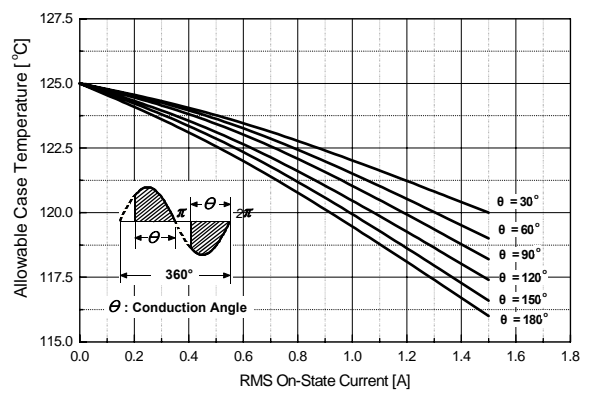

Fig 5. Surge On-State Current Rating (Non-Repetitive)

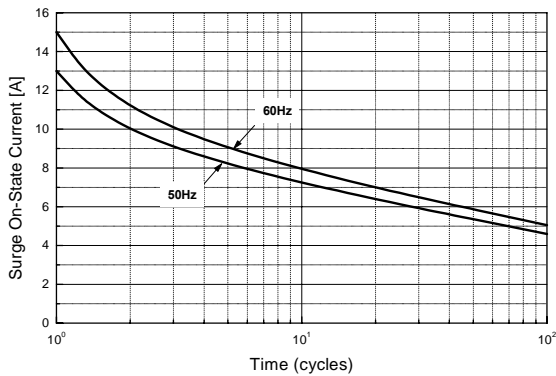
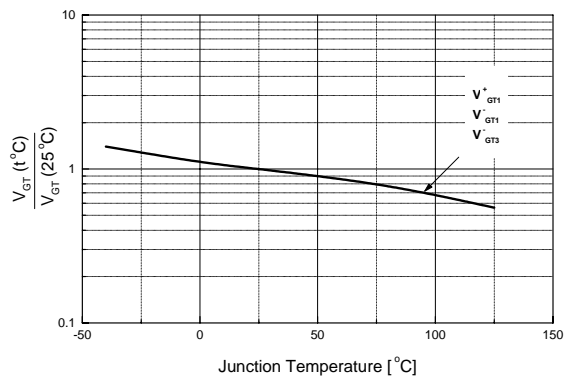

Fig 6. Gate Trigger Voltage vs. Junction Temperature



STR2A60

Fig 7. Gate Trigger Current vs. Junction Temperature

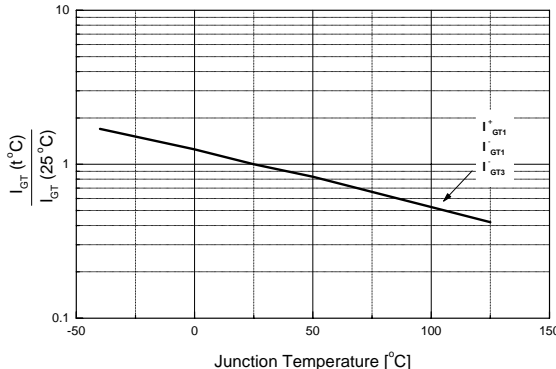

Fig 8. Transient Thermal Impedance

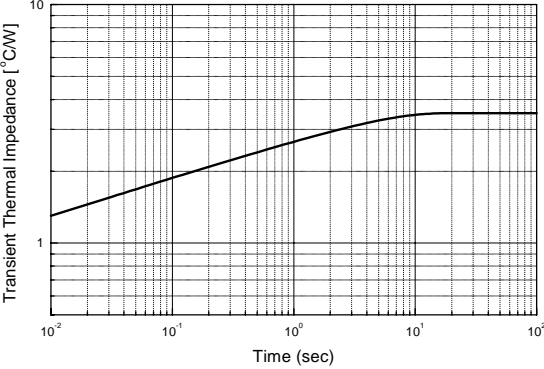
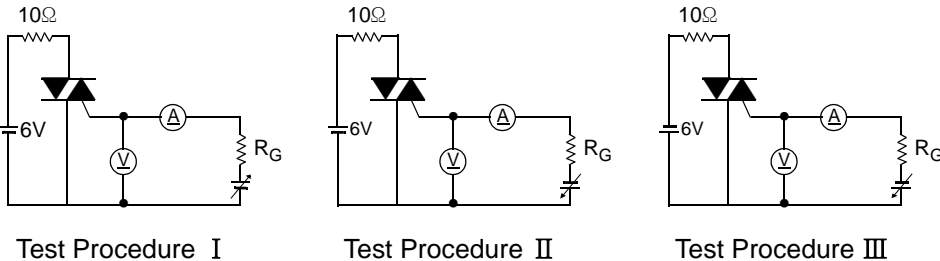

Fig 9. Gate Trigger Characteristics Test Circuit



STR2A60

TO-126 Package Dimension

Dim.	mm			Inch		
	Min.	Typ.	Max.	Min.	Typ.	Max.
A	7.5		7.9	0.295		0.311
B	10.8		11.2	0.425		0.441
C	14.2		14.7	0.559		0.579
D	2.7		2.9	0.106		0.114
E		3.8			0.150	
F		2.5			0.098	
G	1.2		1.5	0.047		0.059
H		2.3			0.091	
I		4.6			0.181	
J	0.48		0.62	0.019		0.024
K	0.7		0.86	0.028		0.034
L		1.4			0.055	
ϕ		3.2			0.126	

