



Micro Commercial Components
 21201 Itasca Street Chatsworth
 CA 91311
 Phone: (818) 701-4933
 Fax: (818) 701-4939

MBR12020 THRU MBR120100

120 Amp Schottky Barrier Rectifier 20 to 100 Volts

Features

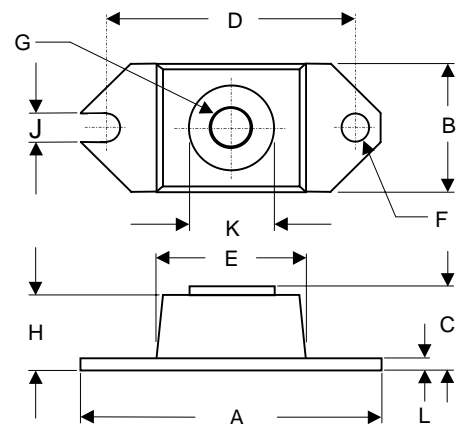
- Metal of siliconrectifier, majonty carrier conducton
- Guard ring for transient protection
- Low power loss high efficiency
- High surge capacity, High current capability

Maximum Ratings

- Operating Junction Temperature: -55°C to +175°C
- Storage Temperature: -55°C to +175°C
- Typical Thermal Resistance per leg 0.8°C/W Junction to Case

MCC Part Number	Maximum Recurrent Peak Reverse Voltage	Maximum RMS Voltage	Maximum DC Blocking Voltage
MBR12020	20V	14V	20V
MBR12030	30V	21V	30V
MBR12035	35V	24.5V	35V
MBR12040	40V	28V	40V
MBR12045	45V	31.5V	45V
MBR12060	60V	42V	60V
MBR12080	80V	56V	80V
MBR120100	100V	70V	100V

HALF PACK



Electrical Characteristics @ 25°C Unless Otherwise Specified

Average Forward Current	$I_{F(AV)}$	120 A	$T_C = 136^\circ\text{C}$
Peak Forward Surge Current	I_{FSM}	2000A	8.3ms, half sine
Maximum Instantaneous Forward Voltage MBR12020-12045 MBR12060 MBR12080-120100	V_F	.63 V .75 V .84 V	$I_{FM} = 120.0\text{A};$ $T_J = 25^\circ\text{C}$
Maximum DC Reverse Current At Rated DC Blocking Voltage	I_R	4mA 75mA	$T_J = 25^\circ\text{C}$ $T_J = 125^\circ\text{C}$
Typical Junction Capacitance MBR12020-12045 MBR12060 MBR12080-120100	C_J	4600pF 4300pF 3000pF	Measured at 1.0MHz, $V_R=5.0\text{V}$

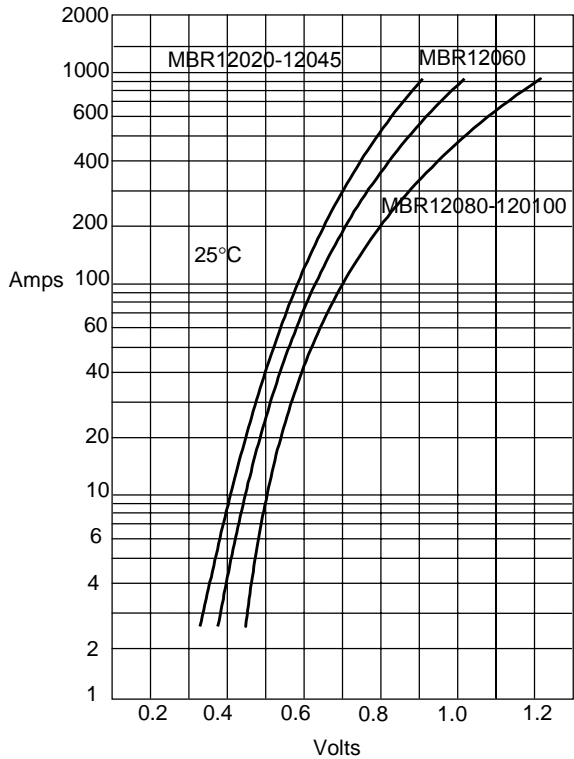
DIM	INCHES		MM		NOTE
	MIN	MAX	MIN	MAX	
A	1.515	1.560	38.48	39.62	
B	.725	.775	18.42	19.69	
C	.595	.625	15.11	15.88	
D	1.182	1.192	30.02	30.28	
E	.745	.755	18.92	19.18	
F	.152	.160	3.86	4.06	∅
G	1/4 - 20		UNC - 2B		
H	.540	.580	13.72	14.73	
J	.15	.160	3.96	4.06	
K	.495	.505	12.57	12.83	∅
L	.120	.130	3.05	3.30	

*Pulse Test: Pulse Width 300µsec, Duty Cycle 2%

MBR12020 thru MBR120100

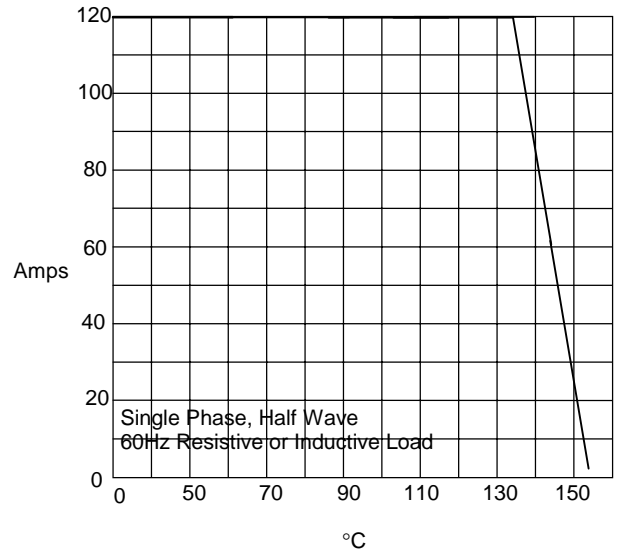


Figure 1
Typical Forward Characteristics



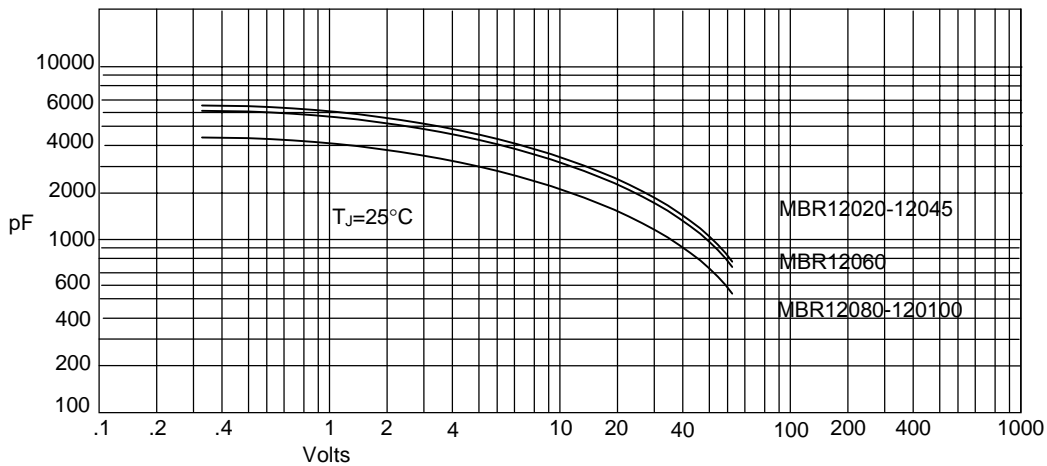
Instantaneous Forward Current - Amperes versus
Instantaneous Forward Voltage - Volts

Figure 2
Forward Derating Curve



Average Forward Rectified Current - Amperes versus
Ambient Temperature - °C

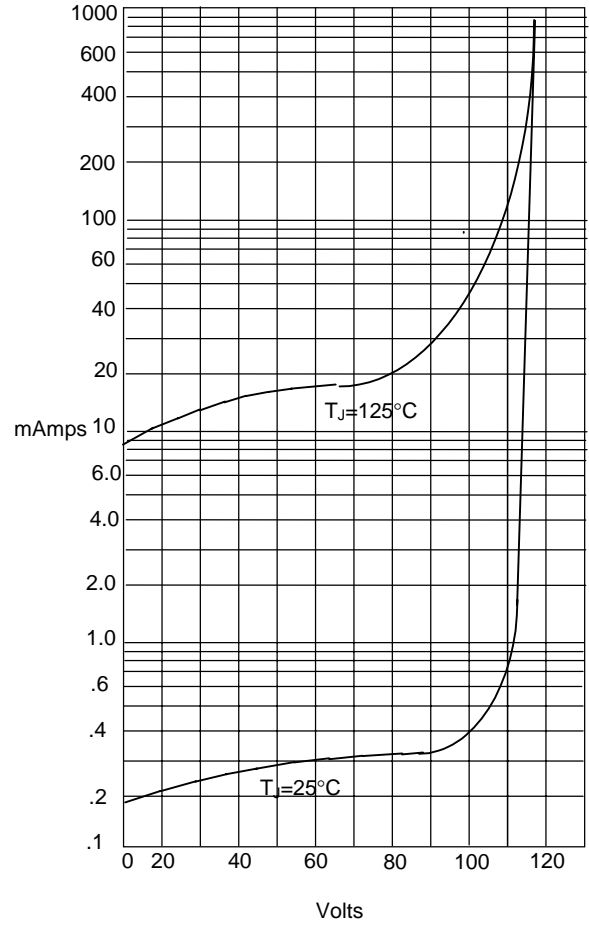
Figure 3
Junction Capacitance



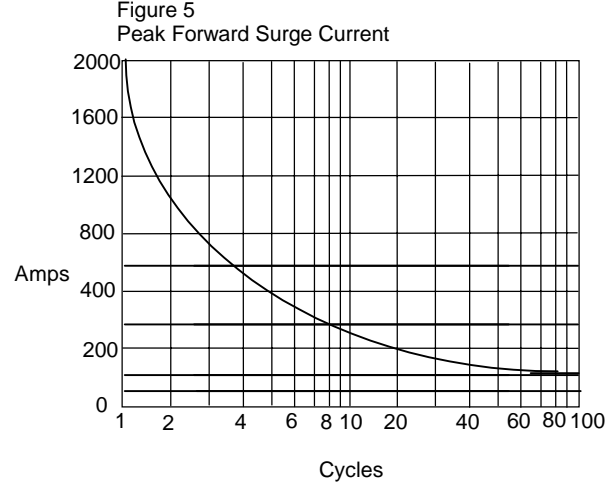
Junction Capacitance - pF versus
Reverse Voltage - Volts



Figure 4
Typical Reverse Characteristics



Instantaneous Reverse Leakage Current - MicroAmperes versus
Percent Of Rated Peak Reverse Voltage - Volts



Peak Forward Surge Current - Amperes versus
Number Of Cycles At 60Hz - Cycles