

- N-Channel Application-Specific MOSFETs
- Ideal for CPU Core DC-DC Converters
- Low Conduction Losses
- Low Switching Losses
- Minimizes Parallel MOSFETs for high current applications
- 100% R_{θ} Tested
- Lead-Free

Description

This new device employs advanced HEXFET Power MOSFET technology to achieve an unprecedented balance of on-resistance and gate charge. The reduced conduction and switching losses make it ideal for high efficiency DC-DC converters that power the latest generation of microprocessors.

The IRLR8103V has been optimized for all parameters that are critical in synchronous buck converters including $R_{DS(on)}$, gate charge and Cdv/dt -induced turn-on immunity. The IRLR8103V offers an extremely low combination of Q_{sw} & $R_{DS(on)}$ for reduced losses in both control and synchronous FET applications.

The package is designed for vapor phase, infra-red, convection, or wave soldering techniques. Power dissipation of greater than 2W is possible in a typical PCB mount application.

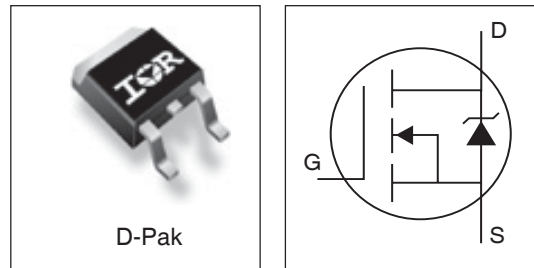

DEVICE CHARACTERISTICS ⑤

	IRLR8103V
$R_{DS(on)}$	7.9 mΩ
Q_G	27 nC
Q_{sw}	12 nC
Q_{oss}	29nC

Absolute Maximum Ratings

Parameter		Symbol	IRLR8103V	Units
Drain-Source Voltage		V_{DS}	30	V
Gate-Source Voltage		V_{GS}	±20	
Continuous Drain or Source Current ($V_{GS} > 10V$)	TC = 25°C	I_D	91	A
	TC = 90°C		63	
Pulsed Drain Current ①		I_{DM}	363	
Power Dissipation ③	TC = 25°C	P_D	115	W
	TC = 90°C		60	
Junction & Storage Temperature Range		T_J, T_{STG}	-55 to 150	°C
Continuous Source Current (Body Diode)		I_S	91	A
Pulsed Source Current ①		I_{SM}	363	

Thermal Resistance

Parameter	Symbol	Typ.	Max.	Units
Maximum Junction-to-Ambient ③⑥	$R_{\theta JA}$	—	50	°C/W
Maximum Junction-to-Case ⑥	$R_{\theta JC}$	—	1.09	

Electrical Characteristics

Parameter	Symbol	Min	Typ	Max	Units	Conditions
Drain-to-Source Breakdown Voltage	BV_{DSS}	30	—	—	V	$V_{GS} = 0V, I_D = 250\mu A$
Static Drain-Source On-Resistance	$R_{DS(on)}$	—	6.9	9.0	m Ω	$V_{GS} = 10V, I_D = 15A$ ②
		—	7.9	10.5		$V_{GS} = 4.5V, I_D = 15A$ ②
Gate Threshold Voltage	$V_{GS(th)}$	1.0	—	3.0	V	$V_{DS} = V_{GS}, I_D = 250\mu A$
Drain-to-Source Leakage Current	I_{DSS}	—	—	50	μA	$V_{DS} = 30V, V_{GS} = 0V$
		—	—	20	μA	$V_{DS} = 24V, V_{GS} = 0$
		—	—	100	μA	$V_{DS} = 24V, V_{GS} = 0, T_J = 100^\circ C$
Gate-Source Leakage Current	I_{GSS}	—	—	± 100	nA	$V_{GS} = \pm 20V$
Total Gate Charge, Control FET	Q_G	—	27	—	nC	$V_{GS} = 5V, I_D = 15A, V_{DS} = 16V$
Total Gate Charge, Synch FET	Q_G	—	23	—		$V_{GS} = 5V, V_{DS} < 100mV$
Pre-Vth Gate-Source Charge	Q_{GS1}	—	4.7	—		$V_{DS} = 16V, I_D = 15A$
Post-Vth Gate-Source Charge	Q_{GS2}	—	2.0	—		
Gate to Drain Charge	Q_{GD}	—	9.7	—		
Switch Charge ($Q_{GS2} + Q_{gd}$)	Q_{SW}	—	12	—		
Output Charge	Q_{OSS}	—	29	—		
Gate Resistance	R_G	0.8	—	3.1		Ω
Turn-On Delay Time	$t_{d(on)}$	—	10	—	ns	$V_{DD} = 16V$
Rise Time	t_r	—	9	—		$I_D = 15A$
Turn-Off Delay Time	$t_{d(off)}$	—	24	—		$V_{GS} = 5.0V$
Fall Time	t_f	—	18	—		Clamped Inductive Load
Input Capacitance	C_{iss}	—	2672	—	pF	$V_{GS} = 16V, V_{GS}=0$
Output Capacitance	C_{oss}	—	1064	—		
Reverse Transfer Capacitance	C_{rss}	—	109	—		

Source-Drain Rating & Characteristics

Parameter	Symbol	Min	Typ	Max	Units	Conditions
Diode Forward Voltage	V_{SD}	—	0.9	1.3	V	$I_S = 15A$ ①, $V_{GS} = 0V$
Reverse Recovery Charge ④	Q_{rr}	—	103	—	nC	$di/dt \sim 700A/\mu s$ $V_{DS} = 16V, V_{GS} = 0V, I_F = 15A$
Reverse Recovery Charge (with Parallel Schottky) ④	$Q_{rr(s)}$	—	96	—	nC	$di/dt = 700A/\mu s$, (with 10BQ040) $V_{DS} = 16V, V_{GS} = 0V, I_F = 15A$

Notes:

- ① Repetitive rating; pulse width limited by max. junction temperature.
- ② Pulse width $\leq 400 \mu s$; duty cycle $\leq 2\%$.
- ③ When mounted on 1 inch square copper board, $t < 10$ sec.
- ④ Typ = measured - Q_{OSS}
- ⑤ Typical values of $R_{DS(on)}$ measured at $V_{GS} = 4.5V$, Q_G , Q_{SW} and Q_{OSS} measured at $V_{GS} = 5.0V, I_F = 15A$.

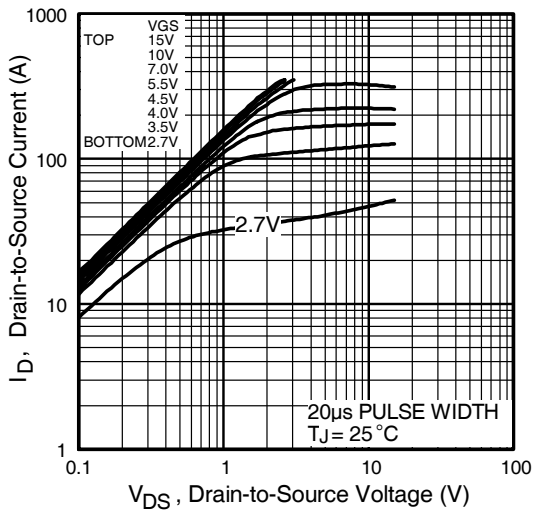

Fig 1. Typical Output Characteristics

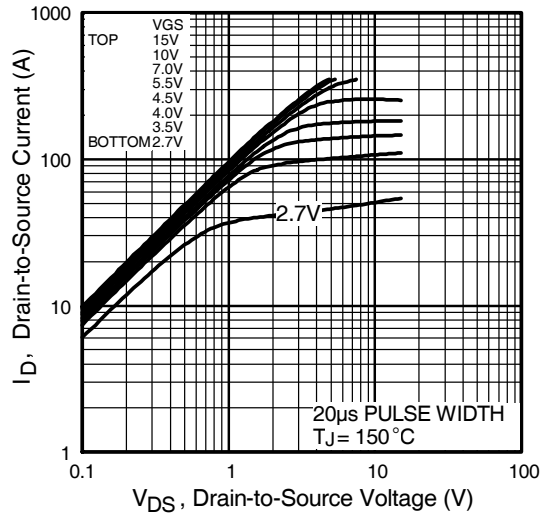

Fig 2. Typical Output Characteristics

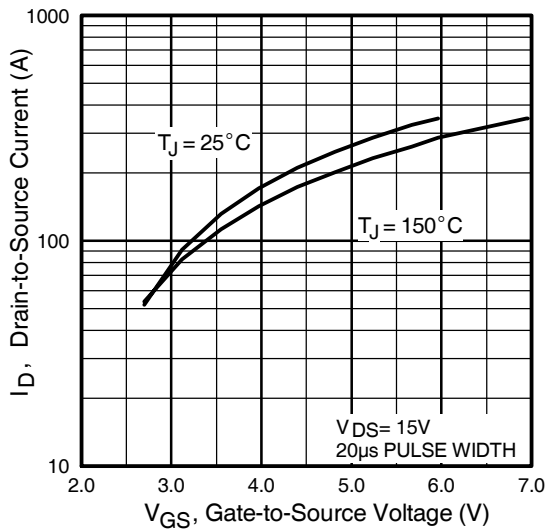

Fig 3. Typical Transfer Characteristics

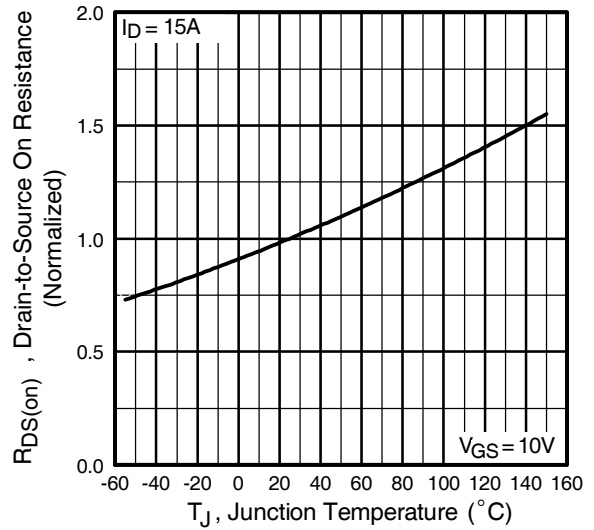

Fig 4. Normalized On-Resistance Vs. Temperature

IRLR8103VPbF

International
IRF Rectifier

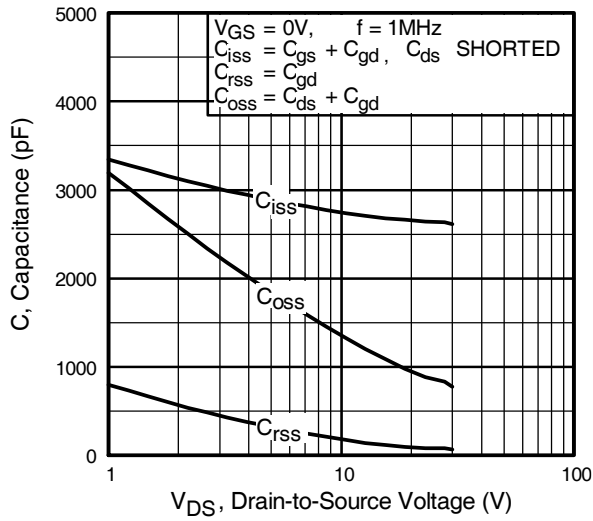

Fig 5. Typical Capacitance Vs. Drain-to-Source Voltage

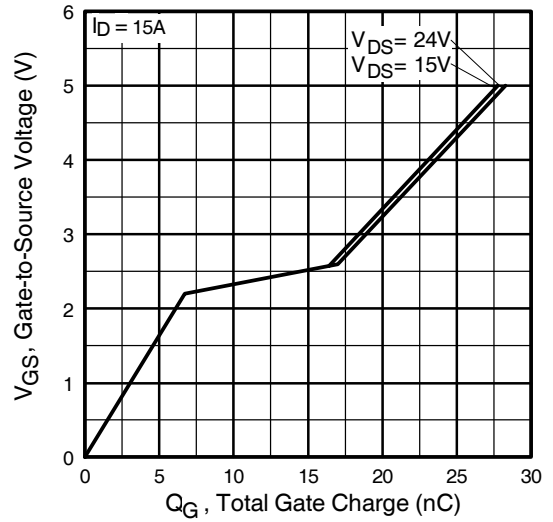

Fig 6. Typical Gate Charge Vs. Gate-to-Source Voltage

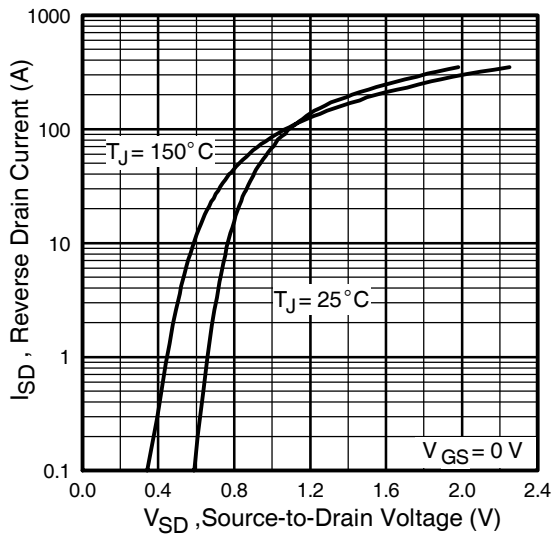

Fig 7. Typical Source-Drain Diode Forward Voltage

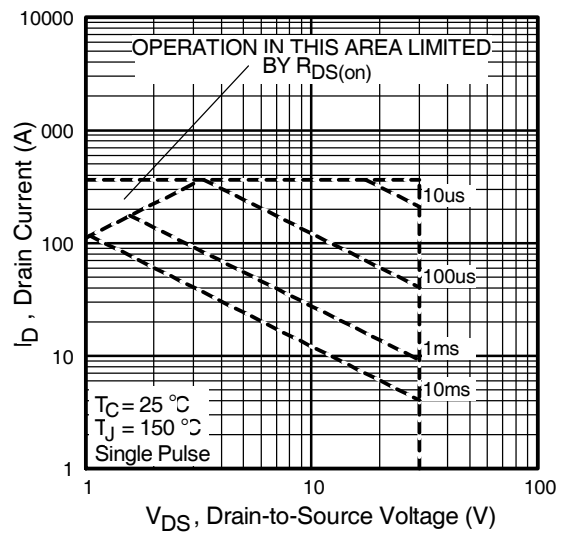

Fig 8. Maximum Safe Operating Area

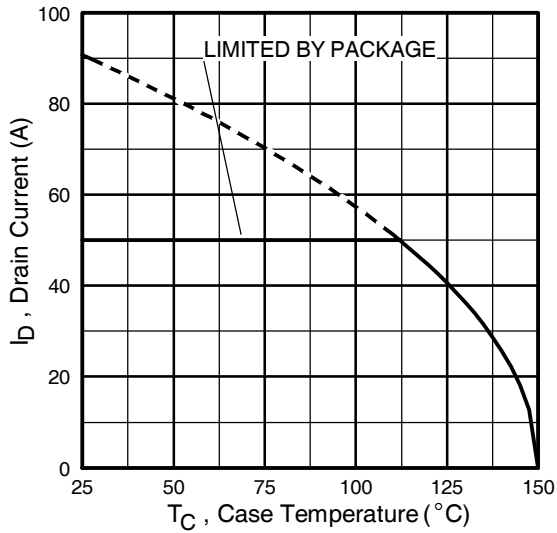

Fig 9. Maximum Drain Current Vs. Case Temperature

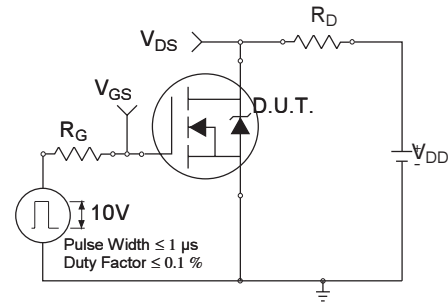

Fig 10a. Switching Time Test Circuit

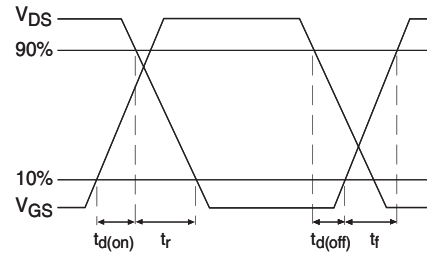

Fig 10b. Switching Time Waveforms

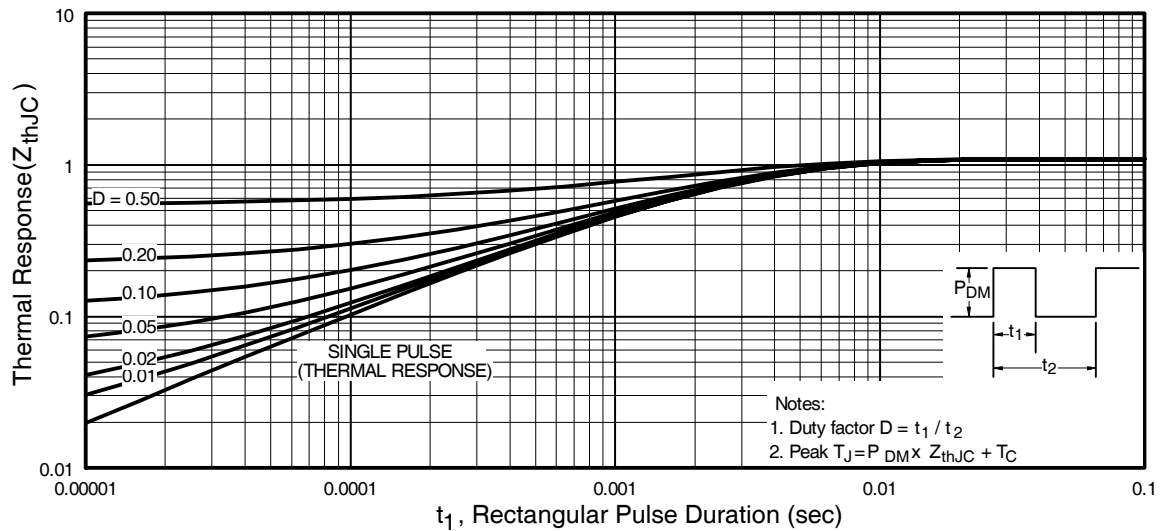

Fig 11. Maximum Effective Transient Thermal Impedance, Junction-to-Case

IRLR8103VPbF

International
IR Rectifier

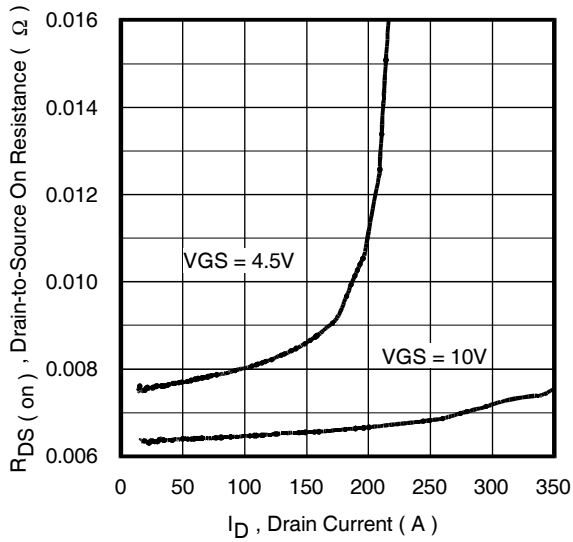

Fig 12. On-Resistance Vs. Drain Current

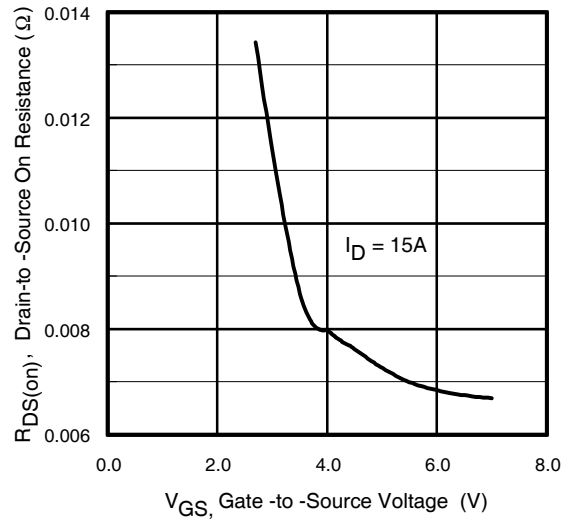

Fig 13. On-Resistance Vs. Gate Voltage

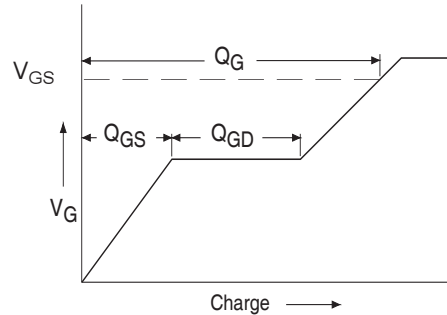
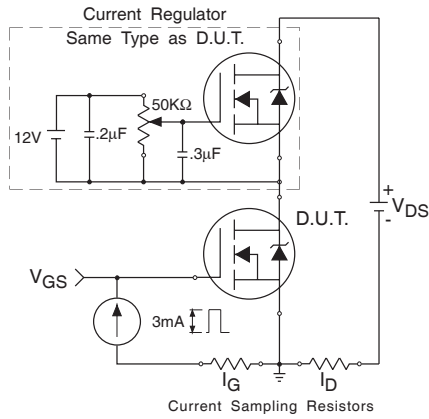
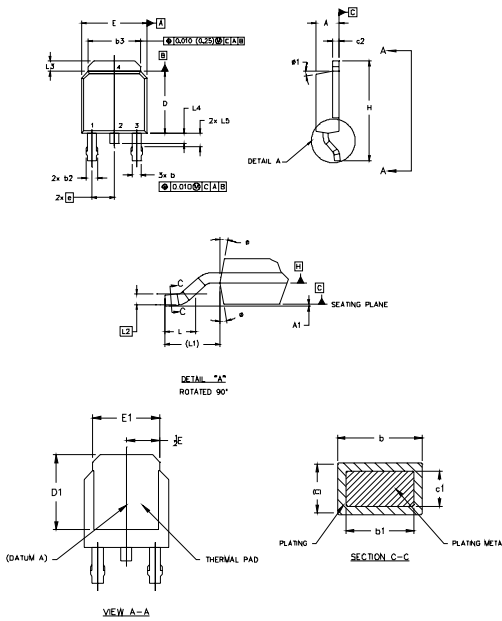

Fig 14a&b. Basic Gate Charge Test Circuit and Waveform

D-Pak (TO-252AA) Package Outline

Dimensions are shown in millimeters (inches)



NOTES:

- 1.0 DIMENSIONING AND TOLERANCING PER ASME Y14.5 M-1994.
- 2.0 DIMENSIONS ARE SHOWN IN INCHES [MILLIMETERS].
- 3.0 LEAD DIMENSION UNCONTROLLED IN L5.
- 4.0 DIMENSION D1 AND E1 ESTABLISH A MINIMUM MOUNTING SURFACE FOR THERMAL PAD.
- 5.0 SECTION C-C DIMENSIONS APPLY TO THE FLAT SECTION OF THE LEAD BETWEEN .005 [0.127] AND .010 [0.254] FROM THE LEAD TIP.
- 6.0 DIMENSION D & E DO NOT INCLUDE MOLD FLASH. MOLD FLASH SHALL NOT EXCEED .005" (0.127) PER SIDE. THESE DIMENSIONS ARE MEASURED AT THE OUTERMOST EXTREMES OF THE PLASTIC BODY.
- 7.0 OUTLINE CONFORMS TO JEDEC OUTLINE TO-252AA.

SYMBOL	MILLIMETERS		INCHES		NOTES
	MIN.	MAX.	MIN.	MAX.	
A	2.18	2.39	.086	.094	
A1		0.13		.005	
b	0.64	0.89	.025	.035	5
b1	0.64	0.79	.025	0.031	6
b2	0.76	1.14	.030	.045	
b3	4.85	5.48	.191	.215	
c	0.48	0.61	.018	.024	5
c1	0.41	0.56	.016	.022	5
D	.046	0.99	.018	.039	5
D1	6.97	8.27	.274	.326	6
D1	5.21	-	.205	-	4
E	6.35	6.73	.250	.265	6
E1	6.32	-	.250	-	4
e		2.39		.090 BSC	
H	6.40	10.41	.252	.410	
L	1.40	1.78	.055	.070	
L1		2.74 REF.		.108 REF.	
L3		0.051 BSC		.002 BSC	
L3	0.89	1.27	.035	.050	
L4		1.02		.040	
L5	1.14	1.52	.045	.060	
#	0"	10"	0"	10"	
#1	0"	10"	0"	10"	

LEAD ASSIGNMENTS

HEXFET

- 1.- GATE
- 2.- DRAIN
- 3.- SOURCE
- 4.- DRAIN

IRFets CoPACK

- 1.- GATE
- 2.- COLLECTOR
- 3.- EMITTER
- 4.- COLLECTOR

D-Pak (TO-252AA) Part Marking Information

EXAMPLE: THIS IS AN IRFR120
WITH ASSEMBLY
LOT CODE 1234
ASSEMBLED ON WW 16, 1999
IN THE ASSEMBLY LINE "A"

Note: "P" in assembly line position
indicates "Lead-Free"

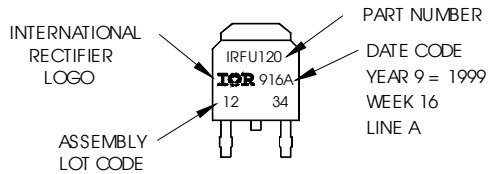

OR

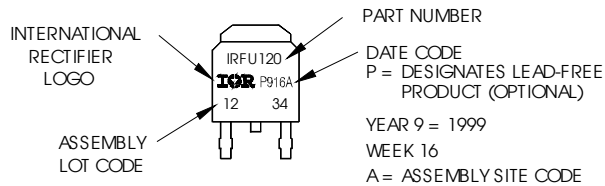

IRLR8103VPbF

International
IOR Rectifier

D-Pak (TO-252AA) Tape & Reel Information

Dimensions are shown in millimeters (inches)

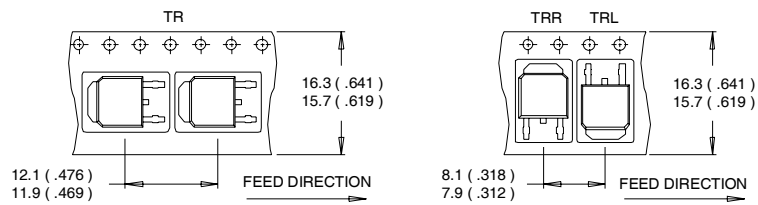

NOTES :

1. CONTROLLING DIMENSION : MILLIMETER.
2. ALL DIMENSIONS ARE SHOWN IN MILLIMETERS (INCHES).
3. OUTLINE CONFORMS TO EIA-481 & EIA-541.

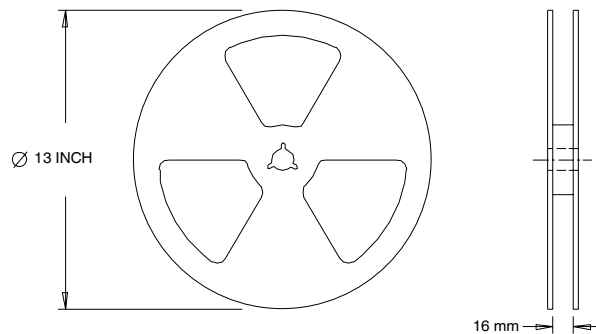

NOTES :

1. OUTLINE CONFORMS TO EIA-481.

Data and specifications subject to change without notice.

International
IOR Rectifier

IR WORLD HEADQUARTERS: 233 Kansas St., El Segundo, California 90245, USA Tel: (310) 252-7105
TAC Fax: (310) 252-7903

Visit us at www.irf.com for sales contact information.12/04

www.irf.com