

74LCX11

Low Voltage Triple 3-Input AND Gate with 5V Tolerant Inputs

General Description

The LCX11 is a triple 3-input AND gate with buffered outputs. LCX devices are designed for low voltage (2.5V or 3.3V) operation with the added capability of interfacing to a 5V signal environment.

The 74LCX11 is fabricated with advanced CMOS technology to achieve high speed operation while maintaining CMOS low power dissipation.

Features

- 5V tolerant inputs and outputs
- 2.3V–3.6V V_{CC} specifications provided
- 6.0ns t_{PD} max ($V_{CC} = 3.3V$), 10 μA I_{CC} max
- Power down high impedance inputs and outputs
- ± 24 mA output drive ($V_{CC} = 3.0V$)
- Implements patented noise/EMI reduction circuitry
- Latch-up performance exceeds 500 mA
- ESD performance:
 - Human body model > 2000V
 - Machine model > 200V

Ordering Code:

Order Number	Package Number	Package Description
74LCX11M	M14A	14-Lead Small Outline Integrated Circuit (SOIC), JEDEC MS-120, 0.150" Narrow
74LCX11SJ	M14D	14-Lead Small Outline Package (SOP), EIAJ TYPE II, 5.3mm Wide
74LCX11MTC	MTC14	14-Lead Thin Shrink Small Outline Package (TSSOP), JEDEC MO-153, 4.4mm Wide

Connection Diagram

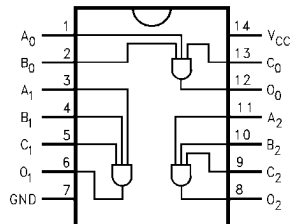

Logic Symbol

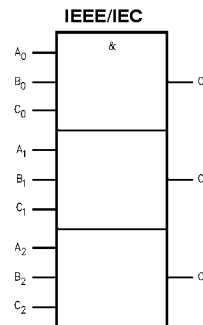

Pin Descriptions

Pin Names	Description
A_n, B_n, C_n	Inputs
O_n	Outputs

Logic Diagram

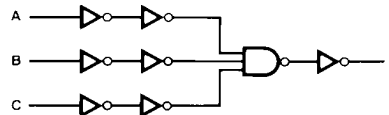

Absolute Maximum Ratings (Note 1)					
Symbol	Parameter	Value	Conditions	Units	
V _{CC}	Supply Voltage	-0.5 to +7.0		V	
V _I	DC Input Voltage	-0.5 to +7.0		V	
V _O	DC Output Voltage	-0.5 to V _{CC} + 0.5	Output in HIGH or LOW State (Note 2)	V	
I _{IK}	DC Input Diode Current	-50	V _I < GND	mA	
I _{OK}	DC Output Diode Current	-50	V _O < GND	mA	
		+50	V _O > V _{CC}	mA	
I _O	DC Output Source/Sink Current	±50		mA	
I _{CC}	DC Supply Current per Supply Pin	±100		mA	
I _{GND}	DC Ground Current per Ground Pin	±100		mA	
T _{STG}	Storage Temperature	-65 to +150		°C	

Recommended Operating Conditions (Note 3)					
Symbol	Parameter	Min	Max	Units	
V _{CC}	Supply Voltage	Operating	2.0	3.6	V
		Data Retention	1.5	3.6	
V _I	Input Voltage	0	5.5	V	
V _O	Output Voltage		HIGH or LOW State	0	V _{CC}
I _{OH} /I _{OL}	Output Current		V _{CC} = 3.0V - 3.6V		±24
			V _{CC} = 2.7V - 3.0V		±12
			V _{CC} = 2.3V - 2.7V		±8
T _A	Free-Air Operating Temperature	-40	85	°C	
Δt/ΔV	Input Edge Rate, V _{IN} = 0.8V-2.0V, V _{CC} = 3.0V	0	10	ns/V	

Note 1: The Absolute Maximum Ratings are those values beyond which the safety of the device cannot be guaranteed. The device should not be operated at these limits. The parametric values defined in the Electrical Characteristics tables are not guaranteed at the Absolute Maximum Ratings. The "Recommended Operating Conditions" table will define the conditions for actual device operation.

Note 2: I_O Absolute Maximum Rating must be observed.

Note 3: Unused inputs must be held HIGH or LOW. They may not float.

DC Electrical Characteristics

Symbol	Parameter	Conditions	V _{CC} (V)	T _A = -40°C to -85°C		Units
				Min	Max	
V _{IH}	HIGH Level Input Voltage		2.3 - 2.7	1.7		V
			2.7 - 3.6	2.0		
V _{IL}	LOW Level Input Voltage		2.3 - 2.7		0.7	V
			2.7 - 3.6		0.8	
V _{OH}	HIGH Level Output Voltage	I _{OH} = -100 μA	2.3 - 3.6	V _{CC} - 0.2		V
		I _{OH} = -8 mA	2.3	1.8		
		I _{OH} = -12 mA	2.7	2.2		
		I _{OH} = -18 mA	3.0	2.4		
		I _{OH} = -24 mA	3.0	2.2		
V _{OL}	LOW Level Output Voltage	I _{OL} = 100 μA	2.3 - 3.6		0.2	V
		I _{OL} = 8 mA	2.3		0.6	
		I _{OL} = 12 mA	2.7		0.4	
		I _{OL} = 16 mA	3.0		0.4	
		I _{OL} = 24 mA	3.0		0.55	
I _I	Input Leakage Current	0 ≤ V _I ≤ 5.5V	2.3 - 3.6		±5.0	μA
I _{OFF}	Power-Off Leakage Current	V _I or V _O = 5.5V	0		10	μA
I _{CC}	Quiescent Supply Current	V _I = V _{CC} or GND	2.3 - 3.6		10	μA
		3.6V ≤ V _I ≤ 5.5V	2.3 - 3.6		±10	
ΔI _{CC}	Increase in I _{CC} per Input	V _{IH} = V _{CC} - 0.6V	2.3 - 3.6		500	μA

AC Electrical Characteristics								
Symbol	Parameter	$T_A = -40^{\circ}\text{C to } +85^{\circ}\text{C}, R_L = 500 \Omega$						Units
		$V_{CC} = 3.3V \pm 0.3V$		$V_{CC} = 2.7V$		$V_{CC} = 2.5V \pm 0.2V$		
		$C_L = 50 \text{ pF}$		$C_L = 50 \text{ pF}$		$C_L = 30 \text{ pF}$		
		Min	Max	Min	Max	Min	Max	
t_{PLH}	Propagation Delay	1.5	6.0	1.5	7.0	1.5	7.2	ns
t_{PHL}		1.5	6.0	1.5	7.0	1.5	7.2	
t_{OSLH}	Output to Output Skew (Note 4)		1.0					ns
t_{OSHL}			1.0					

Note 4: Skew is defined as the absolute value of the difference between the actual propagation delay for any two separate outputs of the same device. The specification applies to any outputs switching in the same direction, either HIGH-to-LOW (t_{OSHL}) or LOW-to-HIGH (t_{OSLH}).

Dynamic Switching Characteristics					
Symbol	Parameter	Conditions	V_{CC} (V)	$T_A = 25^{\circ}\text{C}$	Units
				Typical	
V_{OLP}	Quiet Output Dynamic Peak V_{OL}	$C_L = 50 \text{ pF}, V_{IH} = 3.3V, V_{IL} = 0V$ $C_L = 30 \text{ pF}, V_{IH} = 2.5V, V_{IL} = 0V$	3.3	0.8	V
			2.5	0.6	
V_{OLV}	Quiet Output Dynamic Peak V_{OL}	$C_L = 50 \text{ pF}, V_{IH} = 3.3V, V_{IL} = 0V$ $C_L = 30 \text{ pF}, V_{IH} = 2.5V, V_{IL} = 0V$	3.3	-0.8	V
			2.5	-0.6	

Capacitance				
Symbol	Parameter	Conditions	Typical	Units
C_{IN}	Input Capacitance	$V_{CC} = \text{Open}, V_I = 0V \text{ or } V_{CC}$	7	pF
C_{OUT}	Output Capacitance	$V_{CC} = 3.3V, V_I = 0V \text{ or } V_{CC}$	8	pF
C_{PD}	Power Dissipation Capacitance	$V_{CC} = 3.3V, V_I = 0V \text{ or } V_{CC}, f = 10 \text{ MHz}$	25	pF

AC Loading and Waveforms Generic for LCX Family

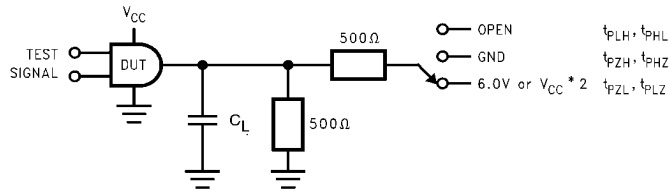
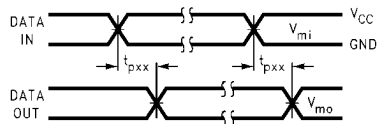
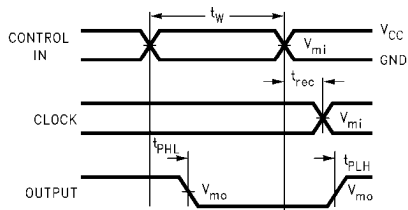

FIGURE 1. AC Test Circuit
(C_L includes probe and jig capacitance)

Test	Switch
t_{PLH}, t_{PHL}	Open
t_{PZH}, t_{PHZ}	6V at $V_{CC} = 3.3 \pm 0.3V$ $V_{CC} \times 2$ at $V_{CC} = 2.5 \pm 0.2V$
t_{PZH}, t_{PHZ}	GND



Waveform for Inverting and Non-Inverting Functions



Propagation Delay, Pulse Width and t_{rec} Waveforms

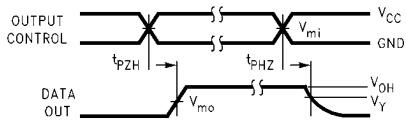

3-STATE Output High Enable and Disable Times for Logic

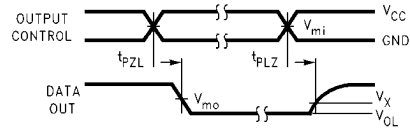

3-STATE Output Low Enable and Disable Times for Logic

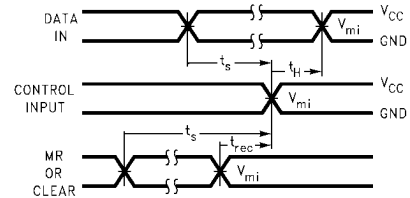

Setup Time, Hold Time and Recovery Time for Logic

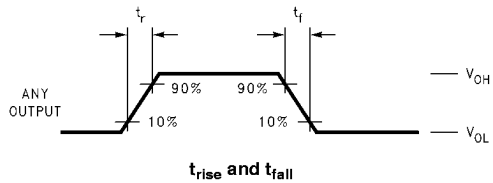
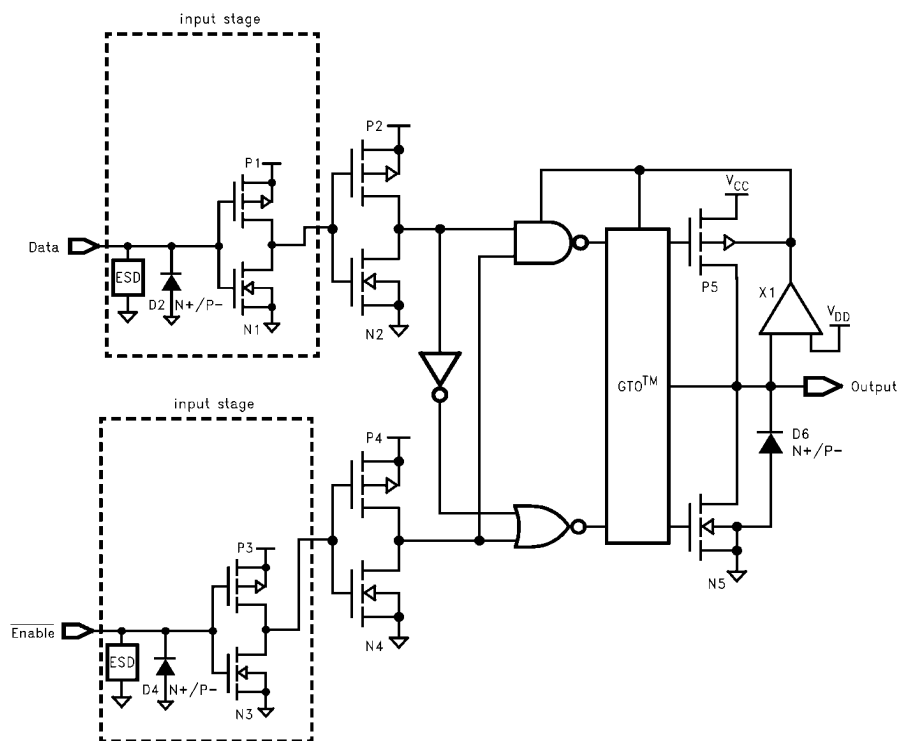

FIGURE 2. Waveforms
(Input Pulse Characteristics; $f=1MHz, t_r=t_f=3ns$)

Symbol	V_{CC}		
	$3.3V \pm 0.3V$	$2.7V$	$2.5V \pm 0.2V$
V_{mi}	1.5V	1.5V	$V_{CC}/2$
V_{mo}	1.5V	1.5V	$V_{CC}/2$
V_x	$V_{OL} + 0.3V$	$V_{OL} + 0.3V$	$V_{OL} + 0.15V$
V_y	$V_{OH} - 0.3V$	$V_{OH} - 0.3V$	$V_{OH} - 0.15V$

Schematic Diagram Generic for LCX Family

74LCX11



Physical Dimensions inches (millimeters) unless otherwise noted

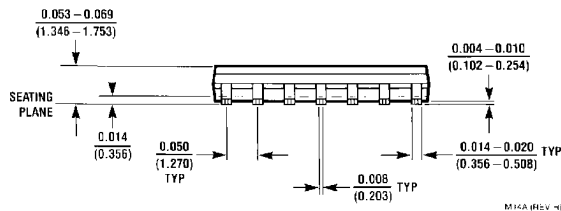
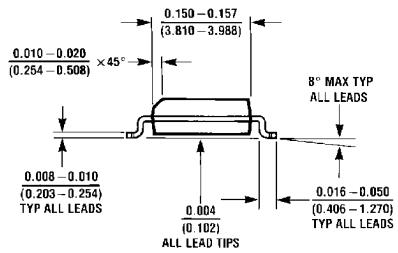
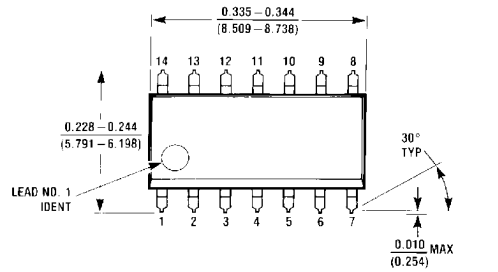

**14-Lead Small Outline Integrated Circuit (SOIC), JEDEC MS-120, 0.150" Narrow
Package Number M14A**

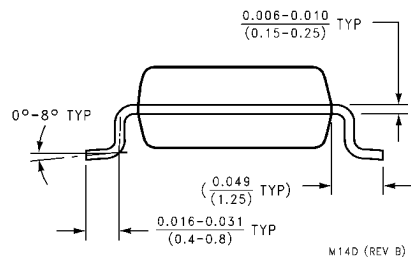
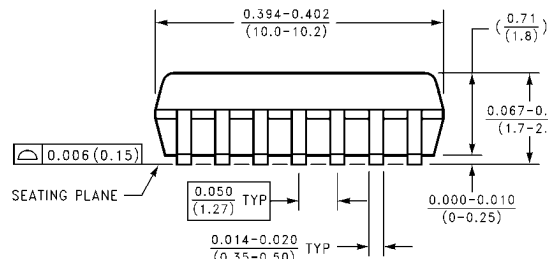
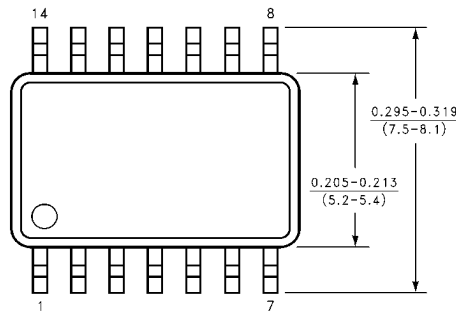

**14-Lead Small Outline Package (SOP), EIAJ TYPE II, 5.3mm Wide
Package Number M14D**

Physical Dimensions inches (millimeters) unless otherwise noted (Continued)

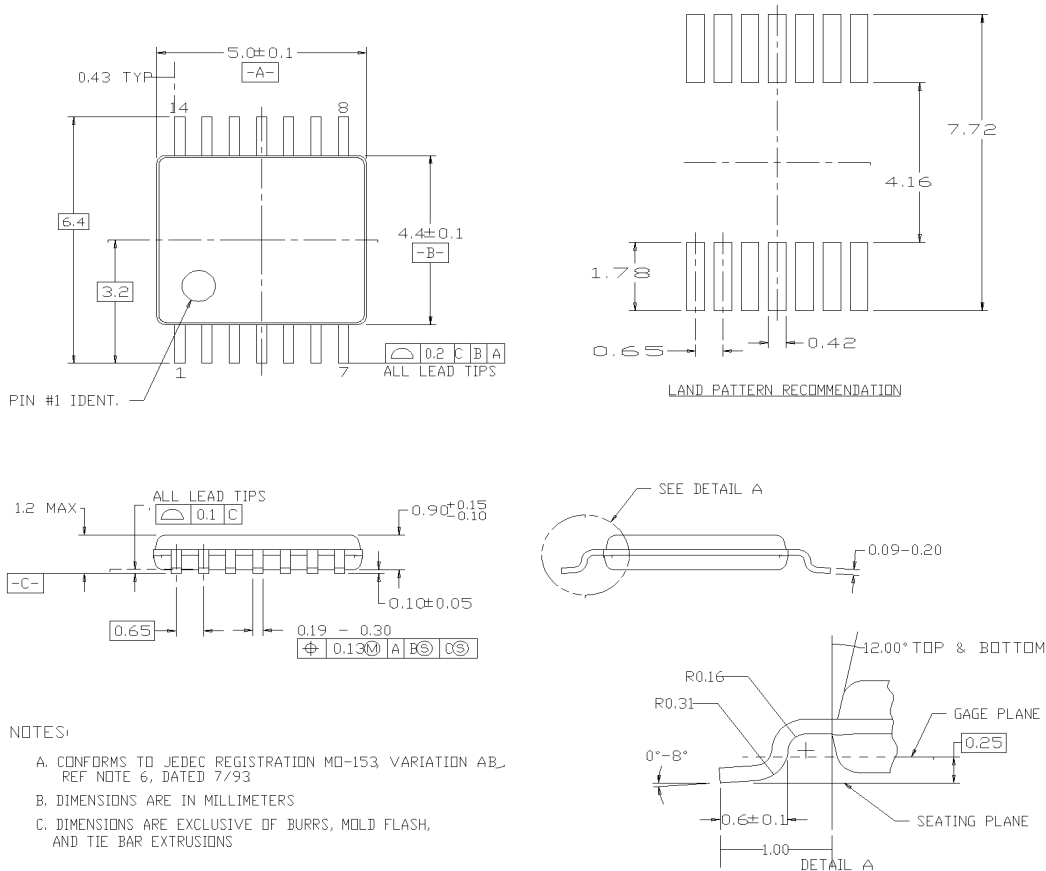

**14-Lead Thin Shrink Small Outline Package (TSSOP), JEDEC MO-153, 4.4mm Wide
Package Number MTC14**

LIFE SUPPORT POLICY

FAIRCHILD'S PRODUCTS ARE NOT AUTHORIZED FOR USE AS CRITICAL COMPONENTS IN LIFE SUPPORT DEVICES OR SYSTEMS WITHOUT THE EXPRESS WRITTEN APPROVAL OF THE PRESIDENT OF FAIRCHILD SEMICONDUCTOR CORPORATION. As used herein:

1. Life support devices or systems are devices or systems which, (a) are intended for surgical implant into the body, or (b) support or sustain life, and (c) whose failure to perform when properly used in accordance with instructions for use provided in the labeling, can be reasonably expected to result in a significant injury to the user.
2. A critical component in any component of a life support device or system whose failure to perform can be reasonably expected to cause the failure of the life support device or system, or to affect its safety or effectiveness.

www.fairchildsemi.com

Fairchild does not assume any responsibility for use of any circuitry described, no circuit patent licenses are implied and Fairchild reserves the right at any time without notice to change said circuitry and specifications.