

Feedthru Filters – W2F4/W3F4 Series

EMI Filtering, Broadband Filtering, LCD Filtering

GENERAL DESCRIPTION

Available in a 4-Element 0508 and 0612 Feedthru Array package, AVX's line of Feedthrus is an ideal choice for EMI suppression, broadband I/O filtering, LCD filtering and V_{CC} power line conditioning. The unique construction of the Feedthru capacitor provides low parallel inductance and offers excellent decoupling capability for all high di/dt environments and provides significant noise reduction in digital circuits up to 5 GHz. A range of filtering characteristics is available. The Feedthru Array contains four elements with a common ground connection, making it an ideal choice for multi-line designs. Additional benefits of the multi-element array package are reduced placement costs, reduced component counts and PCB space savings. Feedthru filters can be used to meet IEC, MIL-STD-461E, FCC, and SAE radiated and conducted emission requirements.

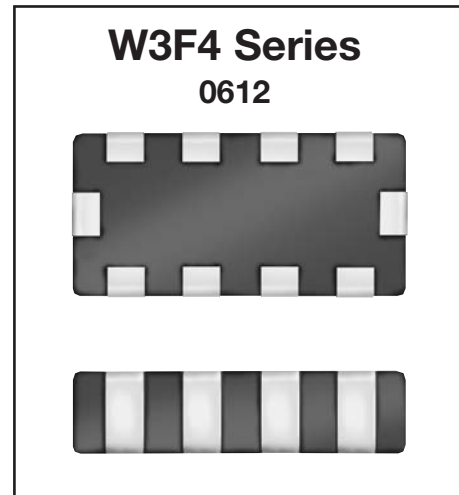

FREQUENCY CHARACTERISTICS

Part Number	Roll Off Frequency	Center Frequency	10 db Point	20 db Range	
W3F41A2208AT	270 MHz	2640 MHz	970 MHz	1780 MHz	3500 MHz
W3F41A4708AT	65 MHz	2000 MHz	185 MHz	600 MHz	3400 MHz
W3F41A1018AT	65 MHz	2030 MHz	185 MHz	560 MHz	3500 MHz
W3F45C2218AT	35 MHz	1885 MHz	120 MHz	470 MHz	3300 MHz
W3F45C4718AT	20 MHz	1860 MHz	60 MHz	220 MHz	3500 MHz
W2F43A2208AT	208 MHz	4750 MHz	616 MHz	1407 MHz	7300 MHz
W2F43A4708AT	110 MHz	2750 MHz	330 MHz	900 MHz	4600 MHz
W2F43A1018AT	60 MHz	1300 MHz	179 MHz	501 MHz	7200 MHz

CAPACITOR VALUES & PERFORMANCE CHARACTERISTICS

Part Number	Typical Capacitance	Insulation Resistance	Temperature Characteristics
W3F41A2208AT	22pF	> 1000 M _Ω	NP0
W3F41A4708AT	47pF	> 1000 M _Ω	NP0
W3F41A1018AT	100pF	> 1000 M _Ω	NP0
W3F45C2218AT	220pF	> 1000 M _Ω	X7R
W3F45C4718AT	470pF	> 1000 M _Ω	X7R
W2F43A2208AT	22pF	> 1000 M _Ω	NP0
W2F43A4708AT	47pF	> 1000 M _Ω	NP0
W2F43A1018AT	100pF	> 1000 M _Ω	NP0

CASE SIZE & VOLTAGE RATINGS

Part Number	Case Size	Current Rating	DC Resistance	Voltage Rating
W3F41A2208AT W3F41A4708AT W3F41A1018AT	0612	300 mA	< 0.6 _Ω	100 V
W3F45C2218AT W3F45C4718AT	0612	300 mA	< 0.6 _Ω	50 V
W2F43A2208AT W2F43A4708AT W2F43A1018AT	0508	50 mA	< 3.0 _Ω	25 V

W3F41A2208AT S_{21} Curves

Preliminary

AVX W3F41A2208AT Typical S_{21}

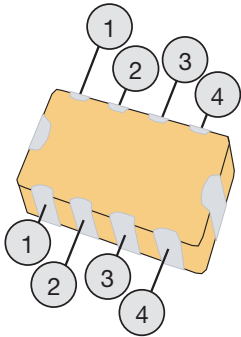
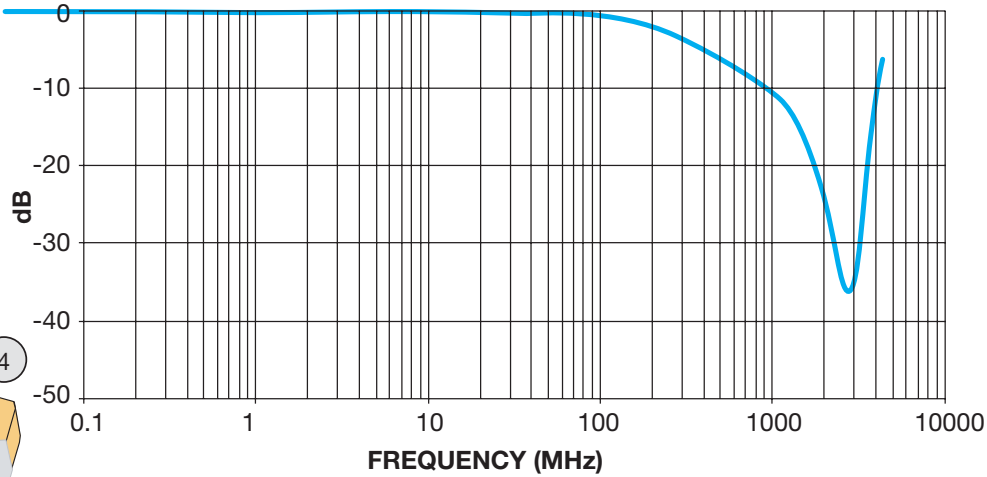

Far Side Crosstalk

Preliminary
AVX W3F41A2208AT
Typical Far-side XTALK
Elements 1 - 2

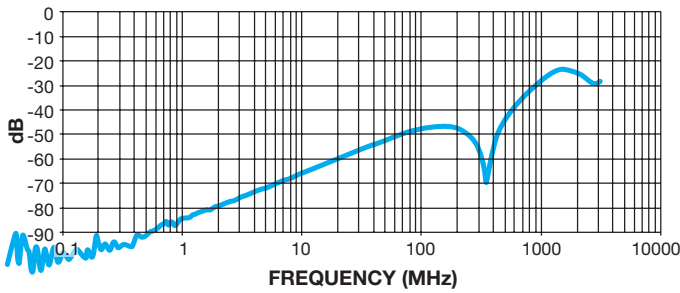

Preliminary
AVX W3F41A2208AT
Typical Far-side XTALK
Elements 1 - 3

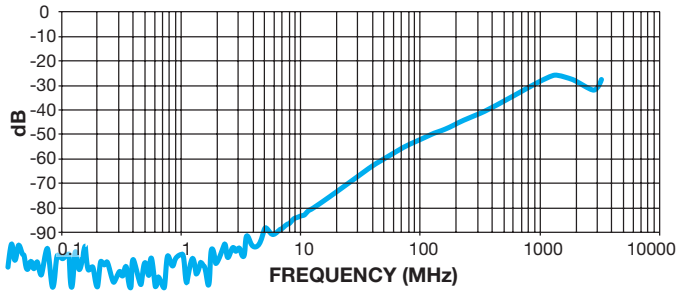

Preliminary
AVX W3F41A2208AT
Typical Far-side XTALK
Elements 1 - 4

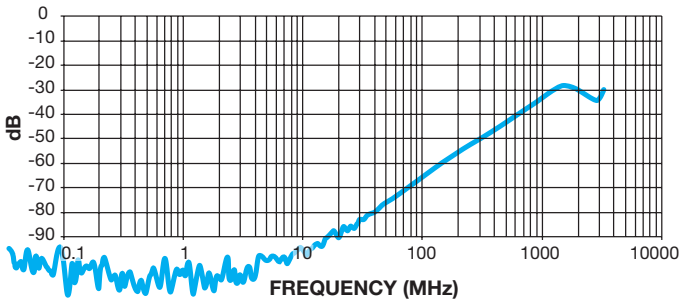

Preliminary
AVX W3F41A2208AT
Typical Far-side XTALK
Elements 2 - 3

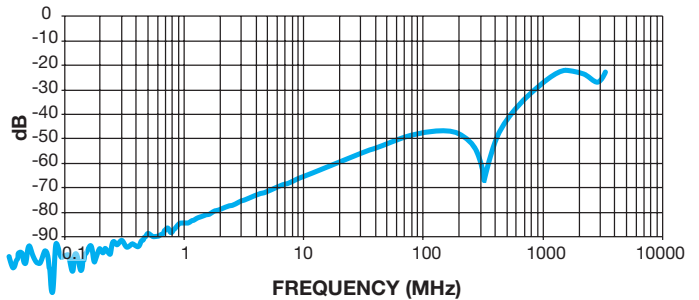

W3F41A4708AT S_{21} Curves

Preliminary

AVX W3F41A4708AT Typical S_{21}

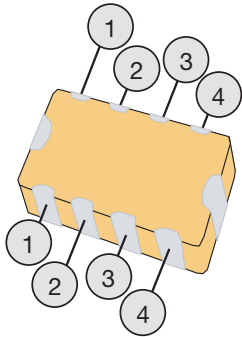
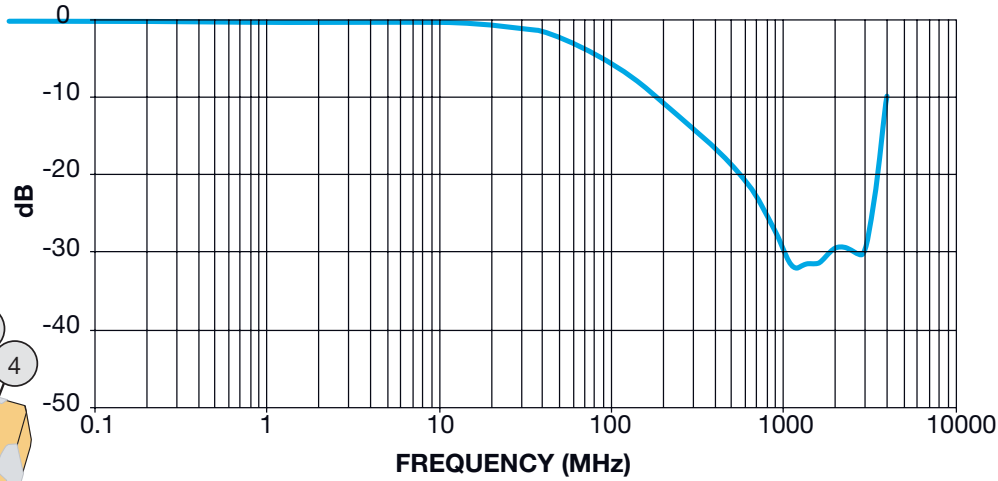

Far Side Crosstalk

Preliminary
AVX W3F41A4708AT
Typical Far-side XTALK
Elements 1 - 2

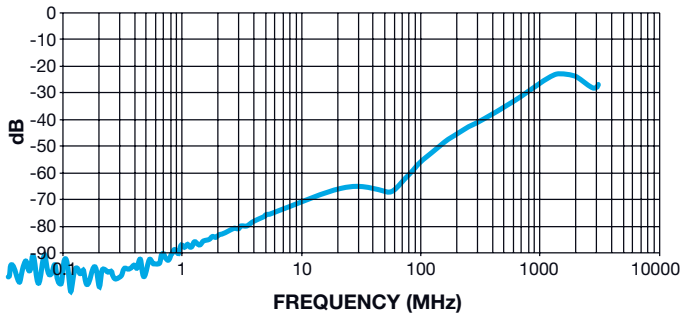

Preliminary
AVX W3F41A4708AT
Typical Far-side XTALK
Elements 1 - 3

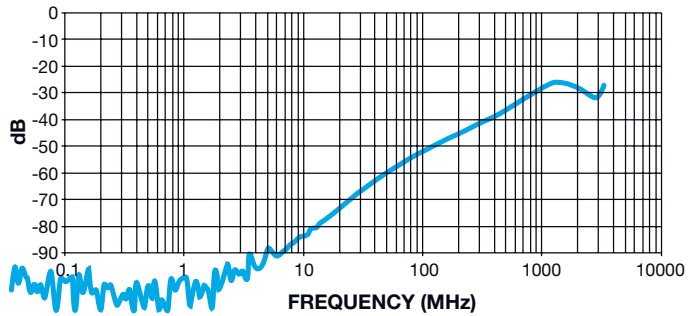

Preliminary
AVX W3F41A4708AT
Typical Far-side XTALK
Elements 1 - 4

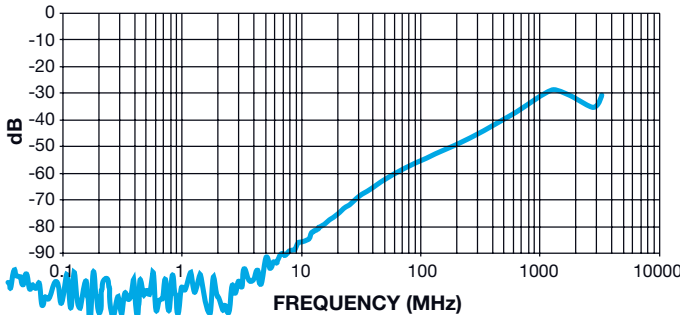

Preliminary
AVX W3F41A4708AT
Typical Far-side XTALK
Elements 2 - 3

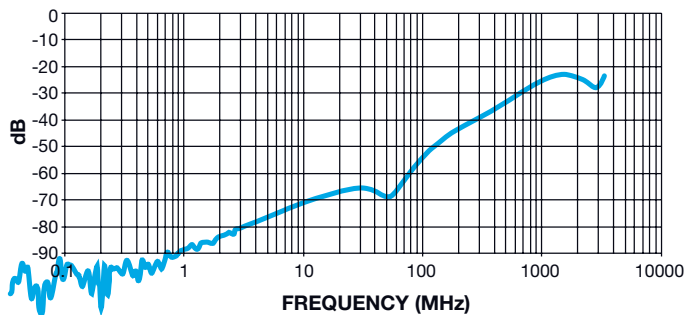

W3F41A1018AT S_{21} Curves

Preliminary

AVX W2F41A1018AT Typical S_{21}

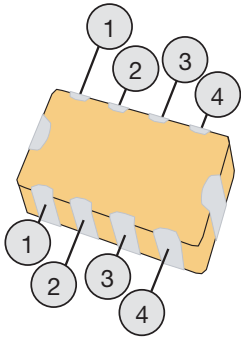
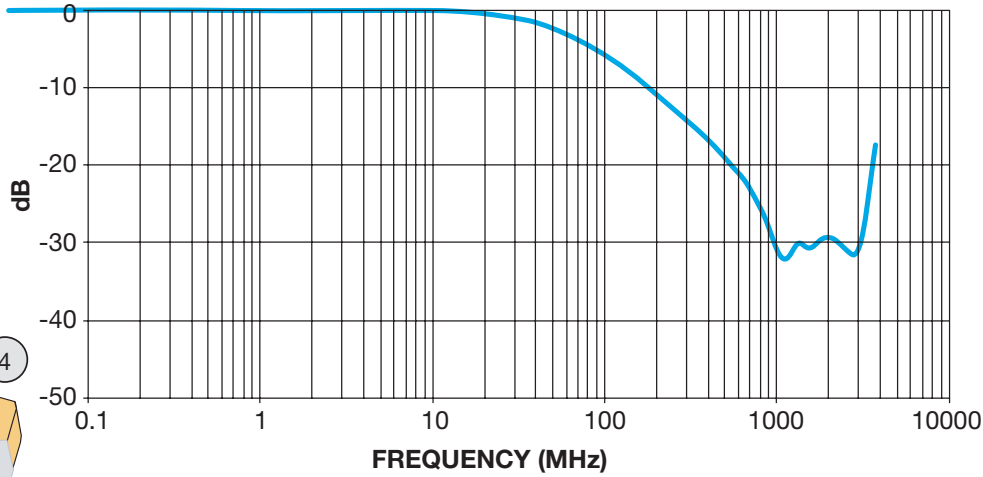

Far Side Crosstalk

Preliminary
AVX W3F41A1018AT
Typical Far-side XTALK
Elements 1 - 2

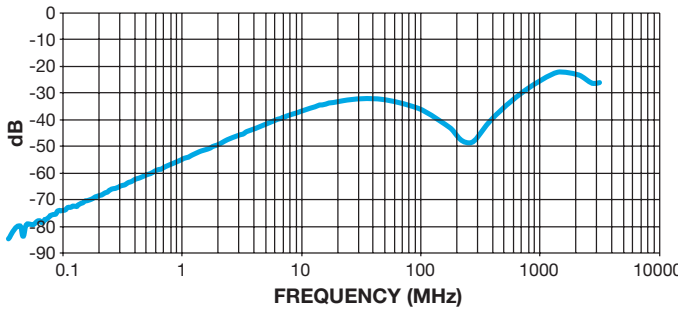

Preliminary
AVX W3F41A1018AT
Typical Far-side XTALK
Elements 1 - 3

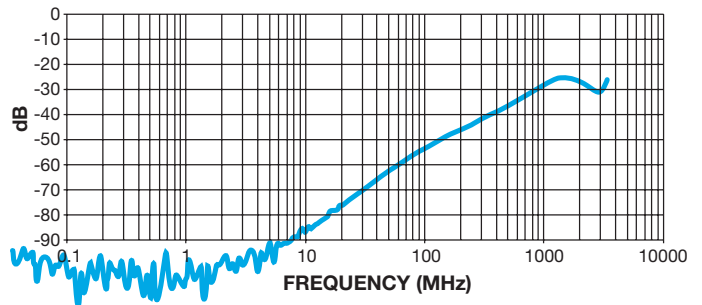

Preliminary
AVX W3F41A1018AT
Typical Far-side XTALK
Elements 1 - 4

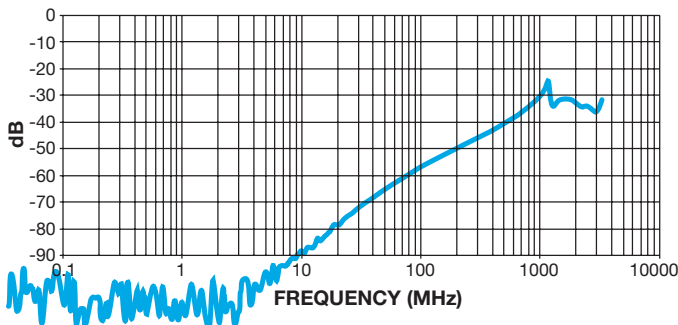

Preliminary
AVX W3F41A1018AT
Typical Far-side XTALK
Elements 2 - 3

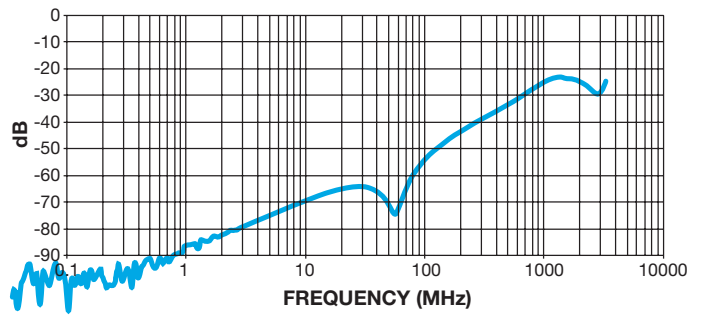

W3F45C2218AT S_{21} Curves

Preliminary

AVX W3F45C2218AT Typical S_{21}

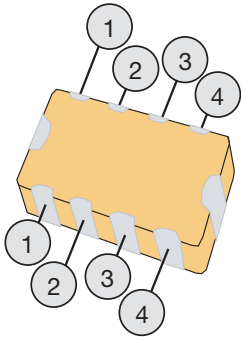
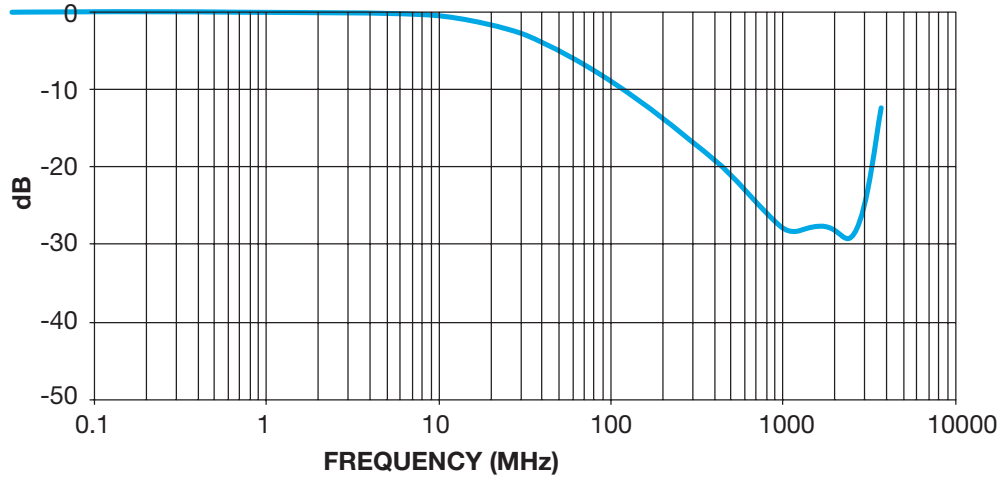

Far Side Crosstalk

Preliminary
AVX W3F45C2218AT
Typical Far-side XTALK
Elements 1 - 2

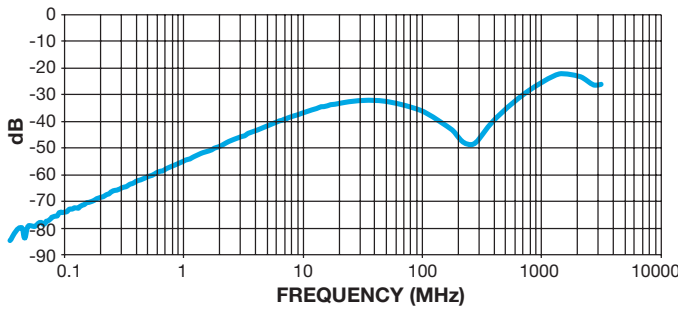

Preliminary
AVX W3F45C2218AT
Typical Far-side XTALK
Elements 1 - 3

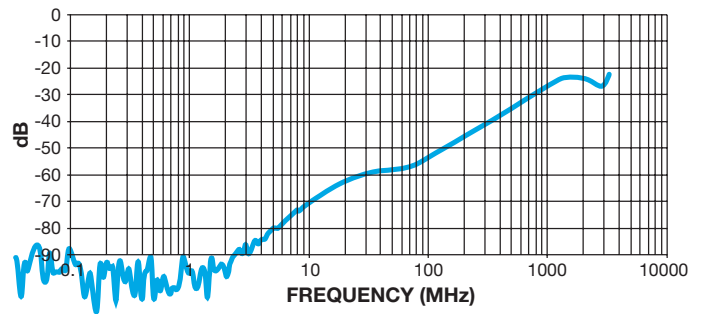

Preliminary
AVX W3F45C2218AT
Typical Far-side XTALK
Elements 1 - 4

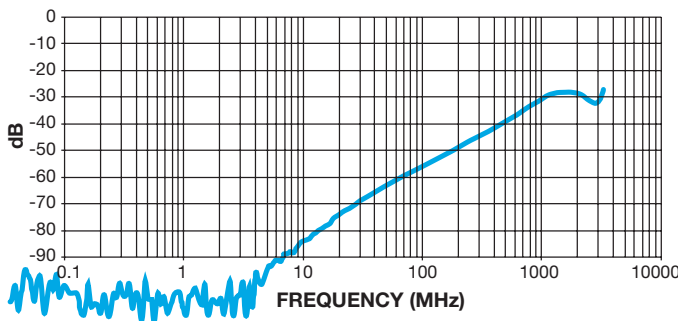

Preliminary
AVX W3F45C2218AT
Typical Far-side XTALK
Elements 2 - 3

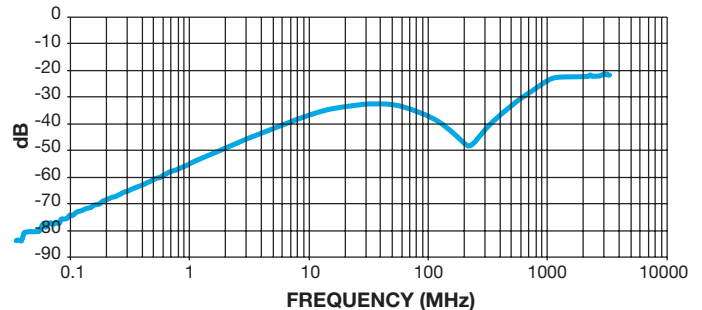

W3F45C4718AT S_{21} Curves

Preliminary

AVX W3F45C4718AT Typical S_{21}

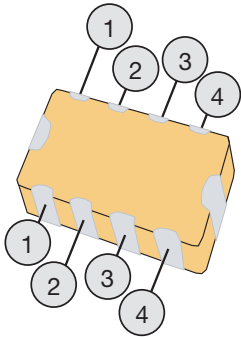
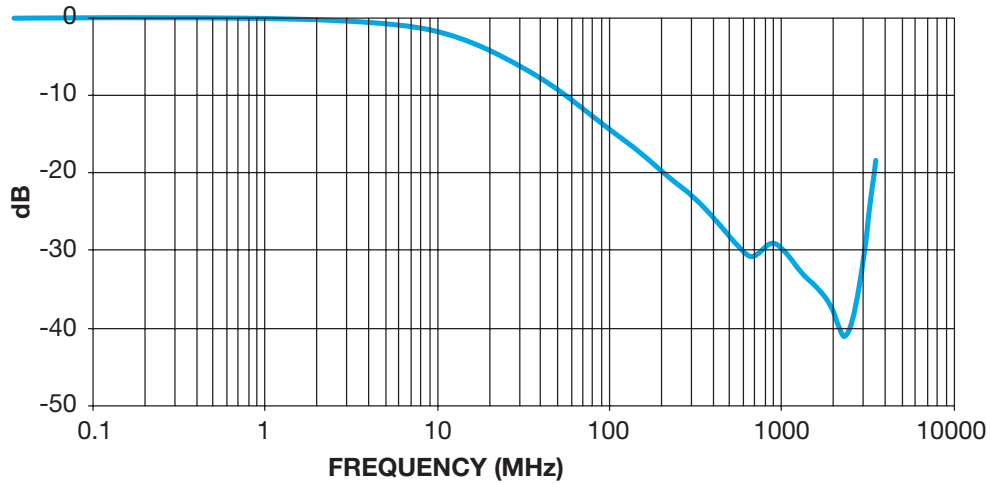

Far Side Crosstalk

Preliminary
AVX W3F45C4718AT
Typical Far-side XTALK
Elements 1 - 2

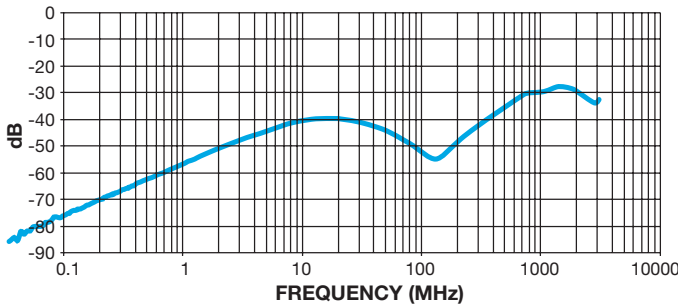

Preliminary
AVX W3F45C4718AT
Typical Far-side XTALK
Elements 1 - 3

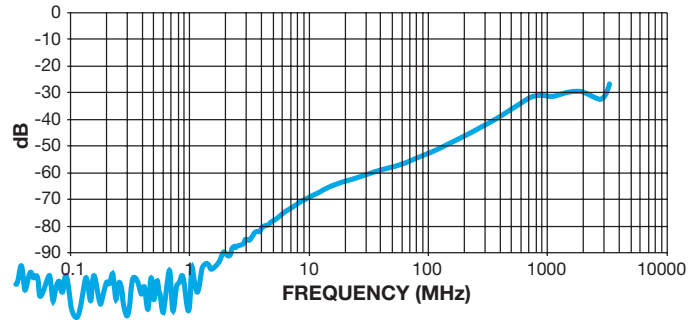

Preliminary
AVX W3F45C4718AT
Typical Far-side XTALK
Elements 1 - 4

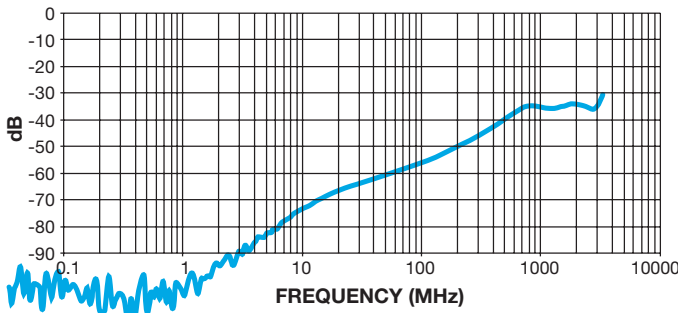

Preliminary
AVX W3F45C4718AT
Typical Far-side XTALK
Elements 2 - 3

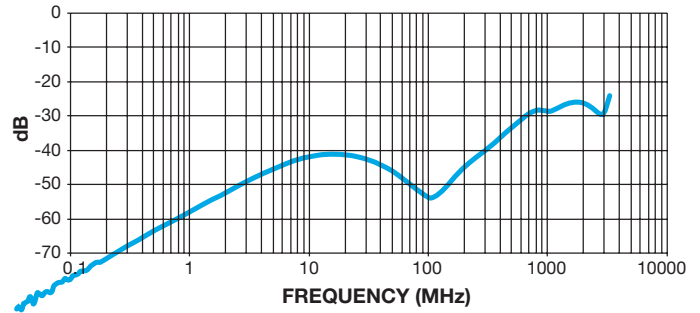

W2F43A2208AT S_{21} Curves

Preliminary

AVX W2F43A2208AT Typical S_{21}

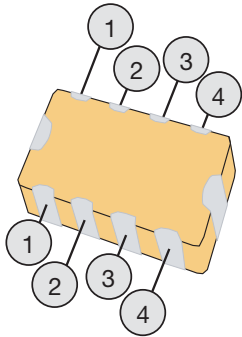
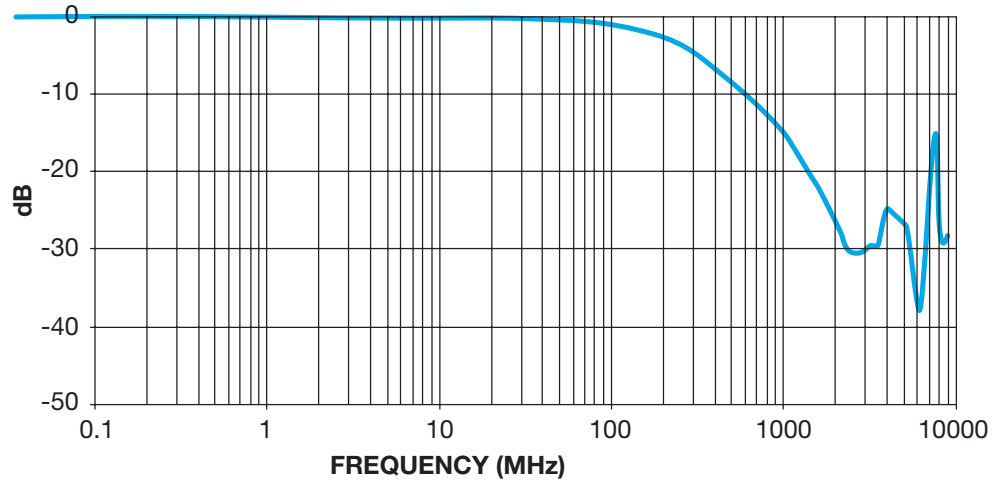

Far Side Crosstalk

Preliminary
AVX W2F43A2208AT
Typical Far-side XTALK
Elements 1 - 2

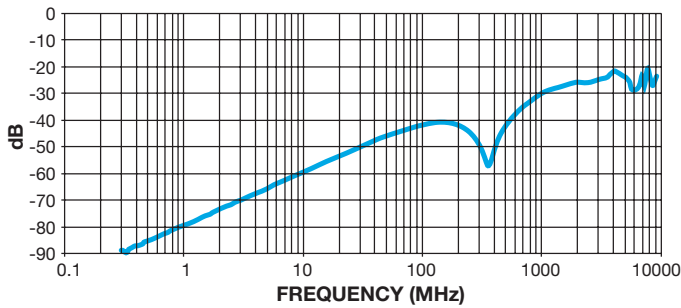

Preliminary
AVX W2F43A2208AT
Typical Far-side XTALK
Elements 1 - 3

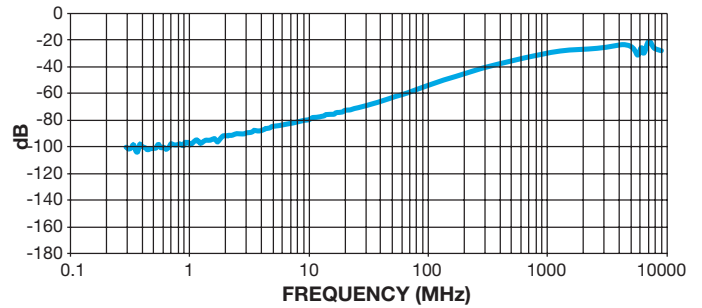

Preliminary
AVX W2F43A2208AT
Typical Far-side XTALK
Elements 1 - 4

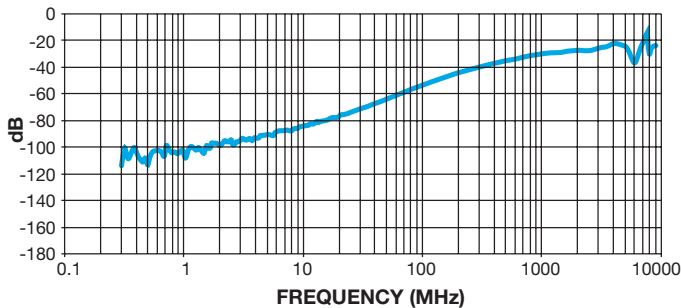

Preliminary
AVX W2F43A2208AT
Typical Far-side XTALK
Elements 2 - 3

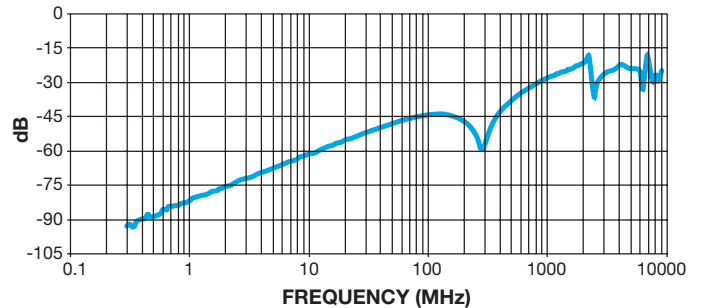

W2F43A4708AT S_{21} Curves

Preliminary

AVX W2F43A4708AT Typical S_{21}

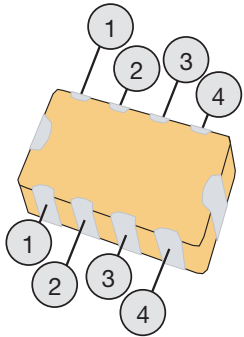
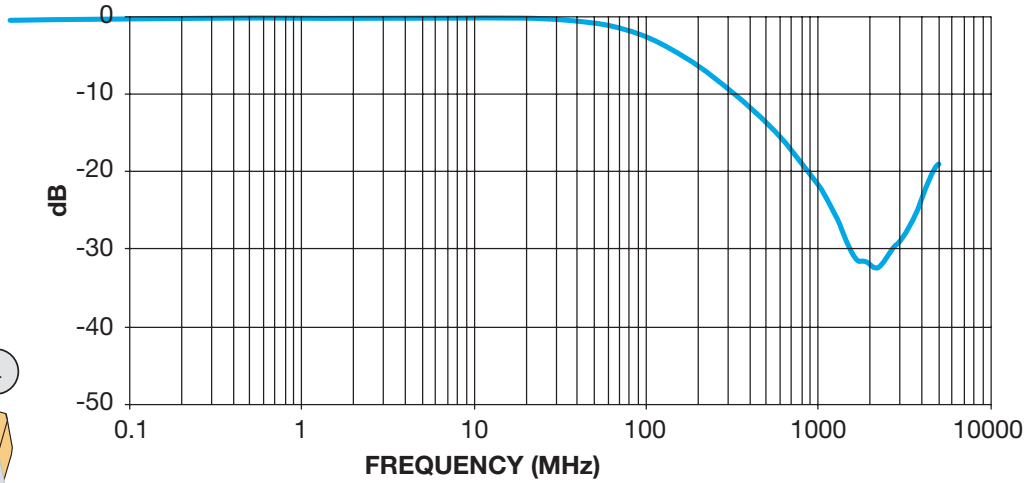

Far Side Crosstalk

Preliminary
AVX W2F43A4708AT
Typical Far-side XTALK
Elements 1 - 2

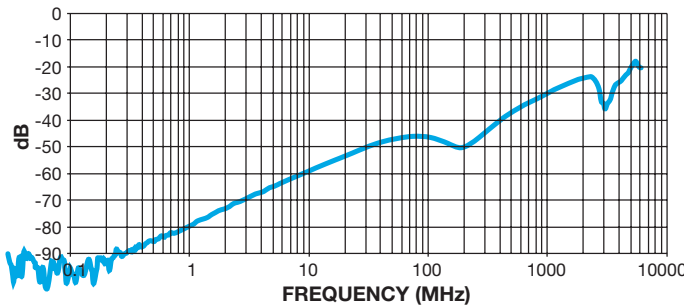

Preliminary
AVX W2F43A4708AT
Typical Far-side XTALK
Elements 1 - 3

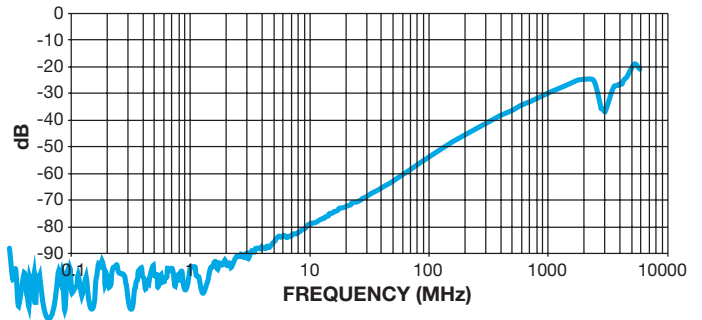

Preliminary
AVX W2F43A4708AT
Typical Far-side XTALK
Elements 1 - 4

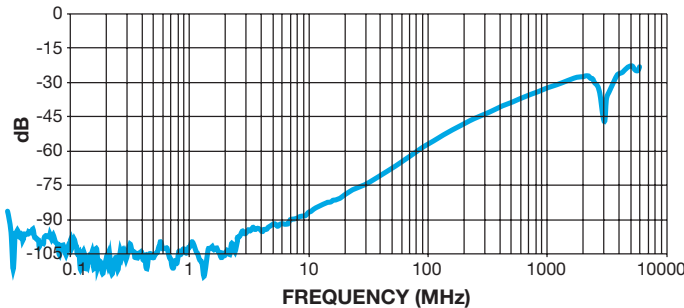

Preliminary
AVX W2F43A4708AT
Typical Far-side XTALK
Elements 2 - 3

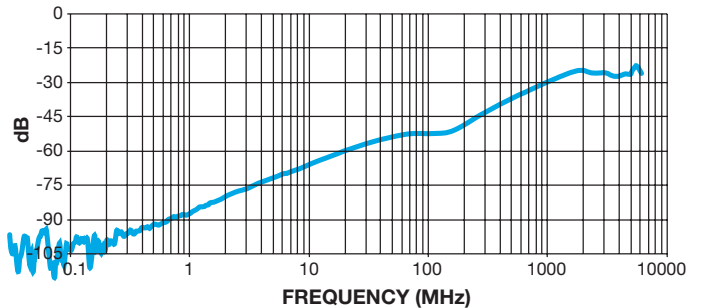

W2F43A1018AT S_{21} Curves

Preliminary

AVX W2F43A1018AT Typical S_{21}

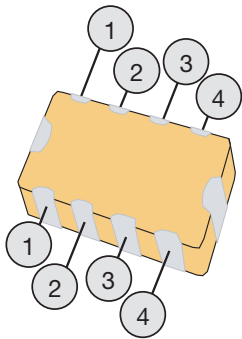
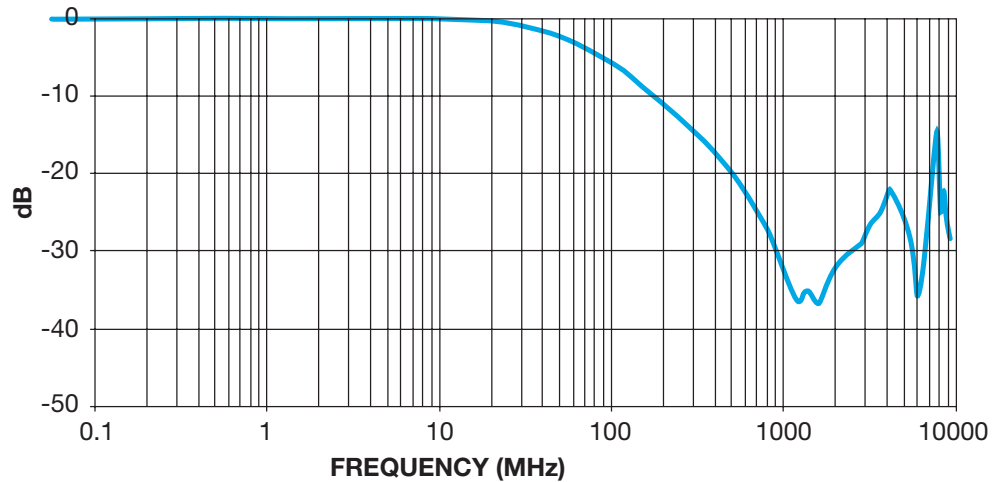

Far Side Crosstalk

Preliminary
AVX W2F43A1018AT
Typical Far-side XTALK
Elements 1 - 2

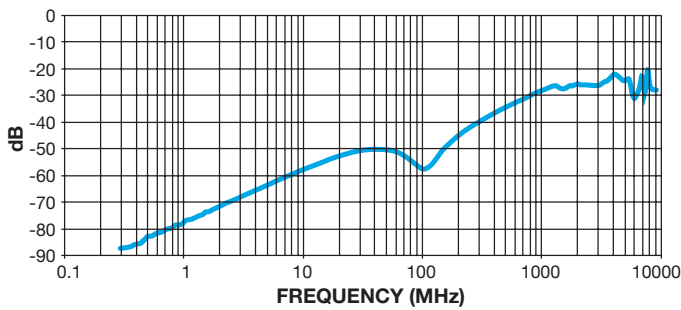

Preliminary
AVX W2F43A1018AT
Typical Far-side XTALK
Elements 1 - 3

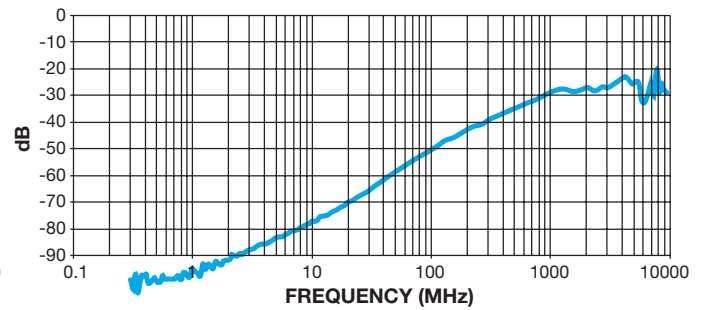

Preliminary
AVX W2F43A1018AT
Typical Far-side XTALK
Elements 1 - 4

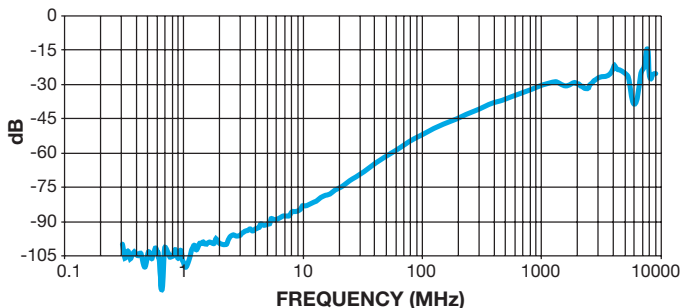

Preliminary
AVX W2F43A1018AT
Typical Far-side XTALK
Elements 2 - 3

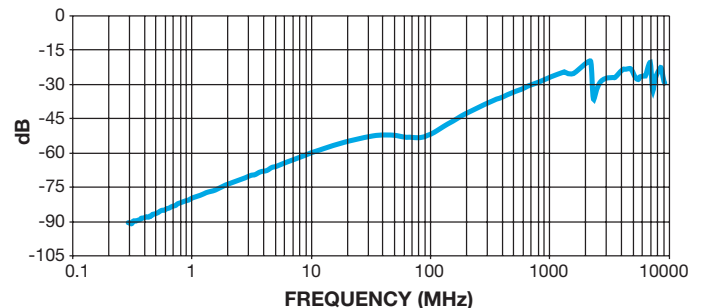

Feedthru Filters — W2F4 / W3F4 Series



EMI Filtering, Broadband Filtering, LCD Filtering

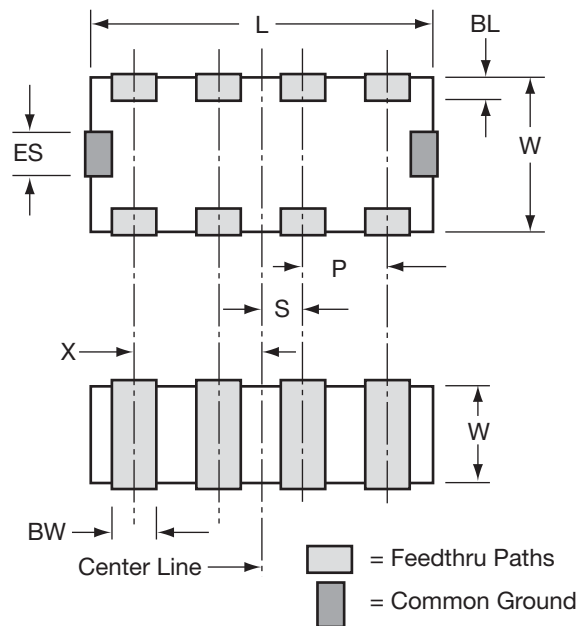

DIMENSIONS

millimeters (inches)

L	W	T	BW	BL	P	X	S	ES
3.25±0.15 (0.128±0.006)	1.60±0.20 (0.063±0.008)	1.22 max (0.048 max)	0.41±0.10 (0.016±0.004)	0.18 (0.007 ^{+0.25} / _{-0.06})	0.76 REF. (0.030 REF.)	1.14±0.10 (0.045±0.004)	0.38±0.10 (0.015±0.004)	0.41±0.10 (0.016±0.004)
2.10±0.15 (0.083±0.006)	1.30±0.20 (0.051±0.006)	1.02 max (0.040 max)	0.25±0.10 (0.010±0.004)	0.18 (0.007 ^{+0.25} / _{-0.08})	0.50 REF. (0.020 REF.)	0.75±0.10 (0.030±0.004)	0.25±0.10 (0.010±0.004)	0.25±0.10 (0.010±0.004)

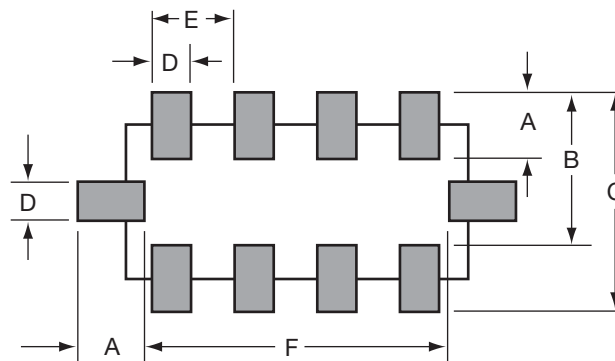

PAD LAYOUT DIMENSIONS

millimeters (inches)

CASE SIZE	A	B	C	D	E	F
0612	0.6 (0.024)	1.6 (0.064)	2.2 (0.088)	0.35 (0.014)	0.76 (0.030)	2.6 (0.104)
0508	0.56 (0.022)	1.32 (0.052)	1.88 (0.074)	0.25 (0.010)	0.50 (0.020)	1.80 (0.071)