

TRANSISTOR (PNP)

BC807-16W

BC807-25W

BC807-40W

FEATURES

- Ideally suited for automatic insertion
- epitaxial planar die construction
- complementary NPN type available(BC817)

MARKING: 807-16:5A; 807-25:5B; 807-40:5C

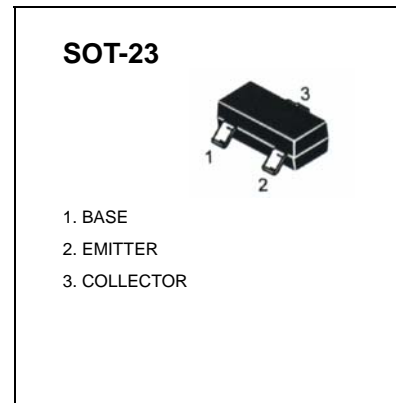

MAXIMUM RATINGS (T_A=25°C unless otherwise noted)

Symbol	Parameter	Value	Units
V _{CBO}	Collector-Base Voltage	-50	V
V _{CEO}	Collector-Emitter Voltage	-45	V
V _{EBO}	Emitter-Base Voltage	-5	V
I _C	Collector Current -Continuous	-0.5	A
P _C	Collector Power Dissipation	0.3	W
T _j	Junction Temperature	150	°C
T _{stg}	Storage Temperature	-55-150	°C

ELECTRICAL CHARACTERISTICS (T_{amb}=25°C unless otherwise specified)

Parameter	Symbol	Test conditions	MIN	MAX	UNIT
Collector-base breakdown voltage	V _{CBO}	I _C = -10 μ A, I _E =0	-50		V
Collector-emitter breakdown voltage	V _{CEO}	I _C = -10mA, I _B =0	-45		V
Emitter-base breakdown voltage	V _{EBO}	I _E = -1 μ A, I _C =0	-5		V
Collector cut-off current	I _{CBO}	V _{CB} = -45V, I _E =0		-0.1	μ A
Collector cut-off current	I _{CEO}	V _{CE} = -40V, I _B =0		-0.2	μ A
Emitter cut-off current	I _{EBO}	V _{EB} = -4 V, I _C =0		-0.1	μ A
DC current gain	807-16 807-25 807-40	h _{FE(1)} V _{CE} = -1V, I _C = -100mA	100 160 250	250 400 600	
Collector-emitter saturation voltage	V _{CE(sat)}	I _C =-500mA, I _B = -50mA		-0.7	V
Base-emitter saturation voltage	V _{BE(sat)}	I _C = -500mA, I _B = -50mA		-1.2	V
Transition frequency	f _T	V _{CE} = -5V, I _C = -10mA f=100MHz	100		MHz

Typical Characteristics

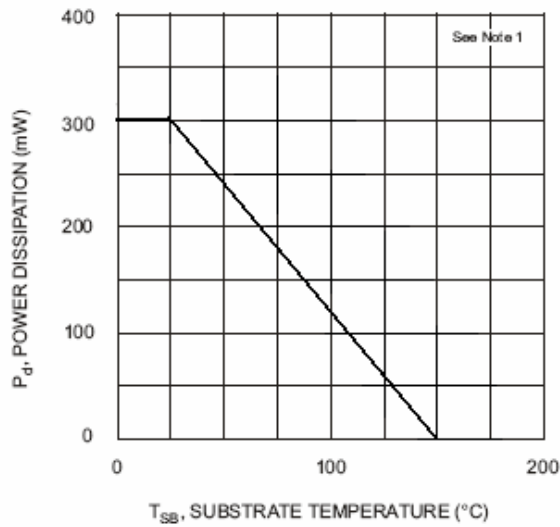

Fig. 1, Power Derating Curve

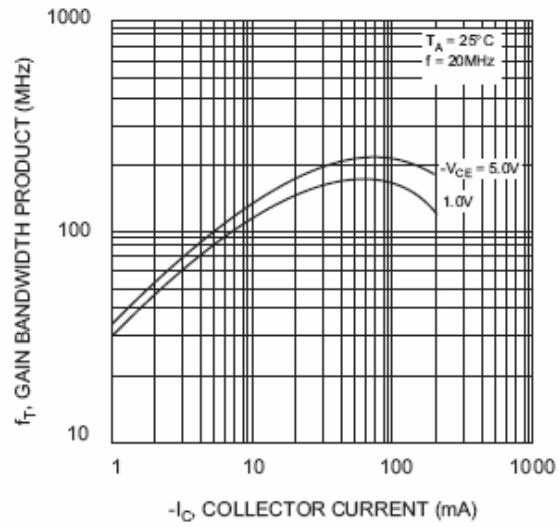

Fig. 2, Gain-Bandwidth Product vs Collector Current

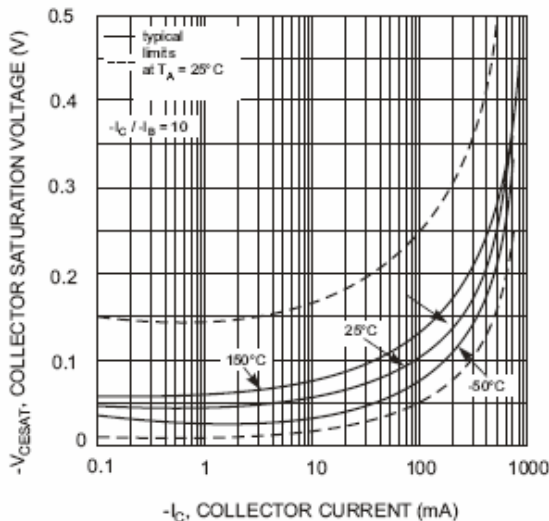

Fig. 3, Collector Sat Voltage vs Collector Current

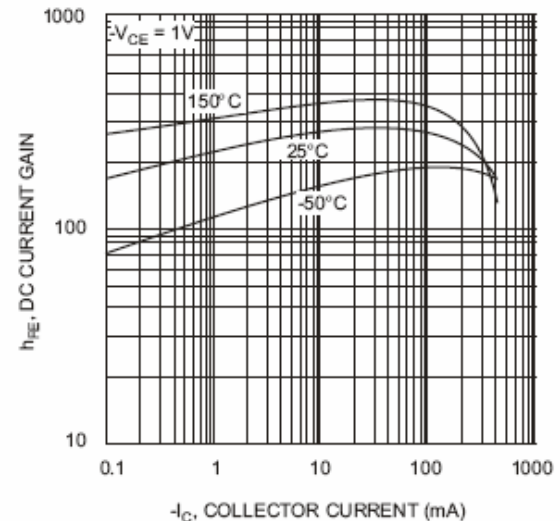

Fig. 4, DC Current Gain vs Collector Current

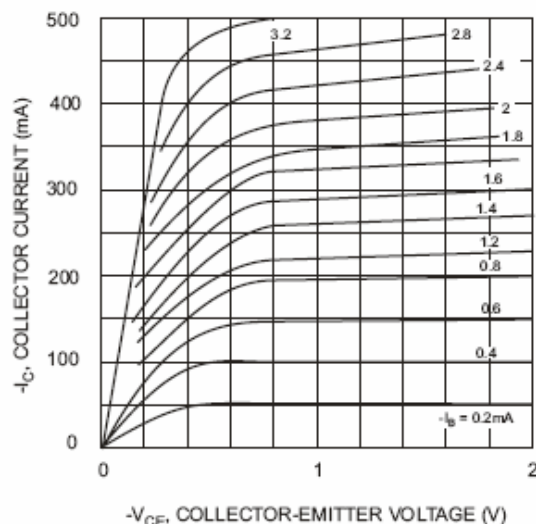

Fig. 5, Typical Emitter-Collector Characteristics

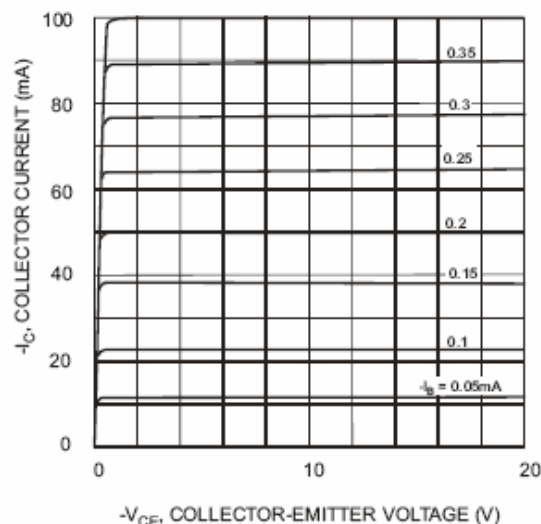

Fig. 6, Typical Emitter-Collector Characteristics